

# Koken®



ENGLISH



GERMAN



FRENCH

**2020-21**  
*Koken* TOOL CO., LTD.





# INDEX

**Z-SERIES**  
Z-SERIE  
SERIES-Z

**P021 - 036**



Z-SERIES

**HAND SOCKETS**  
HAND STECKSCHLÜSSEL  
DOUILLES À MAIN

**P037 - 130**



HAND

**TITAN-SOCKETS & ACCESSORIES**  
TITAN STECKSCHLÜSSEL UND ZUBEHÖRTEILE  
DOUILLES ET ACCESSOIRES TITAN

**P131 - 132**



TITANIUM

**ACCESSORIES**  
ZUBEHÖRTEILE  
ACCESSOIRES

**P133 - 168**



ACCESSORIES

**SCREWDRIVERS**  
SCHRAUBENDREHER  
TOURNEVIS

**P169 - 174**



SCREWDRIVERS

**IMPACT SOCKETS**  
IMPACT STECKSCHLÜSSEL  
DOUILLES IMPACT

**P175 - 246**



IMPACT

**SLEEVE-DRIVE SOCKETS**  
SLEEVE-DRIVE STECKSCHLÜSSEL  
DOUILLES, SLEEVE DRIVE

**P247 - 253**



SLEEVE-DRIVE

**SOCKETS WITH TURNABLE PLASTIC PROTECTORS**  
STECKSCHLÜSSEL MIT DREHBAREN SCHUTZHÜLSEN AUS KUNSTSTOFF  
DOUILLES A PROTECTIONS PLASTIFIEES

**P257 - 262**



PROTECTOR

**INDUSTRIAL SOCKETS**  
STECKSCHLÜSSEL, INDUSTRIE-AUSFÜHRUNG  
CLÉS À DOUILLES, FINISSAGE INDUSTRIEL

**P263 - 268**



INDUSTRIAL

**AUTOMOTIVE TOOLS**  
WERKZEUGE FÜR KFZ UND NUTZFAHRZEUGE  
OUTILS POUR POIDS LOURDS ET VÉHICULES UTILITAIRES

**P269 - 290**



AUTOMOTIVE

**MOTORCYCLE TOOLS**  
MOTORRAD WERKZEUGE  
OUTILLAGE MOTO

**P291 - 294**



MOTORCYCLE

**TOOLS FOR CONSTRUCTION SITES**  
WERKZEUGE FÜR DAS BAUGEWERBE  
OUTILLAGE POUR L'INDUSTRIE DU BÂTIMENT

**P295 - 301**



CONSTRUCTION

**SPARE PART SETS**  
ERSATZTEILSÄTZE  
PIÈCES DE RECHANGE

**P303 - 307**



SPARE PART

Pictograms Socket openings / Bit shape					
	FLAT DRIVE® (6-point)		TORX® (E)		TORX® (T)
	FLAT DRIVE® (12-point)		NUT GRIP® / TORX® (E)		Tamper-Resistant TORX® (TH)
	NUT GRIP®		TORXplus® (EP)		TORXplus® (IP)
	Surface Drive		LH-STIX® (LH-S)		Tamper-Resistant TORXplus® (IPR)
	PATHFINDER®		Bit Holder		Triple-Square(XZN)
	Flare Nut		Phillips		Triple-Square with Hole(XZN)
	Square		Slotted		Ribe-CV
	Double Square		Hexagon		POLYDRIVE
	Stud Bolt Puller		PZ		Double-Hexagon
	NUTTWISTER®		Square Male		Socket Set on Rail

Pictograms Mechanics / Specification					
	S.O.D.H-System®		Thin-Walled		1/4"(6.35mm) Sq. Dr.
	S.O.D.H-System® (4750 series)		with Magnet		3/8"(9.5mm) Sq. Dr.
	Two-Step Dog		20 tooth Gear		1/2"(12.7mm) Sq. Dr.
	Three-Step Dog		24 tooth Gear		5/8"(16.9mm) Sq. Dr.
	Quick Release Button		30 tooth Gear		3/4"(19.0mm) Sq. Dr.
	Flexible Head		36 tooth Gear		1"(25.4mm) Sq. Dr.
	Swivel Head		44 tooth Gear		1.1/2"(38.1mm) Sq. Dr.
	L/R Marking		45 tooth Gear		2.1/2"(63.5mm) Sq. Dr.
	Oval Shape Shank		60 tooth Gear		3.1/2"(88.9mm) Sq. Dr.
	Wobble-Fix				Caution



Reproduction in whole or in part without proper and prior authorization is prohibited.

Der Nachdruck, im ganzen oder auch auszugsweise, bedarf unserer ausdrücklichen, vorherigen Genehmigung.

La reproduction de ce catalogue en tout ou en partie sans autorisation préalable est interdite.

Specifications or designs of any product in this catalogue are subject to change without notice.

Wir behalten uns das Recht vor, jedes in diesem Katalog gezeigte Werkzeug, auch ohne vorherige Ankündigung, in Ausführung und Design ändern zu dürfen.

Nous nous réservons le droit de modifier les modèles et les dimensions des outils présentés dans ce catalogue et ce sans autre notification préalable.



■ TEST AND LABORATORY  
 ■ TESTLABOR  
 ■ TEST AU LABORATOIRE

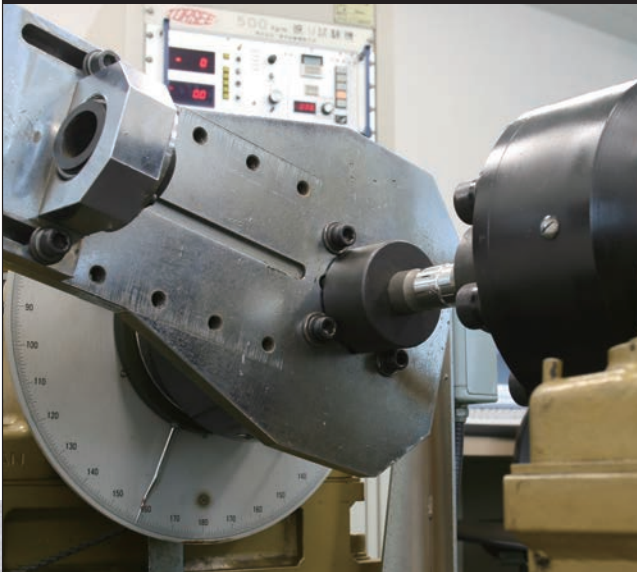

Ko-ken uses a variety of test equipment. Strength is measured by the Static Load Test Machine that can measure torque load up to 5,000Nm. Durability is measured by the Cyclic Test Machine and corrosion resistance testing is done by the Salt Spray Test Machine. The test results are used to improve our standard products and assist with new product design and development.

Wir verfügen über die verschiedensten Testgeräte:  
 -Die Festigkeitseigenschaften der Werkzeuge werden mit einer statischen Drehmoment-Testmaschine, die Prüfdrehmomente bis 5.000Nm erzeugen kann, überprüft.  
 -Die Dauerbelastbarkeit wird mit einer Testmaschine durchgeführt mit der die Werkzeuge zyklisch in langen Testreihen belastet werden.  
 - Der Korrosionsschutz wird regelmäßig mittels Salzsprühnebelprüfung kontrolliert.  
 Die gewonnenen Testergebnisse ermöglichen eine stetige Verbesserung der Standardwerkzeuge und helfen bei der Entwicklung neuer Produkte.

Ko-ken utilise plusieurs types de tests.  
 La résistance est mesurée par une installation de test à charge statique d'une capacité de 5.000 Nm. La durée de vie est déterminée par une machine à cycles et la résistance à la corrosion par une installation à projection de sel.  
 Les résultats de ces tests sont destinés à améliorer nos produits standards et à assister au développement de nouveaux produits.



■ DESIGN AND DEVELOPMENT  
 ■ ENTWICKLUNG UND DESIGN  
 ■ DESIGN ET DEVELOPPEMENT

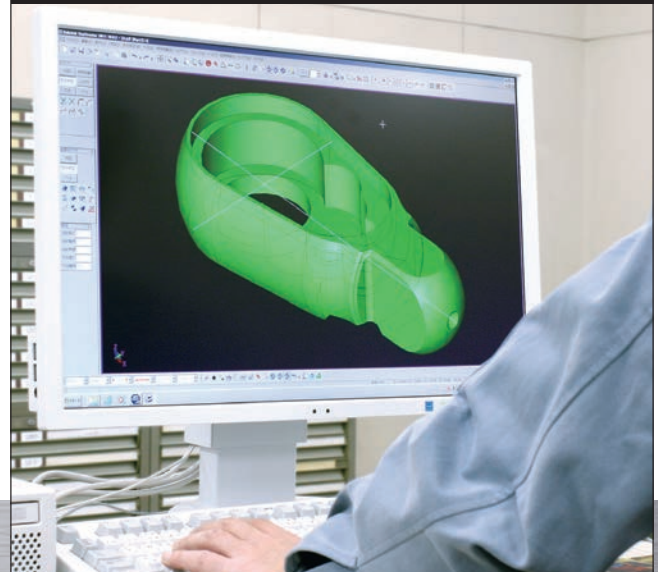

The 3D-CAD is used to improve standard products, designing new products and making customized items for special requirements. Trial products are regularly developed, manufactured and tested to improve the durability, appearance and functionality of all tools produced by Ko-ken.

3D-CAD Programme helfen uns sowohl, bei der Weiterentwicklung unserer Standardwerkzeuge, als auch beim Designen neuer Produkte und beim Entwerfen von Sonderanfertigungen.  
 Um die Zuverlässigkeit und Funktionalität unserer Werkzeuge zu verbessern, werden ständig Versuchswerkzeuge gefertigt.

La technique CAD-3D est utilisée pour l'amélioration des produits standards, le design des nouveaux produits et la réalisation d'outils spéciaux.  
 Des séries d'essai sont régulièrement développées, fabriquées et testées pour améliorer l'apparence et la fonctionnalité de tous les produits Ko-ken.



■ FORGING  
 ■ SCHMIEDEN  
 ■ FORGEAGE



The Forming machines are used for the forging process. These machines can produce mass quantities of sockets and parts with high accuracy that ordinary drop forging machines can not achieve. On the other hand, ordinary forging machines are also used for small production runs.

Zum Schmieden verwenden wir eigene Umformmaschinen.

Diese Maschinen werden zur Produktion großer Stückzahlen von Steckschlüsseln und Betätigungswerkzeugen verwendet mit einer Genauigkeit, die mit normalen Gesenkschmiede Maschinen nicht gewährleistet werden kann.

Bei kleineren Fertigungsserien werden zur Fertigung auch kleinere Gesenkschmiedemaschinen verwendet.

Des machines de formage à froid sont utilisées. Ces machines peuvent produire en masse les douilles et accessoires avec une précision supérieure à la forge conventionnelle. Toutefois, pour des petites séries, des machines à forger traditionnelles sont également utilisées.



■ TURNING  
 ■ DREHEN  
 ■ TOURNASAGE



The forged steel is turned into required shapes and dimensions. The MC (Machining Center) operates with extraordinary speed and precision. The article number, size, logo, production number, and MADE IN JAPAN are marked on the products after the turning process has been completed.

Der geschmiedete Stahl wird nun auf die endgültige Form abgedreht.

Unser Maschinenzentrum arbeitet hier mit außergewöhnlicher Geschwindigkeit und Präzision.

Nach dem Drehvorgang wird das Werkzeug mit Artikelnummer, Abmessung, Logo, Produktionsnummer und MADE IN JAPAN markiert.

Après la forge, les pièces sont usinées à la bonne dimension par tournage. Les centres d'usinage travaillent avec une précision et une vitesse extraordinaire.

Le numéro d'article, la dimension, le logo Ko-ken, un numéro de production ainsi que la mention « Made in Japan » sont gravés sur le produit après tournage.



■ HEAT TREATMENT  
■ HÄRTEN  
■ DURETE



To make the tools stronger and more durable, proper heat treatment is critically important. The temperature and the time of the heat treatment are strictly regulated by a very accurate control device.

Um die optimale Stabilität und Festigkeit der Werkzeuge zu erreichen ist der Härtingsprozess der Werkzeuge von höchster Wichtigkeit.

Die hohe Genauigkeit von Temperatur- und Dauer der Wärmebehandlung werden durch sehr genaue Regeleinrichtungen in den Härteöfen erreicht.

Pour la résistance et la dureté de l'outil, un traitement thermique adapté est indispensable. Les températures et la dureté de traitement sont très précisément contrôlées.



■ INSPECTION  
■ MESSEN UND PRÜFEN  
■ CONTRÔLE



Our products are periodically checked at each production process by inspection devices. Highly accurate 3-D measuring instruments are used to inspect and confirm dimensions.

Unsere Produkte werden periodisch nach jedem Produktionsprozess überprüft. Hierzu verwenden wir sehr genaue 3D Messgeräte.

Nos produits sont contrôlés périodiquement à chaque étape de leur fabrication.

Des instruments de mesure en 3D, très précis sont employés pour la vérification des dimensions.





## FLAT DRIVE®

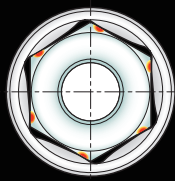

Flat Drive is designed to guarantee a flat surface contact between the socket and the bolt/nut.  
 The Flat contact reduces wear and allows to transmit a higher torque value.  
 The Flat Drive System is also used for the square drive end as well as the hexagonal or bi-hexagonal openings of the socket.

Das Flat Drive Design sorgt für die optimale Kraftübertragung zwischen den Flächen des Steckschlüssels und der Schraube. Dies erlaubt eine Übertragung von höheren Drehmomenten. Das Flat Drive System findet ebenfalls bei allen Antriebsvierkanten sowie bei 6-kant und 12-kant Profilen Verwendung.

Le profil Flat Drive garantit un contact optimal entre la douille et l'écrou. Ce contact « à plat » réduit l'usure et permet la transmission d'un couple plus élevé. Ce système Flat Drive est utilisé pour tous les carrés conducteurs ainsi que pour toutes nos douilles 6-pans et 12-pans.



# SOCKETS STECKSCHLÜSSEL DOUILLES



## NUT GRIP®



Twin balls at the 6-point opening hold bolt/nut tightly for safe and reliable work.

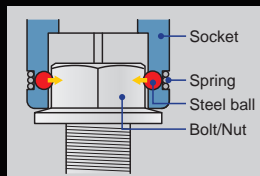

Die zwei Kugeln in der 6-kant Öffnung unserer NUT GRIP Steckschlüssel halten die Schraube sicher im Steckschlüssel. Dies erlaubt ein Arbeiten auch an schwer zugänglichen Stellen.

Les 2 billes dans l'ouverture du 6-pans de la douille retiennent l'écrou de manière sûre et efficace.

## SURFACE DRIVE



Surface drive sockets are designed to retain contact with the flat sides of the nut in order to transmit higher torque and reduce nut wear.

These sockets are ideal for using on polished nuts, aluminum nuts and nuts with worn out points.

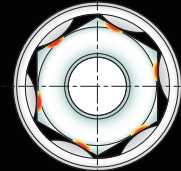

Das Profil unserer Surface-Drive Steckschlüssel greift die Schraube an deren Flächen.

Dies sichert eine höhere Kraftübertragung und verhindert ein Durchrutschen des Steckschlüssels. Diese Steckschlüssel eignen sich besonders für polierte Schrauben, Aluminium Schrauben und Schrauben bei denen die Ecken bereits abgerundet sind.

Notre profil Surface Drive assure le contact entre la douille et les plats de l'écrou. Ceci réduit l'usure et permet la transmission d'un couple plus élevé. C'est une solution idéale pour les écrous polies, celles en aluminium ou arrondies.

## PATHFINDER®



The beveled flats of the 6-point opening of the PATHFINDER socket engage the nut almost immediately. PATHFINDER sockets are ideal for using with power tools in automatic assembly processes, as the power tool does not have to be totally stopped for the socket to engage the nut.

Da die Maschine nicht nach jedem Schraubvorgang angehalten werden muss, ergibt sich eine erhöhte Produktivität, die sich bei vollautomatischen Maschinen (Mehrspindelschrauber) ganz besonders auswirkt.

Les parois en biais du 6-pans des douilles PATHFINDER assurent l'engagement quasi immédiat de l'écrou. Le fait de ne pas devoir arrêter la machine après chaque serrage procure un gain de productivité particularité appréciable dans les chaînes de montage automatiques.



# RATCHET HANDLE KNARRENGRIFFE MANCHE À CLIQUET



**J-Type**  
Rubber Grip  
Gummigriff  
Manche en matière plastique



**P-Type**  
Plain Grip  
Glatter Griff  
Manche lisse



**N-Type**  
Knurled Grip  
Gerändelter Griff  
Manche moletée



### S.O.D.H.-System®

Two dogs are located in the ratchet body so that the dogs and springs are held securely in place, allowing the reversing lever and dog to switch smoothly.

The torque load on the gear is transmitted vertically to the dog, and in turn, down the ratchet handle. This mechanism

locks gears tightly in place while torque is being applied, thus avoiding any gear slippage.

Die zwei Sperrklinken sind fest im Knarrenkörper verankert, die Federn sind dadurch fest fixiert.

Die Umschaltung der Knarre erfolgt leicht und sicher.

Die Kraft des Knarrenzahnrad wird vertikal auf die Sperrklinken übertragen, dadurch wird das Überspringen des Knarrenmechanismus sicher vermieden.

Les 2 rochets sont insérés dans le corps du cliquet. De ce fait les ressorts sont également fermement fixés. L'inversion se produit sans à-coups. Ce mécanisme assure aussi une transmission du couple sans risque de ripage.



### Two-Step Dog

Two flats hold two teeth of the ratchet gear, thus increasing the maximum torque load of the ratchet compared with a single-step system.

Die Kraft wird über zwei Zähne des Knarrenzahnrades übertragen. Dies erlaubt eine höhere Kraftübertragung gegenüber Knarren mit einem Zahn Mechanismus.

La force est transmise par les deux dents du mécanisme. Ceci permet un couple plus élevé par rapport aux systèmes à une seule dent .



### Three-Step Dog

Two dogs are set in the same axis, and the three teeth hold the ratchet gear.

The enlarged contact area produces an about 10% higher torque value and the S.O.D.H.-System provides smooth and light movements.

Die scharnierartig eingelagerten Sperrklinken haben jetzt jeweils drei Zähne im Eingriff. Die dadurch vergrößerte Greiffläche erhöht das maximale Drehmoment um ca. 10%. Auch diese Knarre besticht durch ihren leichten und geschmeidigen Lauf.

Les deux rochets étant placés sur le même axe, les trois dents de l'engrenage sont engagées en permanence. Ce système assure une augmentation de 10% du couple maximum admissible. Ce cliquet se caractérise également par son fonctionnement souple et sans à-coup.



**SHAPE OF HANDLE**  
**FORMGEBUNG DER GRIFFE**  
**MODELE DE POIGNEE**

---



## OVAL SHAPE SHANK



Unique designed oval shape shank provides extra strength and durability.

Der einzigartige ovale Schaftquerschnitt in Belastungsrichtung erhöht die Stabilität und Widerstandsfähigkeit.

La section ovale, orientée dans le sens de l'effort, confère à cet outil une résistance et une durée de vie incomparable.

## KNURLING



Rotation and general handling of extensions with oily hands is greatly improved with the **Ko-ken** developed 6 point knurling. Also the **Ko-ken** 6 point knurling stops the extensions from rolling around the work area.

Durch die von **Ko-ken** entwickelte 6 fache Rändelung wird die Handhabung deutlich erleichtert.

Außerdem wird das Herumrollen der Verlängerungen wirksam verhindert.

La manipulation des rallonges est grandement facilitée par le profil moleté développé par **Ko-ken**. Ce même profile empêche le roulement intempestif des rallonges sur le plan de travail.



## WOBBLE-FIX



### TWO WAY USAGE

- a) In a fixed position, as a normal extension bar
- b) In a half-fixed position, as a flexible extension bar providing a 15° angle operation.

### Winkelverlängerungen lassen sich in zwei Einstellungen verwenden

- a) voll eingesteckt und starr
- b) halb eingesteckt, mit einem Arbeitswinkel von 15°.

### Deux utilisations possibles

- a) comme rallonge normale, dans une position fixe
- b) comme une rallonge angulaire avec une possibilité d'inclinaison jusqu'à 15°

Fix

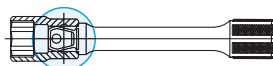

Wobble

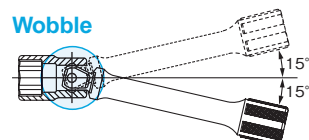



# STUD BOLT PULLER / SETTER STEHBOLZENAUSDREHER UND STEHBOLZENSETZER EXTRACTEURS DE GOUJONS



## STUD BOLT PULLER STEHBOLZENAUSDREHER DEGOUJONNEUSES



Hexagon body design can lessen the excessive load on cages and rollers inside the pullers.

Der neue Körper mit sechs Walzenmulden verteilt den Druck auf den Käfig und die Walzen weitaus vorteilhafter.

La forme hexagonale du corps améliore les tolérances.

Elle répartit l'effort de façon plus uniforme sur la cage et les rouleaux.



## STUD BOLT SETTER STEHBOLZENSETZER MONTE-GOUJONS



A special socket for installing a stud bolt.

Inside steel ball prevent the stud bolt stuck onto the socket. After installing a stud bolt, turn to anti-clockwise to removing the socket.

Spezialwerkzeug zum Setzen von Stehbolzen. Der Bolzen trifft im Werkzeug nur auf die gehärtete Stahlkugel, was die Kontaktfläche verringert. Nach dem Setzen des Stehbolzens kann das Werkzeug im Linkslauf vom Stehbolzen abgezogen werden.

Douilles spéciales pour monter les goujons. Le goujon est en contact avec une bille d'acier pour l'empêcher d'adhérer à la douille. Après avoir posé le goujon, tourner dans le sens antihorlogique pour le retirer

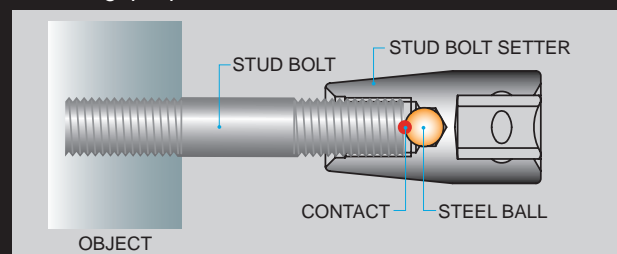



# ATTACK DRIVER®

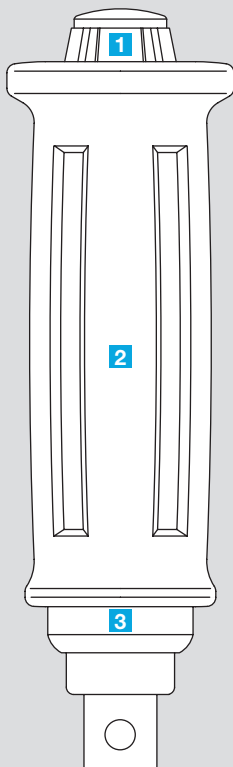

## 1 Black Finish - Schwarze Schlagplatte - Tête de frappe noire



Black finished head prevents peeling off the chrome plate by striking the head.  
Der Schlagkopf wurde geschwärzt, um das Abblättern von Chrompartikeln zu verhindern.

La finition noire de la tête évite l'écailage du chrome lors de la frappe.



## 2 Original Body Shape - Einzigartige Formgebung - Forme unique du corps



Original design of the body achieved higher grip.

Die Gestaltung des Handschlagschrauberkörpers erhöht Führung und Griffigkeit des Werkzeuges.

Le dessin original du corps permet une meilleure prise en main de l'outil.

## 1 3 Heat Treatment - Wärmbehandlung - Traitement thermique

Special heat treatment is applied on the body. Hardness of striking part is slightly softer to prevent cracks.

On the other hand, Cam part converts the striking power to twisted by striking with hammer, therefore, this part is finished with higher hardness to improve anti-wear.

Besondere Aufmerksamkeit wurde der Wärmbehandlung des Körpers gewidmet, indem die Härte des Schlagendes leicht verringert wurde, um ein Reißen durch Hammerschläge zu vermeiden. Dagegen wurde die Härte und somit die Belastbarkeit in dem Teil des Körpers erhöht, wo der Schlag in Drehkraft umgesetzt wird.

Un traitement thermique spécifique est appliqué sur le corps de l'outil. La dureté des parties de frappe est légèrement inférieure pour diminuer le risque de casse. D'un autre côté, le mécanisme qui transforme la force de frappe en rotation est plus dure pour augmenter la résistance à l'usure.

## 3 Spring - Feder - Ressort

Stronger spring is adapted to convert the striking power efficiently to twisting power.

Eine extrem widerstandsfähige Feder sorgt für die unmittelbare Übertragung der Schlagkraft und ihre Umsetzung in wirksame Drehkraft.

Un ressort très résistant est monté sur l'outil pour convertir la force de frappe en force de torsion très efficace.





# FREE-TURN GRIP



## SPINNING CROSS WRENCH DREHBARER KREUZSCHLÜSSEL CLE EN CROIX RAPIDE



The shaft of cross wrench turns freely inside the knurled grip. The cross bar is removable for easy storage in a compact space.

Der Schaft des Kreuzschlüssels dreht sich frei in dem kordierten Griff. Die Querstange kann entnommen werden, das erlaubt eine platzsparende Aufbewahrung (z.B. im Fahrzeug)

La tige de la clé tourne librement dans sa poignée gaufree. La barre transversale est démontable pour le rangement aisé de l'outil.



## FLEXIBLE SPEEDER GELENKGRIF-FWINDE VILEBREQUIN RAPIDE

Free-turn grip allows speedy removal or replacement of wheel nuts. It can also be used as a hinge handle to tighten or loosen the nuts.

Der frei laufende Griff ermöglicht eine schnelle Radmontage. Das Werkzeug kann zusätzlich als Gelenkgriff verwendet werden.

La poignée à rotation libre permet l'enlèvement et la pose rapide des écrous de roue. Elle peut également être utilisée comme poignée articulée.



## SPINNING SLIDE T-HANDLE FREILAUF T-GRIFF POIGNEE EN T RAPIDE

The knurled grip is attached in the middle of shaft for free turning. Oval shaped cross bar prevents the bar from turning inside the shaft during use.

Der kordierte Freilauf-Griff befindet sich in der Mitte des Schaftes. Der Quergriff mit ovalem Querschnitt verhindert das Verrutschen.

La poignée gaufree est fixée au milieu de la tige et est à rotation libre. La barre transversale est de forme ovale pour l'empêcher de tourner pendant l'utilisation.





# IMPACT WHEEL NUT SOCKET IMPACT RADMUTTERN STECKSCHLÜSSEL DOUILLES POUR ÉCROUS DE ROUE, IMPACT



## PLASTIC PROTECTOR KUNSTSTOFF HÜLSE PROTECTION EN PLASTIQUE



A detachable plastic protector is fitted to the socket to prevent damage to the wheel when working in tight areas.

The socket size and Ko-ken Mark printed on the shaft makes it easier to see if the socket is still rotating or stopped.

Zum Schutz empfindlicher Leichtmetallfelgen ist eine drehbare und abnehmbare Kunststoff Hülse an dem Steckschlüssel montiert. Die aufgedruckten Markierungen am Werkzeugschaft zeigen außerdem ob das Werkzeug steht oder rotiert.

La douille est pourvue d'un insert en plastique détachable. Il sert à prévenir tout dommage aux jantes lors de l'utilisation des douilles.

Le marquage sur la tige rend l'identification des douilles très facile.

## EXTRA THIN-WALLED EXTRA DÜNNWANDIG PAROIS EXTRA MINCES



Thin-walled shape and 110mm length gives extra reach for nuts recessed deep inside the wheel.

They are ideal for aluminum wheel nuts where access to nut is very tight. Colour coded shafts make size identification easy.

# SPARK PLUG SOCKET ZÜNDKERZEN STECKSCHLÜSSEL DOUILLES AVEC RESSORTS RETENUE POUR BOUGIES



## CLIP TYPE

This revolutionary new spark plug socket is designed to securely grip a spark plug at its hexagonal part by two stainless spring clips.

An internal brass guide holds the clips in place, which ensures perfect alignment of the spark plug into the threaded plughole of the cylinder head, thus preventing thread damage.

The brass guide also eliminates stress loading and possible damage to the ceramic insulator of the spark plug.

Zwei solide Federn aus rostfreiem Stahl fassen den Sechskant der Zündkerze und drücken ihn an den Anschlag der Messing-Führungsbuchse. Jetzt sitzt die Kerze genau senkrecht zur Achse des Steckschlüssels. Das Einschrauben kann ohne Beschädigung der Gewindegänge im Motorblock und ohne Druck auf den Isolator der Kerze erfolgen.

Deux puissants ressorts en acier inoxydable maintiennent la bougie sur sa partie hexagonale tout en l'appliquant contre la douille de guidage en laiton. L'alignement parfait de la bougie dans l'axe de l'outil permet à l'opérateur de poser celle-ci avec beaucoup de précision en réduisant au maximum les risques d'endommagement au filetage du bloc ainsi qu'à la partie en céramique de la bougie.

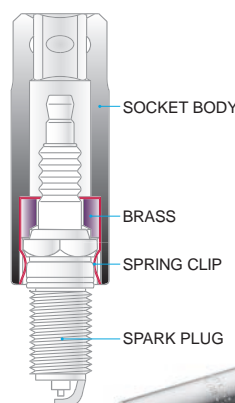

## Universal Joint Universal Gelenk Joint universel



### Hexahedral engagement achieved with compact design

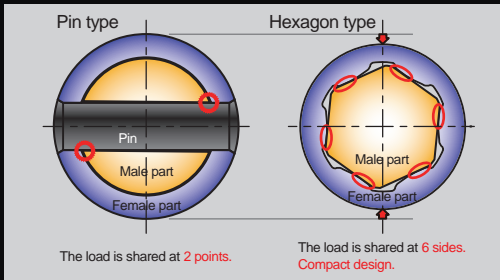

Ball type universal joints use a new structure of joint mechanism without a pin. Being connected by mutually engaged hexahedrons, the load is dispersed across the whole outer circumference. High durability is obtained with this innovative, compact design.

Unsere neuen Kugelgelenke haben einen Gelenkmechanismus ohne Bolzen. Durch die miteinander verbundenen sechs Flächen wird die Last über den gesamten Außenumfang verteilt. Diese innovative kompakte Bauweise erhöht die Lebensdauer des Gelenkes erheblich.

Nos joints articulés utilisent un nouveau mécanisme d'articulation sans boulons. Grâce aux six surfaces interconnectés, la charge est répartie sur toute la circonférence extérieure. Cette conception innovante et compacte augmente considérablement la durée de vie de l'articulation.



## Locking Adaptor VERRIEGELUNGSADAPTER L'ADAPTATEUR DE VERROUILLAGE



Impact sockets can be attached or detached on the LOCKING ADAPTOR for safety just by sliding the holder rather than using a pin and an O-ring. It can reduce the time to change a socket, especially when you need to use a variety of socket sizes.

Die Kraftschraubereinsätze werden durch einfaches Verschieben der Hülse am Adapter, ohne Verwendung von Stift und O-Ring, sicher gehalten bzw. entriegelt. Die Zeit für den Wechsel eines Steckschlüssels wird dadurch deutlich verkürzt, insbesondere wenn Sie eine Vielzahl von verschiedenen Abmessungen verwenden müssen.

Vos douilles à chocs peuvent être facilement maintenues et libérées en déplaçant le support de l'adaptateur sans devoir utiliser la goupille et le joint. Le temps nécessaire pour changer une clé à douille est considérablement réduit, surtout si vous devez utiliser une variété de dimensions différentes.

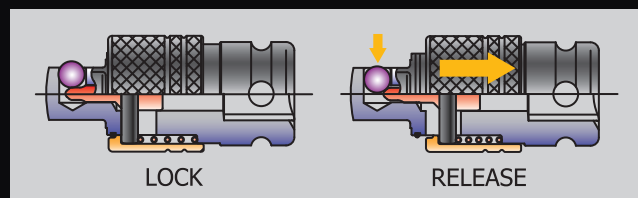



## NUTTWISTER®

The NUTTWISTER's six teeth have a special helical structure that tapers inward, locking onto the rounded-off bolt or nut for removal. NUTTWISTER can be applied to any round bolts like stud bolts, cap bolts, provided the correct size is used and the bolt or nut is unbroken.

Die sechs Zähne des NUTTWISTER's haben eine spezielle schraubenförmige Struktur, die sich nach innen verjüngt und sich dadurch mit der abgerundeten Schraube oder Mutter verbeißt.

Der NUTTWISTER kann auf alle Rundbolzen wie Stehbolzen und Zylinderschrauben verwendet werden, unter Voraussetzung dass die richtige Größe verwendet wird und die zu lösende Schraube oder Mutter nicht gebrochen ist.

Les six dents du NUTTWISTER ont une structure hélicoïdale spéciale qui se rétrécit vers l'intérieur et mord avec la vis ou l'écrou arrondi.

Le NUTTWISTER peut être utilisé sur tous les boulons ronds tels que les boulons filetés et les vis à tête cylindrique, à condition que la taille correcte soit utilisée et que la vis ou l'écrou à desserrer ne soit pas cassé.

## BOLTTWISTER®



Use the BOLTTWISTER to remove a broken bolt whose head has come off.

After drilling a hole in the center of the broken bolt, insert BOLTTWISTER into the hole and turn it counterclockwise until it sticks. The bolt can be removed by continuing to turn it.

Verwenden Sie unsere BOLTTWISTER um gebrochene Schrauben deren Kopf abgebrochen ist zu lösen.

Nachdem Sie ein Loch in der Mitte des gebrochenen Bolzens gebohrt haben, stecken Sie den BOLTTWISTER in das Loch und drehen ihn gegen den Uhrzeigersinn bis er klemmt.

Der Bolzen kann nun durch weiteres Drehen entfernt werden.

Utilisez notre BOLTTWISTER pour enlever une vis cassée dont la tête est cassée.

Après avoir percé un trou au centre du boulon cassé, insérez le BOLTTWISTER dans le trou et tournez le dans le sens inverse des aiguilles d'une montre jusqu'à ce qu'elle se bloque.

Le boulon peut maintenant être retiré en le tournant davantage.

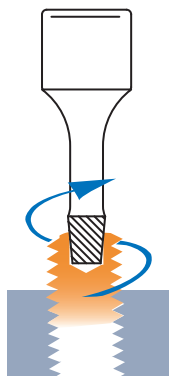

**TORX® / TORXplus® & LHSTIX®**

**TORX® / TORXplus®** and **LHSTIX®** are recognized as three of the most efficient fastening systems because of their ability to transfer greater torque, reduce end load and virtually eliminate tool slippage.

Durch die Fähigkeit größere Drehmomente zu übertragen sind **TORX® / TORXplus®** und **LHSTIX®** bekannt als die drei effizientesten Befestigungssysteme.

**TORX® / TORXplus®** et **LHSTIX®** sont reconnus comme étant trois systèmes de vissage particulièrement efficaces. Ils permettent en effet de transmettre des couples particulièrement élevés.

**TORX® & TORX plus®**



**TORX®** is a registered trademark of Acument Intellectual Properties, LLC.  
**TORX®** ist ein registriertes Markenzeichen der Firma Acument Intellectual Properties, LLC.  
**TORX®** est une marque déposée de Acument Intellectual Properties, LLC.  
**TORXplus®** is a registered trademark of Acument Intellectual Properties, LLC.  
**TORXplus®** ist ein registriertes Markenzeichen der Firma Acument Intellectual Properties, LLC.  
**TORXplus®** est une marque déposée de Acument Intellectual Properties, LLC.



**Koken TOOL CO., LTD.** holds the official license to use the trademark **TORX®**.  
**Koken TOOL CO., LTD.** hält die offizielle Lizenz um das Markenzeichen **TORX®** benutzen zu dürfen.  
**Koken TOOL CO., LTD.** est officiellement licencié pour l'usage de cette marque **TORX®**.  
**Koken TOOL CO., LTD.** holds the official license to use the trademark **TORXplus®**.  
**Koken TOOL CO., LTD.** hält die offizielle Lizenz um das Markenzeichen **TORXplus®** benutzen zu dürfen.  
**Koken TOOL CO., LTD.** est officiellement licencié pour l'usage de cette marque **TORXplus®**.

**LHSTIX®**



**LHSTIX®** is a registered trademark of OSG SYSTEM PRODUCTS CO., LTD.  
**LHSTIX®** ist ein registriertes Markenzeichen der Firma OSG SYSTEM PRODUCTS CO., LTD.  
**LHSTIX®** est une marque déposée de OSG SYSTEM PRODUCTS CO., LTD.  
**Koken TOOL CO., LTD.** holds the official license to use the trademark **LHSTIX®**.  
**Koken TOOL CO., LTD.** hält die offizielle Lizenz um das Markenzeichen **LHSTIX®** benutzen zu dürfen.  
**Koken TOOL CO., LTD.** est officiellement licencié pour l'usage de cette marque **LHSTIX®**.

Registered Trademarks / Eingetragene Warenzeichen / Marque déposée

**Koken®**



**Koken TOOL CO., LTD.®**

HIGH PERFORMANCE TOOLS OF CONVINCING QUALITY

山下工業研究所®

山下工研®

S.O.D.H-System®

Flatdrive®

**ATTACK DRIVER®**

HANDY-ENDY®

**PATHFINDER®**

**Nut Grip®**

LOCK NUT BUSTER®

NUT TWISTER®

BOLT TWISTER®

**Ko-ken Factory / Das Ko-ken Werk / L'usine Ko-ken**



**Warranty / Garantie / Garantie**

**WARRANTY**

The trade mark **Kokon** is your unqualified warranty against any defect in material or workmanship. Each **Kokon** tool is built to more than meet the requirements of its intended use and is carefully checked before leaving the factory. Any **Kokon** tool which fails because of defective material or workmanship will be repaired or replaced through your **Kokon** dealer, to the exclusion of any further liability.

**GARANTIE**

**Kokon** TOOL CO.,LTD. Shizuoka, Japan, garantiert Ihnen die einwandfreie Qualität und Ausführung ihrer Produkte. Jedes Werkzeug der Marke **Kokon** ist für Höchstleistungen konstruiert und wird vor Verlassen der Fabrik sorgfältig geprüft. **Kokon** TOOL CO.,LTD. repariert oder ersetzt über ihre Händler unter Ausschluss jeglicher weitergehenden Haftung jedes fehlerhafte **Kokon** Produkt kostenlos.

**GARANTIE**

La fabrique **Kokon** TOOL CO.,LTD. Shizuoka, Japon, garantit la qualité irréprochable et le traitement absolument impeccable des outils portant la marque **Kokon**. Chaque outil **Kokon** quittant la fabrique est contrôlé soigneusement. La fabrique s'engage à réparer ou remplacer gratuitement tout défaut de matière ou de fabrication par l'intermédiaire de ses distributeurs, à l'exception d'une responsabilité étendue.

**ISO9001**







SAFETY  
ADVISER

SICHERHEITS-  
RATGEBER

MESURES  
DE SÉCURITÉ

## General / Allgemeines / Généralités

- (a) Make sure you use the right type socket, whose opening fit the nut.  
Verwenden Sie immer den richtigen Steckschlüssel und überzeugen Sie sich davon, ob er auch auf die Mutter passt.  
Utilisez toujours la bonne clé et assurez-vous qu'elle est rigoureusement adaptée à l'écrou.
- (b) For use on electric or air IMPACT Wrenches select IMPACT Sockets only.  
Auf elektrischen oder pneumatischen Schlagschraubern dürfen nur hoch belastbare IMPACT-Steckschlüssel und Zubehörteile gesteckt werden.  
Sur des vis à fixer par machines à chocs pneumatiques ou électriques n'utilisez que des clés à douille IMPACT et des accessoires IMPACT capables de résister à une haute sollicitation.
- (c) When using nut runners or IMPACT Wrenches wear safety goggles.  
Tragen Sie bei der Anwendung von Schraubern stets eine Schutzbrille.  
En opérant avec des visseuses et des machines à chocs, portez toujours des lunettes de protection.
- (d) Plastic or rubber handles are not intended to act as insulation.  
Plastik-oder Gummigriffe stellen keinen Isolierschutz dar.  
Les poignées en plastique ou en caoutchouc ne garantissent aucune isolation électrique.
- (e) Never substitute a HAND Socket for a INDUSTRIAL Socket or an IMPACT Socket, or a INDUSTRIAL Socket for an IMPACT Socket.  
Nehmen Sie deshalb niemals anstelle eines INDUSTRIAL-oder IMPACT-Werkzeuges ein HAND-Werkzeug oder anstatt eines IMPACT-Werkzeuges ein INDUSTRIAL-Werkzeug.  
Ne vous servez donc jamais d'un outil à main au lieu d'un outil INDUSTRIAL ou IMPACT ou d'un outil INDUSTRIAL au lieu d'un outil IMPACT.
- (f) Items in this catalogue marked  can be loaded to torque values which may cause breakage. In the interest of your own safety always apply load evenly and progressively to avoid breakage and possible injury.  
Die mit  gekennzeichneten Artikel können bei Überbelastung zu Bruch gehen. Aus Gründen Ihrer eigenen Sicherheit sollten die betreffenden Werkzeuge nie ruckartig, sondern nach und nach belastet werden, um Bruch, und damit verbundene mögliche Verletzungen zu vermeiden.  
Il est possible d'appliquer aux articles marqués  des couples de serrage susceptibles d'occasionner leur rupture. Pour votre propre sécurité, veuillez toujours appliquer la charge d'une manière uniforme et progressive. Ceci pour éviter ruptures et accidents.
- (g) Make sure to lock the impact sockets on driving tools with Pin / O-Ring or C-Ring.  
Verwenden Sie Impact Steckschlüssel nie ohne Sicherungsring und Stift oder alternativ mittels unserer C-Ringe.  
Ne jamais utiliser de douille à choc sans sécurité. (Anneau et goupille ou crochet en C)

## Sockets / Steckschlüssel / Douilles

Sockets showing cracked walls, battered points or other marks of wear are to be replaced.

Steckschlüssel mit Haarrissen, abgestossenen Kanten oder mit anderen Verbraucherscheinungen sind umgehend zu ersetzen.

Les clés qui présentent des fissures capillaires, ou autres signes d'usure doivent être immédiatement changées.

## Ratchets/Handles / Knarren/Griffe / Cliquets/Poignées

A ratchet is not a hammer.

Eine Knarre ist kein Hammer.

Un cliquet n'est pas un marteau.

Never use loose pipes or other improvised attachments on handles for increased leverage.

Setzen Sie niemals lose Rohre oder andere Hilfsstücke auf Steckschlüsselgriffe, um dadurch eine höhere Drehkraft zu erzeugen.

Ne mettez jamais de tubes ou autres pièces auxiliaires sur les poignées des clés à douille dans le but d'obtenir un couple de serrage plus élevé.

## Extension Bars / Verlängerungen / Rallonges

The combination of several short extensions instead of one correct sized one is to be avoided.

Das Zusammenstecken von mehreren kurzen Verlängerungen als Ersatz für eine in der richtigen Länge ist unbedingt zu vermeiden.

Il faut absolument éviter d'utiliser plusieurs rallonges courtes au lieu d'une seule ayant la bonne longueur.

## Adaptors / Verbindungsstücke / Réducteurs

Adaptors are to be used reasonably. Be reminded that high torque potentials are reached when using a "down" adaptor, a bigger sized handle to a smaller drive socket. Always stay within safe limits.

Reduzierstücke sind mit Vernunft einzusetzen. Beachten Sie, dass bei der Verwendung von Reduzierstücken hohe Drehmomentwerte ausgelöst werden nämlich dadurch, dass grössere Griffe auf kleinere Steckschlüssel gesetzt werden. Bleiben Sie jeweils innerhalb der Sicherheitsgrenzen.

Les réducteurs doivent être utilisés avec modération. Il est à considérer qu'avec les réducteurs on obtient un couple de serrage élevé du fait que des poignées plus grandes sont appliquées sur des clés à douille plus petites. Ne dépassez pas les limites de sécurité.

**Z-SERIES  
Z-SERIE  
SERIES-Z**



# Z-Series : Feature

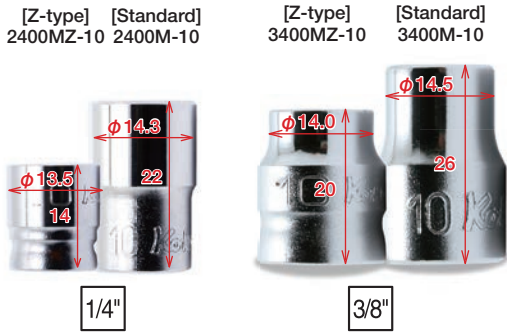

## COMPACT

2400MZ and 3400MZ are designed 5-9mm shorter than standard 2400M and 3400M which is ideal for working in confined and tight areas.

2400MZ und 3400MZ sind gegenüber unseren Standardausführungen 2400M und 3400M um 5-9mm kürzer. Dies erlaubt ein Arbeiten an schwer zugänglichen Stellen.

Les douilles 2400MZ et 3400MZ étant plus courtes de 5-9mm par rapport aux douilles standards, elles ont l'avantage de faciliter le travail dans des endroits étroits et difficilement accessibles.

## TOLERANCE-Hexagon Opening

The Hexagon openings of our Z-Sockets are produced with reduced tolerances (according to DIN/ISO) which achieve a more positive fit between bolt and socket.

Die Steckschlüsselöffnungen der Z-Serie werden mit geringeren Toleranzen (nach DIN/ISO) gefertigt um eine bessere, direktere Verbindung zwischen Schraube und Werkzeug zu gewährleisten.

Les douilles Ko-ken de la série Z sont fabriquées selon DIN/ISO comme toutes les douilles standards. Sauf que pour la série Z les tolérances sont plus restreintes afin d'atteindre un meilleur ajustement entre douille et vis.

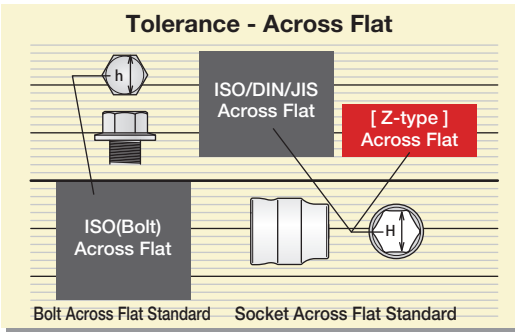

## TOLERANCE-Square Drive

To ensure a tighter fit between socket and handle, the male and female square drives are produced with shorter tolerances (according DIN/ISO).

Auch die Antriebsvierkante sind mit einer geringeren Toleranz (nach DIN/ISO) gefertigt um eine festere Verbindung zwischen Betätigungswerkzeug und Steckschlüssel zu ermöglichen.

Aussi les carrés mâles et femelles sont fabriqués avec des tolérances plus restreintes (selon DIN/ISO) afin de garantir une meilleure fixation entre cliquet et douille.

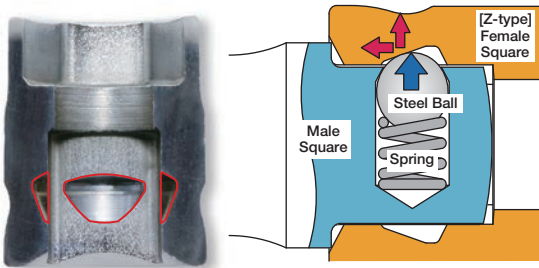
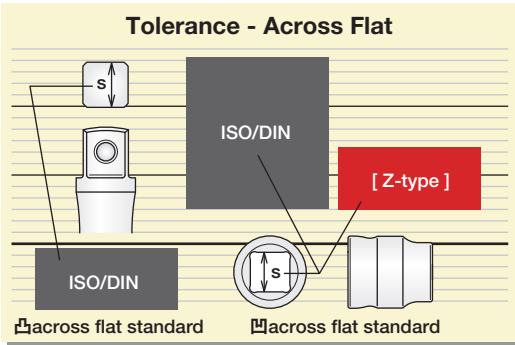

## BALL HOLDING GROOVE

The inventive Ball Holding system of the Z-series allows a secure connection between Socket and Handle.

Die Werkzeuge der Z-Serie verfügen über spezielle Kugelfangrillen, die eine noch sicherere Verbindung zwischen Betätigungswerkzeug und Steckschlüssel gewährleisten.

La série Z dispose d'une rainure de fixation pour bille spéciale, qui améliore nettement la fixation entre douille et cliquet.

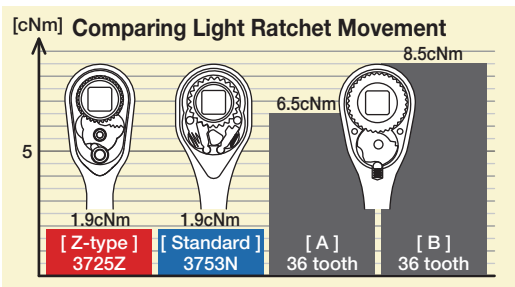

\* A, B : Other Brand

## RATCHET HANDLE

Smaller head with 36 tooth gear and light ratchet movement allow working in narrow spaces and confined areas.

Der schmalere Knarrenkopf, mit leicht gängigem 36-Zahn Getriebe erlaubt ein Arbeiten an engen schwer zugänglichen Stellen.

La tête de cliquet réduit et un mécanisme à 36 dents plus léger facilite le travail dans des endroits difficilement accessibles.



2400MZ (mm)	D <sub>1</sub> (mm)	D <sub>2</sub> (mm)	H (mm)	L (mm)	(g)	(pcs.)
4	6.4	11	3	14	6	10
4.5	7	11	3	14	6	10
5	7.6	11	3	14	6	10
5.5	8.2	11	3.5	14	6	10
6	8.8	11	3.5	14	6	10
7	9.9	11	3.5	14	6	10
8	11.1	11.7	4.5	15	7	10
10	13.5	12.5	7	15	8	10
11	14.7	13.2	7	15	9	10
12	15.9	14.4	7	15	11	10
13	17.1	15.6	7	15	14	10
14	18.3	16.8	7	15	16	10

RS2400MZ/12	12 Pieces Set/Rail 200mm	(g)
4, 4.5, 5, 5.5, 6, 7, 8, 10, 11, 12, 13, 14		228

2300XZ (mm)	D <sub>1</sub> (mm)	D <sub>2</sub> (mm)	H <sub>1</sub> (mm)	H <sub>2</sub> (mm)	L (mm)	(g)	(pcs.)
5.5	8.2	11	6	20	30	10	10
6	8.8	11	7	20	30	10	10
7	9.9	11	8	20	30	11	10
8	11.1	11.7	9	20	30	13	10
10	13.5	12.5	11	20	30	16	10
11	14.7	13.2	12	20	30	19	10
12	15.9	14.4	13	20	30	22	10
13	17.1	15.6	14	20	30	26	10
14	18.3	16.8	14	20	30	30	10

RS2300XZ/9	9 Pieces Set/Rail 200mm	(g)
5.5, 6, 7, 8, 10, 11, 12, 13, 14		290

2300MZ (mm)	D <sub>1</sub> (mm)	D <sub>2</sub> (mm)	H <sub>1</sub> (mm)	H <sub>2</sub> (mm)	L (mm)	(g)	(pcs.)
4	6.4	11	5	41	50	14	10
4.5	7	11	5.5	41	50	16	10
5	7.6	11	6	41	50	16	10
5.5	8.2	11	6.5	41	50	16	10
6	8.8	11	7	41	50	17	10
7	9.9	11	8	41	50	20	10
8	11.1	11.7	9	41	50	22	10
10	13.5	12.5	11	41	50	29	10
11	14.7	13.2	12	41	50	33	10
12	15.9	14.4	13	41	50	40	10
13	17.1	15.6	14	41	50	45	10
14	18.3	16.8	16	41	50	51	10

RS2300MZ/12	12 Pieces Set/Rail 200mm	(g)
4, 4.5, 5, 5.5, 6, 7, 8, 10, 11, 12, 13, 14		445

## 2400MZ 6-point Sockets 6-kant Steckschlüssel Douilles 6-pans

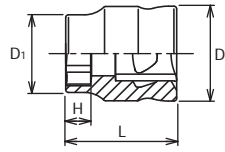

## RS2400MZ/12 Socket Set on magnetic Rail Steckschlüsselsatz auf Magnetschiene Jeu de douilles sur rail à aimant



## 2300XZ 6-point Sockets, Semi-Deep 6-kant Steckschlüssel, mittel-lang Douilles, semi-profondes 6-pans

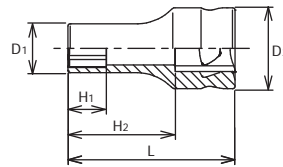

## RS2300XZ/9 Socket Set on magnetic Rail Steckschlüsselsatz auf Magnetschiene Jeu de douilles sur rail à aimant



## 2300MZ 6-point Deep Sockets 6-kant-Steckschlüssel, lang Douilles longues 6-pans

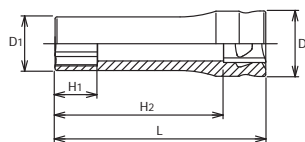

## RS2300MZ/12 Socket Set on magnetic Rail Steckschlüsselsatz auf Magnetschiene Jeu de douilles sur rail à aimant



## 2000Z-28 / -50

⊕ Phillips Bit Sockets  
Steckschlüssel für Kreuzschlitzschrauben Phillips  
Douilles tournevis pour vis à empreinte Phillips

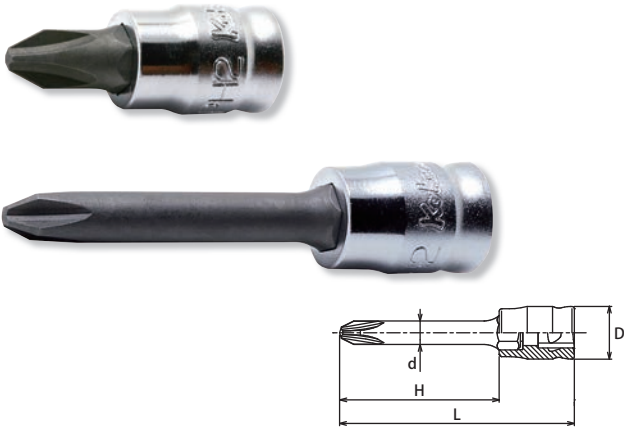

2000Z-28 (PH)	D (mm)	H (mm)	L (mm)	(g)	(pcs.)
1	11.2	12	28	9	10
2	11.2	12	28	10	10
3	11.2	12	28	10	10

2000Z-50 (PH)	D (mm)	d (mm)	H (mm)	L (mm)	(g)	(pcs.)
1	11.2	4	34	50	11	10
2	11.2	5	34	50	13	10
3	11.2	-	34	50	16	10

## 2005Z-25

⊖ Bit Sockets for Slotted Head  
Steckschlüssel für Schlitzschrauben  
Douilles tournevis pour vis à fente



2005Z-25	T x W (mm)	D (mm)	H (mm)	L (mm)	(g)	(pcs.)
5	1.0 x 5.5	11.2	9	25	9	10
6	1.2 x 6.5	11.2	9	25	10	10

## 2010MZ-25 / -50

⦿ Inhex Bit Sockets  
Steckschlüssel für Innensechskant-Schrauben  
Douilles tournevis pour vis 6-pans creux

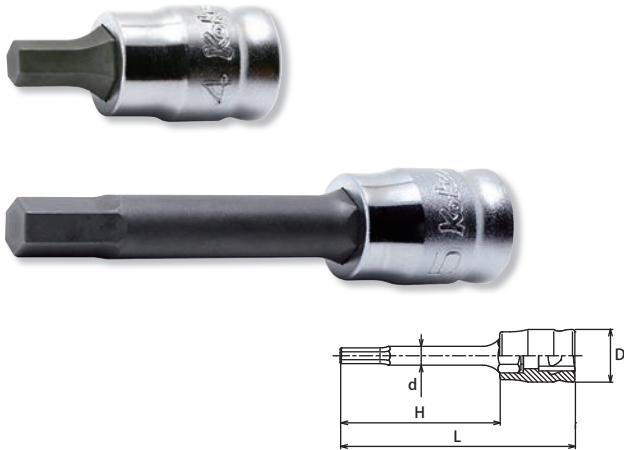

2010MZ-25 (mm)	D (mm)	H (mm)	L (mm)	(g)	(pcs.)
3	11.2	9	25	9	10
4	11.2	9	25	9	10
5	11.2	9	25	10	10
6	11.2	9	25	10	10

2010MZ-50 (mm)	D (mm)	d (mm)	H (mm)	L (mm)	(g)	(pcs.)
3	11.2	4	34	50	11	10
4	11.2	5	34	50	13	10
5	11.2	6	34	50	15	10
6	11.2	-	34	50	17	10

## RS20XXZ/9

⊕ ⊖ ⊗ Socket Set on magnetic Rail  
Steckschlüsselsatz auf Magnetschiene  
Jeu de douilles sur rail à aimant



RS20XXZ/9		9 Pieces Set/Rail 200mm	(g)
2000Z.28		1, 2, 3	213
2005Z.25		5, 6	
2010MZ.25		3, 4, 5, 6	

# 1/4"

Z-series  
Z-serie  
Series-Z

2025Z-28 (T)	D (mm)	H (mm)	L (mm)	(g)	(pcs.)
T10	11.2	12	28	9	10
T15	11.2	12	28	9	10
T20	11.2	12	28	9	10
T25	11.2	12	28	10	10
T27	11.2	12	28	10	10
T30	11.2	12	28	10	10
T40	11.2	12	28	11	10

2025Z-50 (T)	D (mm)	d (mm)	H (mm)	L (mm)	(g)	(pcs.)
T10	11.2	4	34	50	11	10
T15	11.2	4	34	50	11	10
T20	11.2	4.5	34	50	12	10
T25	11.2	5	34	50	13	10
T27	11.2	5	34	50	13	10
T30	11.2	5.6	34	50	15	10
T40	11.2	-	34	50	17	10

RS2025Z/7-L28	7 Pieces Set/Rail 200mm	(g)
T10, T15, T20, T25, T27, T30, T40		195

RS2025Z/7-L50	7 Pieces Set/Rail 200mm	(g)
T10, T15, T20, T25, T27, T30, T40		220

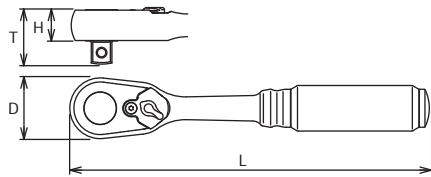

36

	D (mm)	T (mm)	H (mm)	L (mm)	(g)	(pcs.)
2725Z	20.5	17.1	9.5	114	79	2
2725Z-160	20.5	17.1	9.5	160	120	2

\* Renewal Kits → 2725RK → P305



2725Z  
2725Z-160

Reversible Ratchet  
Knarre, verstellbar  
Cliquet, réversible

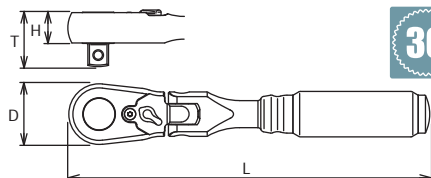

36  
Flexible Head

	D (mm)	T (mm)	H (mm)	L (mm)	(g)	(pcs.)
2726Z	20.5	17.1	9.5	114	103	2
2726Z-160	20.5	17.1	9.5	160	150	2

\* Renewal Kits → 2726RK → P305



2726Z  
2726Z-160

Flexible Ratchet, Reversible (Short)  
Gelenk-Knarre kurz, verstellbar  
Cliquet articulé court, réversible

2025Z-28 / -50

TORX® Bit Sockets  
TORX® Bit-Steckschlüssel  
Douilles tournevis, TORX®

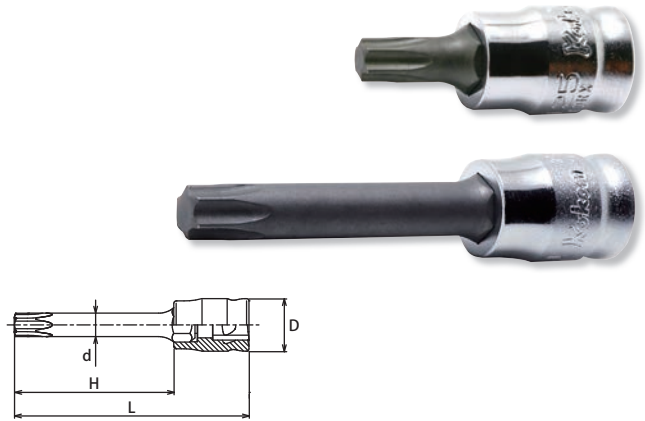

RS2025Z/7-L28  
RS2025Z/7-L50

Socket Set on magnetic Rail  
Steckschlüsselsatz auf Magnetschiene  
Jeu de douilles sur rail à aimant



Z-SERIES  
HAND  
TITANIUM  
ACCESSORIES  
SCREWDRIVERS  
IMPACT  
SLEEVE-DRIVE  
PROTECTOR  
INDUSTRIAL  
AUTOMOTIVE  
MOTORCYCLE  
CONSTRUCTION  
SPARE PART

## 2760Z

Extension Bars  
Verlängerungen  
Rallonges

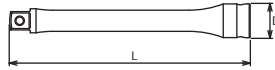

	D (mm)	L (mm)	(g)	(pcs.)
2760Z-50	11.5	50	21	10
2760Z-100	11.5	100	39	10
2760Z-150	11.5	150	58	10

## 2771Z

Universal Joint  
Gelenk-Einsatz  
Joint articulé



UNIVERSAL JOINT

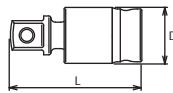

	D (mm)	L (mm)	(g)	(pcs.)
2771Z	11.7	29.9	15	10

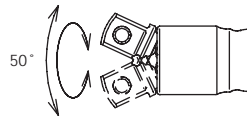

## 2772Z

Universal Double Joint  
Doppelgelenk-Einsatz  
Joint articulé double

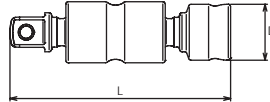

	D (mm)	L (mm)	(g)	(pcs.)
2772Z	11.7	46	26	10

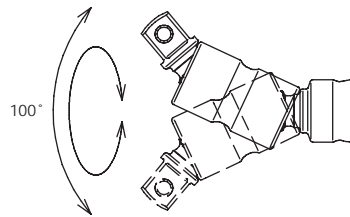

## 2756Z

Quick Spinner  
Rändel-Drehscheibe  
Lanceur



	D (mm)	L (mm)	(g)	(pcs.)
2756Z	20.3	18	15	10

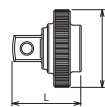

## 2756Z-3/8

## 2756Z-1/2

Quick Spinner, Adaptor  
Rändel-Drehscheibe als Adaptor  
Lanceur, adaptateur



2756Z-3/8

2756Z-1/2



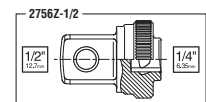
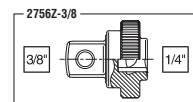
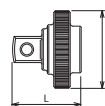





	D (mm)	L (mm)	(g)	(pcs.)
2756Z-3/8	20.3	21.5	24	10
2756Z-1/2	20.3	26	35	10



# 1/4"







Z-series  
Z-serie  
Series-Z

Z-SERIES  
HAND  
TITANIUM  
ACCESSORIES  
SCREWDRIVERS  
IMPACT  
SLEEVE-DRIVE  
PROTECTOR  
INDUSTRIAL  
AUTOMOTIVE  
MOTORCYCLE  
CONSTRUCTION  
SPARE PART

P2285Z		26 Pieces Set/△△=660g	
PLASTIC CASE:W245xH120xT45			
Sockets	Accessories		
 <b>2400MZ</b> 6-pt. Sockets 4, 4.5, 5, 5.5, 6, 7, 8, 10, 11,12, 13, 14		<b>2725Z</b>	
		<b>2756Z</b>	
 <b>2000Z.28</b> 1, 2, 3		<b>2771Z</b>	
 <b>2005Z.25</b> 5, 6		<b>2760Z-50</b>	
 <b>2010MZ.25</b> 3, 4, 5, 6		<b>2760Z-150</b>	



**P2285Z** Set in PE-foam tray  
Steckschlüsselsatz in Weichschaumeinlage  
Set disposé dans boîte de rangement en mousse souple

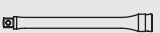

2286Z		17 Pieces Set/△△=780g	
BLACK METAL CASE:W240xH100xT32mm			
Sockets	Accessories		
 <b>2400MZ</b> 6-pt. Sockets 4, 5, 5.5, 6, 7, 8, 10, 11, 12, 13, 14		<b>2725Z</b>	
		<b>2756Z</b>	
		<b>2771Z</b>	
		<b>2760Z-50</b>	
		<b>2760Z-100</b>	
		<b>2760Z-150</b>	

**2286Z** Set in PE-foam tray  
Steckschlüsselsatz in Weichschaumeinlage  
Set disposé dans boîte de rangement en mousse souple



2285ZE		10 Pieces Set/△△=300g	
Rail 200mm/PLASTIC BAG			
Sockets	Accessories		
 <b>2400MZ</b> 6-pt. Sockets 5.5, 6, 7, 8, 10, 12, 13, 14		<b>2725Z</b>	
		<b>2756Z</b>	

**2285ZE** Socket Sets  
Steckschlüssel Sätze  
Jeu de clés à douilles



Z-SERIES  
HAND  
TITANIUM  
SCREWDRIVERS ACCESSORIES  
IMPACT  
SLEEVE-DRIVE  
PROTECTOR  
INDUSTRIAL  
AUTOMOTIVE  
MOTORCYCLE  
CONSTRUCTION  
SPARE PART

## 3400MZ

6-point Sockets  
6-kant Steckschlüssel  
Douilles 6-pans

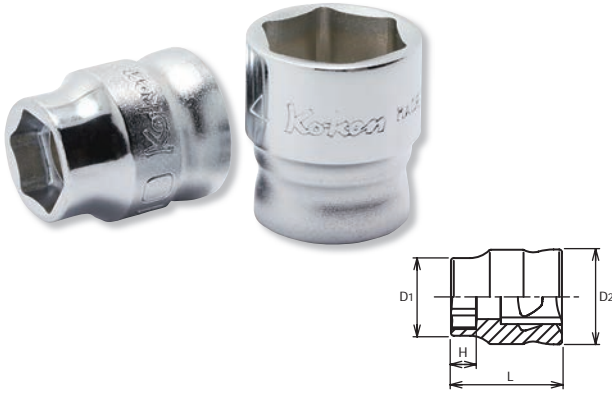

3400MZ (mm)	D <sub>1</sub> (mm)	D <sub>2</sub> (mm)	H (mm)	L (mm)	(g)	(pcs.)
5.5	8.5	17	3.5	19	16	10
6	9.1	17	3.5	19	17	10
7	10.3	17	3.5	19	17	10
8	11.5	17	4.5	20	17	10
10	14	17	4.5	20	18	10
11	15.3	17	5.5	21	18	10
12	16.5	17	5.5	21	19	10
13	17.8	17	8.5	21	19	10
14	19	17	8.5	21	20	10
15	20.2	18.2	8.5	21	24	10
16	21.3	19.3	8.5	21	28	10
17	22.5	20.5	8.5	21	32	10
18	23.6	21.6	9.5	22	38	10
19	24.8	22.8	9.5	22	41	10
21	27	25	10.5	23	51	10
22	28.3	26.3	10.5	23	58	10

3400MZ is designed 5-9mm shorter than standard 3400M.  
Ideal for working in confined and tight areas.

## RS3400MZ/8 RS3400MZ/12

Socket Set on magnetic Rail  
Steckschlüsselsatz auf Magnetschiene  
Jeu de douilles sur rail à aimant



RS3400MZ/8	8 Pieces Set/Rail 200mm	(g)
8, 10, 11, 12, 13, 14, 17, 19		320
RS3400MZ/12	12 Pieces Set/Rail 300mm	(g)
7, 8, 10, 11, 12, 13, 14, 15, 16, 17, 18, 19		490

## 3300XZ

6-point Sockets, Semi-Deep  
6-kant Steckschlüssel, mittel-lang  
Douilles, semi-profondes 6-pans

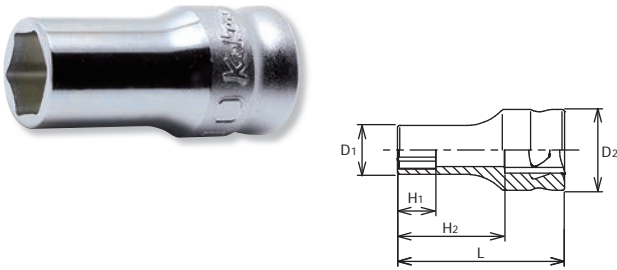

3300XZ (mm)	D <sub>1</sub> (mm)	D <sub>2</sub> (mm)	H <sub>1</sub> (mm)	H <sub>2</sub> (mm)	L (mm)	(g)	(pcs.)
7	10.3	17	8	23	35	23	10
8	11.5	17	9	23	35	24	10
10	14	17	11	23	35	26	10
11	15.3	17	12	23	35	28	10
12	16.5	17	13	23	35	29	10
13	17.8	17	14	23	35	32	10
14	19	17	16	23	35	34	10
15	20.2	18.2	16	23	35	40	10
16	21.3	19.3	16.5	23	35	45	10
17	22.5	20.5	16.5	23	35	50	10
18	23.6	21.6	16.5	23	35	56	10
19	24.8	22.8	18	23	35	60	10

## RS3300XZ/8 RS3300XZ/12

Socket Set on magnetic Rail  
Steckschlüsselsatz auf Magnetschiene  
Jeu de douilles sur rail à aimant



RS3300XZ/8	8 Pieces Set/Rail 200mm	(g)
8, 10, 11, 12, 13, 14, 17, 19		420
RS3300XZ/12	12 Pieces Set/Rail 300mm	(g)
7, 8, 10, 11, 12, 13, 14, 15, 16, 17, 18, 19		630

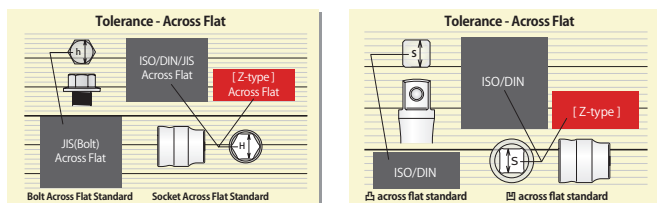

Manufacturing tolerance is precisely controlled to achieve a secure fitting.

## BALL HOLDING GROOVE

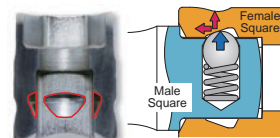

The inventive Ball Holding system of the Z-series allows a secure connection between Socket and Handle.

Die Werkzeuge der Z-Serie verfügen über spezielle Kugelfangrillen, die eine noch sicherere Verbindung zwischen Betätigungswerkzeug und Steckschlüssel gewährleisten.

La série Z dispose d'une rainure de fixation pour bille spéciale, qui améliore nettement la fixation entre douille et cliquet.

3300MZ (mm)	D <sub>1</sub> (mm)	D <sub>2</sub> (mm)	H <sub>1</sub> (mm)	H <sub>2</sub> (mm)	L (mm)	(g)	(pcs.)
7	10.3	17	8	41.5	55	29	10
8	11.5	17	9	41.5	55	34	10
10	14	17	11	41.5	55	43	10
11	15.3	17	12	41.5	55	45	10
12	16.5	17	13	41.5	55	49	10
13	17.8	17	14	41.5	55	52	10
14	19	17	16	41.5	55	55	10
15	20.2	18.2	16	40.5	55	65	10
16	21.3	19.3	17	40.5	55	74	10
17	22.5	20.5	18	40.5	55	83	10
18	23.6	21.6	19	39.5	55	90	10
19	24.8	22.8	20	39.5	55	95	10

RS3300MZ/8	8 Pieces Set/Rail 200mm	(g)
8, 10, 11, 12, 13, 14, 17, 19		600

RS3300MZ/12	12 Pieces Set/Rail 300mm	(g)
7, 8, 10, 11, 12, 13, 14, 15, 16, 17, 18, 19		900

RS3X00MZ/12	12 Pieces Set/Rail 300mm	(g)
3400MZ	8, 10, 11, 12, 13, 14, 17, 19	550
3300MZ	8, 10, 12, 14	

3300CZ (mm)	D (mm)	H (mm)	L (mm)	(g)	(pcs.)
14	18.4	11	70	67	10
16	20.5	13	70	71	10
18	22.9	12	70	75	10
20.8	26.3	13.5	70	105	10

Slim & light weight body with smaller outside diameter for work in tight spaces.

⚠ Spring clip type spark plug sockets caused deforming the clip if it would be used with shallow engagement.



3305PZ (mm)	D (mm)	H (mm)	L (mm)	(g)	(pcs.)
14	17.9	8	70	56	10
16	20	8	70	55	10

Spark Plug Socket with Magnet, 12-pt. opening: size 14mm



⚠ The magnet could be broken with any impacts. Please handle with care.

## 3300MZ

6-point Deep Sockets  
6-kant-Steckschlüssel, lang  
Douilles longues 6-pans

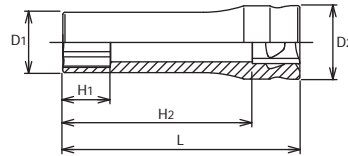

## RS3300MZ/8

Socket Set on magnetic Rail  
Steckschlüsselsatz auf Magnetschiene  
Jeu de douilles sur rail à aimant

## RS3300MZ/12



## RS3X00MZ/12

Socket Set on magnetic Rail  
Steckschlüsselsatz auf Magnetschiene  
Jeu de douilles sur rail à aimant



## 3300CZ

Spark Plug Sockets with Spring Clips  
Zündkerzen-Schlüssel mit Haltefeder  
Douilles avec ressorts de retenues pour bougies

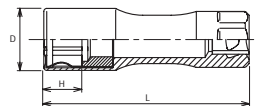

## 3305PZ

Spark Plug Socket with Magnet, 12-pt. opening  
Zündkerzensteckschlüssel mit Magnet, 12-kant  
Douille pour bougies, avec aimant, 12-pans

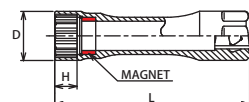

## 3010MZ-50 / -75

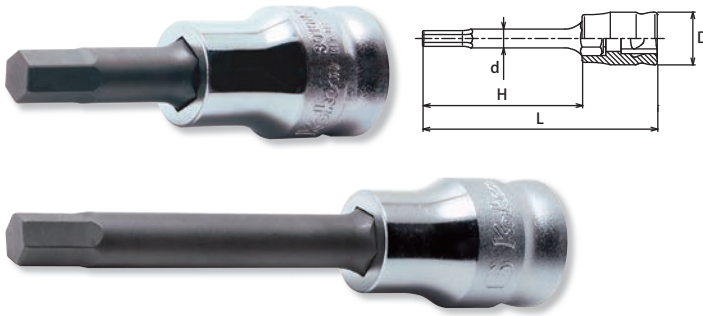

 Inhex Bit Sockets  
Steckschlüssel für Innensechskant-Schrauben  
Douilles tournevis pour vis 6-pans creux



3010MZ-50 (mm)	D (mm)	d (mm)	H (mm)	L (mm)	(g)	(pcs.)
3	17	4	23.5	50	28	10
4	17	5	23.5	50	29	10
5	17	6	23.5	50	30	10
6	17	7	23.5	50	35	10
7	17	-	23.5	50	38	10
8	17	-	23.5	50	40	10
10	17	-	23.5	50	50	10
12	19	-	23.5	50	70	10

3010MZ-75 (mm)	D (mm)	d (mm)	H (mm)	L (mm)	(g)	(pcs.)
3	17	6	48.5	75	33	10
4	17	6	48.5	75	35	10
5	17	6	48.5	75	36	10
6	17	7	48.5	75	41	10
7	17	7.9	48.5	75	45	10
8	17	-	48.5	75	48	10
10	17	-	48.5	75	65	10
12	19	-	48.5	75	90	10

## RS3010MZ/8-L50 RS3010MZ/8-L75

  Socket Set on magnetic Rail  
Steckschlüsselsatz auf Magnetschiene  
Jeu de douilles sur rail à aimant



RS3010MZ/8-L50	8 Pieces Set/Rail 200mm	(g)
3, 4, 5, 6, 7, 8, 10, 12		460

RS3010MZ/8-L75	8 Pieces Set/Rail 200mm	(g)
3, 4, 5, 6, 7, 8, 10, 12		530

## 3025Z-50 / -75

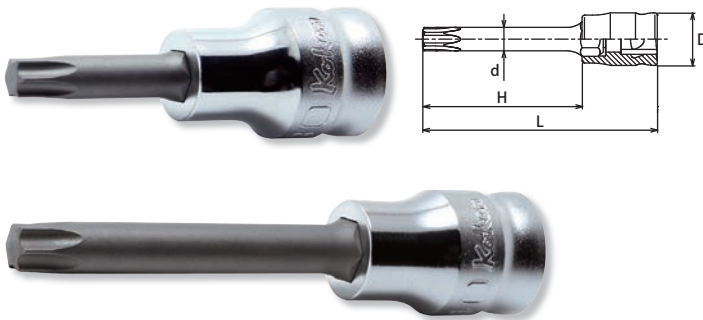

 TORX® Bit Sockets  
TORX® Bit-Steckschlüssel  
Douilles tournevis, TORX®



3025Z-50 (T)	D (mm)	d (mm)	H (mm)	L (mm)	(g)	(pcs.)
T10	17	3	23.5	50	27	10
T15	17	3.5	23.5	50	28	10
T20	17	3.9	23.5	50	28	10
T25	17	4.5	23.5	50	29	10
T27	17	5	23.5	50	30	10
T30	17	5.6	23.5	50	31	10
T40	17	6.7	23.5	50	35	10
T45	17	7.83	23.5	50	38	10
T50	17	8.90	23.5	50	48	10
T55	19	11.3	23.5	50	70	10

3025Z-75 (T)	D (mm)	d (mm)	H (mm)	L (mm)	(g)	(pcs.)
T20	17	4.5	48.5	75	32	10
T25	17	5	48.5	75	33	10
T27	17	5	48.5	75	33	10
T30	17	5.6	48.5	75	35	10
T40	17	6.7	48.5	75	41	10
T45	17	7.9	48.5	75	45	10
T50	17	8.9	48.5	75	55	10
T55	19	11.3	48.5	75	80	10

## RS3025Z/8-L50 RS3025Z/8-L75

  Socket Set on magnetic Rail  
Steckschlüsselsatz auf Magnetschiene  
Jeu de douilles sur rail à aimant



RS3025Z/8-L50	8 Pieces Set/Rail 200mm	(g)
T20, T25, T27, T30, T40, T45, T50, T55		450

RS3025Z/8-L75	8 Pieces Set/Rail 200mm	(g)
T20, T25, T27, T30, T40, T45, T50, T55		480



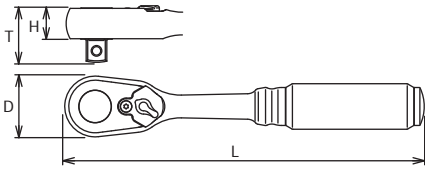

36

## 2725Z-3/8 2725Z-3/8 (L160)

Reversible Ratchet Short  
Knarre kurz, verstellbar  
Cliquet court, réversible



	D (mm)	T (mm)	H (mm)	L (mm)	(g)	(pcs.)
2725Z-3/8	20.5	20.5	9.5	114	83	2
New 2725Z-3/8 (L160)	20.5	20.5	9.5	160	120	2

\* Renewal Kits → 2725RK-3/8 → P305

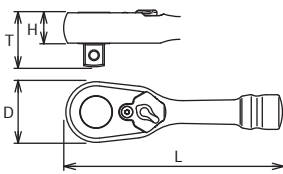

36

## 3725ZS

Reversible Ratchet Short  
Knarre kurz, verstellbar  
Cliquet court, réversible



	D (mm)	T (mm)	H (mm)	L (mm)	(g)	(pcs.)
3725ZS	28	24.5	13.7	100	157	2

\* Renewal Kits → 3725RK → P305

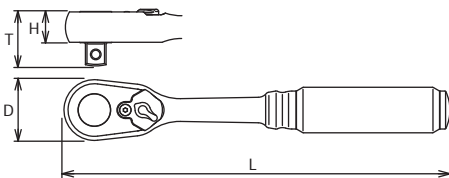

36

## 3725Z 3725Z-280

Reversible Ratchet  
Knarre, verstellbar  
Cliquet, réversible



	D (mm)	T (mm)	H (mm)	L (mm)	(g)	(pce.)
3725Z	28	24.5	13.7	178	254	1
3725Z-280	28	24.5	13.7	280	360	1

\* Renewal Kits → 3725RK → P305

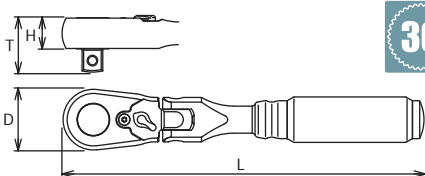

36  Flexible Head

## 2726Z-3/8 2726Z-3/8 (L160)

Flexible Ratchet, Reversible (Short)  
Gelenk-Knarre kurz, verstellbar  
Cliquet articulé court, réversible



	D (mm)	T (mm)	H (mm)	L (mm)	(g)	(pcs.)
2726Z-3/8	20.5	20.5	9.5	114	107	2
New 2726Z-3/8 (L160)	20.5	20.5	9.5	160	130	2

\* Renewal Kits → 2725RK-3/8 → P305

## 3726ZS

Flexible Ratchet, Reversible (Short)  
Gelenk-Knarre kurz, verstellbar  
Cliquet articulé court, réversible

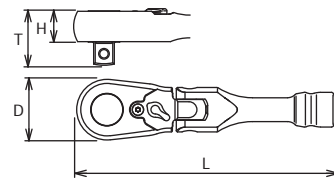

	D (mm)	T (mm)	H (mm)	L (mm)	(g)	(pcs.)
3726ZS	28	24.5	13.7	120	196	2

\* Renewal Kits → 3725RK → P305

## 3726Z 3726Z-280

Flexible Ratchet, Reversible  
Gelenk-Knarre, verstellbar  
Cliquet articulé, réversible

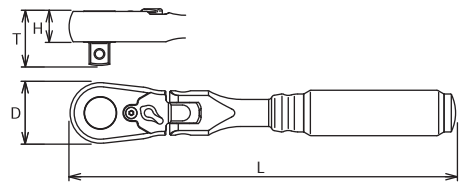

	D (mm)	T (mm)	H (mm)	L (mm)	(g)	(pcs.)
3726Z	28	24.5	13.7	178	317	1
3726Z-280	28	24.5	13.7	280	420	1

\* Renewal Kits → 3725RK → P305

## 3768Z-250 3768Z-400

Hinge Handle  
Gelenkgriff  
Poignée articulée

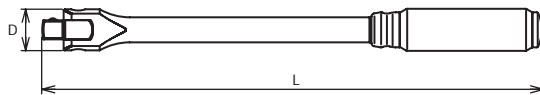

	D (mm)	L (mm)	(g)	(pcs.)
3768Z-250	20.5	250	309	5
3768Z-400	20.5	400	500	2

\* Renewal Kits → 3768ZRK → P306

## 3760Z

Extension Bars  
Verlängerungen  
Rallonges

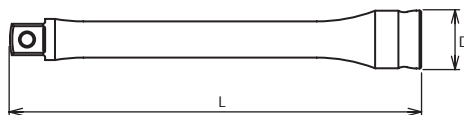

	D (mm)	L (mm)	(g)	(pcs.)
3760Z-75	17.5	75	66	10
3760Z-125	17.5	125	103	10
3760Z-250	17.5	250	195	5

	D (mm)	L (mm)	(g)	(pcs.)
<b>3771Z</b>	18	42.5	44	10



**3771Z** Universal Joint  
Gelenk-Einsatz  
Joint articulé

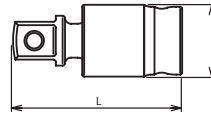
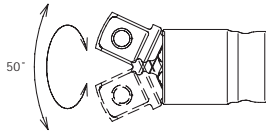

	D (mm)	L (mm)	(g)	(pcs.)
<b>3772Z</b>	17	65	76	10

**3772Z** Universal Double Joint  
Doppelgelenk-Einsatz  
Joint articulé double

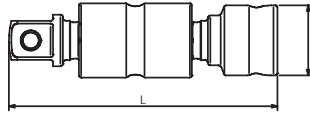
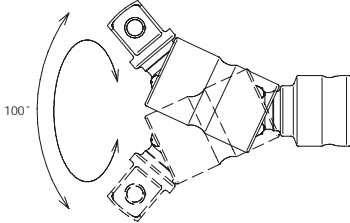

	D (mm)	L (mm)	(g)	(pcs.)
<b>3756Z</b>	28	25	40	10

Outside diameter is smaller compared to standard 3756.  
Ideal for working in combination with 3725Z



**3756Z** Quick Spinner  
Rändel-Drehscheibe  
Lanceur

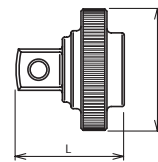

	D (mm)	L (mm)	(g)	(pcs.)
<b>3756ZS</b>	20.3	25	26	10

Ideal for working in combination with 2725Z-3/8 and 2726Z-3/8.

**3756ZS** Quick Spinner  
Rändel-Drehscheibe  
Lanceur

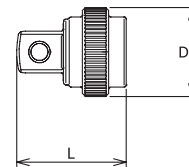

	D (mm)	L (mm)	(g)	(pcs.)
<b>3756Z-1/2</b>	28	29	52	10

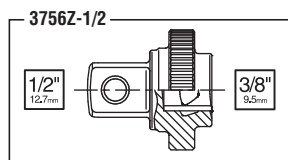

**3756Z-1/2** Quick Spinner, Adaptor  
Rändel-Drehscheibe als Adaptor  
Lanceur, adaptateur

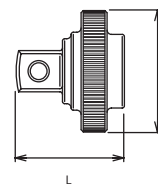

	D (mm)	L (mm)	(g)	(pcs.)
<b>3322AZ-75</b>	17.5	75	42	10

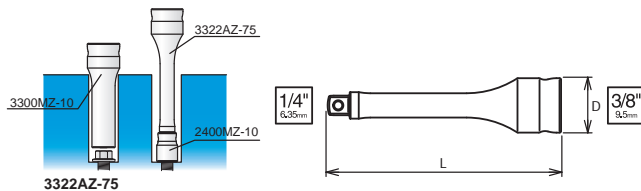

**3322AZ-75** Extension Adaptor  
Verlängerungsadapter  
Reduction adaptateur-rallonge



Z-series  
Z-serie  
Series-Z

# 3/8"

Z-SERIES

HAND

TITANIUM

ACCESSORIES

SCREWDRIVERS

IMPACT

SLEEVE-DRIVE

PROTECTOR

INDUSTRIAL

AUTOMOTIVE

MOTORCYCLE

CONSTRUCTION

SPARE PART

**3285Z** Set in PE-foam tray  
Steckschlüsselsatz in Weichschaumeinlage  
Set disposé dans boîte de rangement en mousse souple



**3285ZA** Set in PE-foam tray  
Steckschlüsselsatz in Weichschaumeinlage  
Set disposé dans boîte de rangement en mousse souple



**3286Z** Set in PE-foam tray  
Steckschlüsselsatz in Weichschaumeinlage  
Set disposé dans boîte de rangement en mousse souple



**3285ZE** Socket Sets  
Steckschlüssel Sätze  
Jeu de clés à douilles



**RSAL200**  Magnetic Rail with retaining clips  
Magnetschiene mit Halteklammern  
**RSAL300** Rail à aimant avec clips de maintien













**RSAL** Magnetic Rails and retaining Clips, bulk  
Magnetschiene und Halteklammern, lose  
**CLIP.P/5** Rail à aimant avec clips de maintien, en vrac



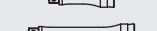

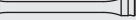

**3285Z** 26 Pieces Set/△=2,100g

PLASTIC TRAY:W390xT180xH25

Sockets	Accessories
 <b>3400MZ</b> 6-pt. Sockets 5.5, 6, 7, 8, 10, 12, 13, 14, 17, 19, 21, 22	 <b>3725Z</b>
 <b>3300MZ</b> 6-pt. Deep Sockets 8, 10, 12, 14	 <b>3756Z</b>
 <b>3300CZ</b> Spark Plug Sockets 14, 16, 20.8	 <b>3771Z</b>
	 <b>3768Z-250</b>
	 <b>3760Z-75</b>
	 <b>3760Z-125</b>
	 <b>3760Z-250</b>







**3285ZA** 15 Pieces Set/△=750g

PLASTIC TRAY:W300xT90xH25

Sockets	Accessories
 <b>3400MZ</b> 6-pt. Sockets 5.5, 6, 7, 8, 10, 12, 13, 14, 17, 19, 21, 22	 <b>3725Z</b>
	 <b>3756Z</b>
	 <b>3771Z</b>



**3286Z** 21 Pieces Set/△=2,600g

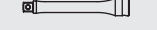

BLACK METAL CASE:W415xH120xT50mm



Sockets	Accessories
 <b>3400MZ</b> 6-pt. Sockets 7, 8, 10, 11, 12, 13, 14, 15, 16, 17, 18, 19, 21, 22	 <b>3725Z</b>
	 <b>3756Z</b>
	 <b>3771Z</b>
	 <b>3768Z-250</b>
	 <b>3760Z-75</b>
	 <b>3760Z-125</b>
	 <b>3760Z-250</b>

**3285ZE** 9 Pieces Set/△=600g

Rail 200mm/PLASTIC BAG

Sockets	Accessories
 <b>3400MZ</b> 6-pt. Sockets 8, 10, 12, 13, 14, 17, 19	 <b>3725Z</b>
	 <b>3756Z</b>

RSAL200		RAIL (mm)	CLIP (pcs.)	(g)	(pce.)
1/4x12		200	12	125	1
3/8x8		200	8	130	1





RSAL300		RAIL (mm)	CLIP (pcs.)	(g)	(pce.)
3/8x12		300	12	180	1
1/2x10		300	10	190	1



**RAIL**

	RAIL (mm)	(g)	(pce.)
<b>RSAL200</b>	200	110	1
<b>RSAL300</b>	300	145	1
<b>RSAL400</b>	400	210	1

**CLIP**

CLIP.P/5		(g)	(pcs.)
1/4		10	5
3/8		13	5
1/2		20	5

# 1/2"

Z-series  
Z-serie  
Series-Z

4400MZ (mm)	D <sub>1</sub> (mm)	D <sub>2</sub> (mm)	H (mm)	L (mm)	(g)	(pcs.)
8	12.6	20.6	4.5	26	30	10
10	15	20.6	4.5	26	31	10
12	17	20.6	5.5	27	32	10
13	18.3	21.5	6.5	28	40	10
14	19.5	21.5	6.5	28	40	10
16	22	21.5	7.5	29	43	10
17	23	22.5	7.5	29	49	10
18	24.1	23.7	7.5	29	56	10
19	25.3	24.4	9.5	29	62	10
21	27.6	26.3	10.5	29	76	10
22	28.8	27.5	11	29	83	10
24	31.1	29.2	12	29	96	5
27	34.6	32.2	13.5	30	124	5
30	38.1	35.2	14.5	31	156	5
32	40.4	36.8	15.5	32	178	5

## 4400MZ



6-point Sockets  
6-kant Steckschlüssel  
Douilles 6-pans

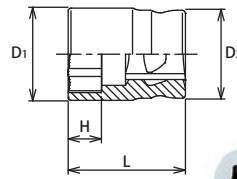

RS4400MZ/10	10 Pieces Set/Rail 300mm	(g)
10, 12, 13, 14, 17, 19, 21, 22, 24, 27		830

## RS4400MZ/10



Socket Set on magnetic Rail  
Steckschlüsselsatz auf Magnetschiene  
Jeu de douilles sur rail à aimant



36

## 4725Z

Reversible Ratchet  
Knarre, verstellbar  
Cliquet, réversible



	D (mm)	T (mm)	H (mm)	L (mm)	(g)	(pce.)
4725Z	36.5	32.8	18.2	253	590	1

\* Renewal Kits → 4725RK → P305

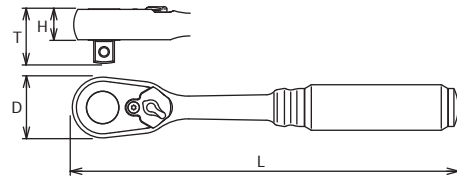

RENEWAL KIT FOR HINGE HANDLE



OVAL SHAPE SHANK



OVAL SHANK

## 4768Z-430

Hinge Handle  
Gelenkgriff  
Poignée articulée



	D (mm)	L (mm)	(g)	(pce.)
4768Z-430	28	430	720	1

\* Renewal Kits → 4768ZRK → P306

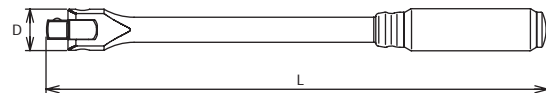

## 4760Z

Extension Bars  
Verlängerungen  
Rallonges



	D (mm)	L (mm)	(g)	(pcs.)
4760Z-125	22.5	125	180	5
4760Z-250	22.5	250	340	5

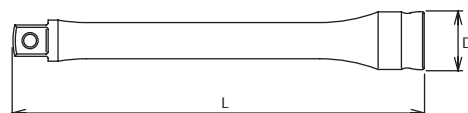

**4771Z** Universal Joint  
Gelenk-Einsatz  
Joint articulé

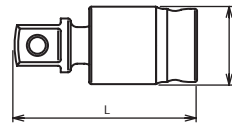

	D (mm)	L (mm)	⚖️ (g)	📦 (pcs.)
<b>4771Z</b>	23.7	55.8	100	10

**4772Z** Universal Double Joint  
Doppelgelenk-Einsatz  
Joint articulé double

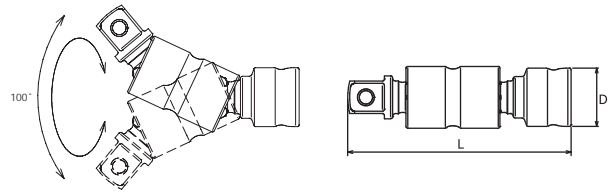

	D (mm)	L (mm)	⚖️ (g)	📦 (pcs.)
<b>4772Z</b>	23.7	87.2	170	5

**4756Z** Quick Spinner  
Rändel-Drehscheibe  
Lanceur

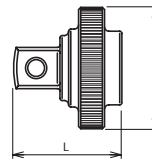

	D (mm)	L (mm)	⚖️ (g)	📦 (pcs.)
<b>4756Z</b>	36.3	33.5	84	10

**4285Z** Set in Foam tray  
Steckschlüsselsatz in Weichschaumeinlage  
Set disposé dans boîte de rangement en mousse souple

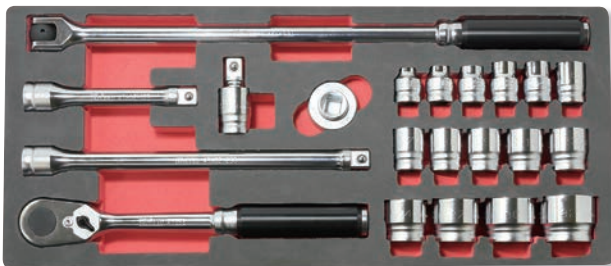

<b>4285Z</b>		21 Pieces Set/⚖️=4,800g
METAL CASE:W445xT190xH50		
Sockets	Accessories	
<b>4400MZ</b> 6-pt. Sockets 8, 10, 12, 13, 14, 16, 17, 18, 19, 21, 22, 24, 27, 30, 32	<b>4725Z</b> <b>4756Z</b> <b>4771Z</b> <b>4768Z-430</b> <b>4760Z-125</b> <b>4760Z-250</b>	

**4285ZE** Socket Sets  
Steckschlüssel Sätze  
Jeu de clés à douilles



<b>4285ZE</b>		11 Pieces Set/⚖️=1,380g
Rail 300mm/PLASTIC BAG		
Sockets	Accessories	
<b>4400MZ</b> 6-pt. Sockets 10, 12, 13, 14, 17, 19, 21,22, 24	<b>4725Z</b> <b>4756Z</b>	

# HAND

SOCKETS  
STECKSCHLÜSSEL  
DOUILLES À MAIN

1/4"

3/8"















































1/2"

3/4"









1"

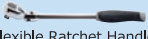
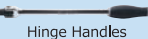

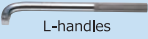
Hand Sockets  
Hand Steckschlüssel  
Douilles à main

Hand Sockets		Square Drive									
		1/4"(6.35mm)SQ.		3/8"(9.5mm)SQ.		1/2"(12.7mm)SQ.		3/4"(19mm)SQ.		1"(25.4mm)SQ.	
		No.	Page	No.	Page	No.	Page	No.	Page	No.	Page
	 6-point	2400M mm 40 2400A inch 40 2400W BA 41	3400M mm 58 3400A inch 58 3400W BSW 59	4401M / 4400M mm 92 4400A inch 93 4400W BSW 94	6400M mm 120 6400A inch 120	8400M mm 126 8400A inch 126					
	 12-point	2405M mm 40 2405A inch 40 AS2405A inch 40	3405M mm 58 3405A inch 58 3405W BSW 59	4406M / 4405M mm 92 4405A inch 93 4405W BSW 94	6405M mm 120 6405A inch 120	8405M mm 126 8405A inch 126					
	 Surface	2410M mm 41	3410M mm 59	4410M mm 94							
	 NUT GRIP®	2450MS mm 42	3450M mm 61 3450MH mm 61	4450M mm 96							
	 TORX® (E)	2425 TORX® 42	3425 TORX® 60	4425 TORX® 95 4425-N TORX® 94	6425 TORX® 120						
	 TORX® (E) (NUT GRIP®)		3425(2B) TORX® 61								
	 TORXplus® (EP)			4425-EPL TORXplus® 95							
	 LH-S		3400LH LH-STIX® 60	4400LH LH-STIX® 96							
	 6-point	2300X mm 42	3300X mm 62 3300XA inch 62								
	 12-point		3305X mm 62 3305XA inch 62								
	 NUT GRIP®	2350X mm 42	3350X mm 62								
	 6-point	2300M mm 43 2300A inch 43 2300W BA 44	3300M mm 63 3300A inch 63 3300W BSW 64	4300M mm 97 4300A inch 97	6300M mm 121 6300A inch 121						
	 12-point	2305M mm 43 2305A inch 43 AS2305A inch 43	3305M mm 63 3305A inch 63 3305W BSW 64	4305M mm 97 4305A inch 97	6305M mm 121 6305A inch 121						
	 Surface	2310M mm 44	3310M mm 64	4310M mm 98							
	 NUT GRIP®	2350M mm 44	3350M mm 65								
	 TORX® (E)	2325 TORX® 44	3325 TORX® 65	4325 TORX® 98							
	 Flare Nut		3300FN mm 65								
	 6-point		3300M(L120) mm 66	4300M(L120) mm 99							
	 12-point		3305M(L120) mm 66								
	 NUT GRIP®		3350M(L120) mm 66								
	 TORX® (E)			4325(L140) TORX® 99							
	 TORX® (E) (NUT GRIP®)			4325(L140)-2B TORX® 99							
	 12-point		3117M mm 69	4117M mm 99							
	 6-point	2440M mm 45 2440A inch 45	3440M mm 67 3440A inch 67	4440M mm 100 4440A inch 100							
	 12-point	2445M mm 45 2445A inch 45 AS2445A inch 45	3445M mm 67 3445A inch 67 3445W BSW 67	4445M mm 100 4445A inch 100							
	 NUT GRIP®	2441M mm 45	3441M mm 68								
	 TORX® (E)	2440T TORX® 45	3440T TORX® 68	4440T TORX® 100							
	 6-point		3340M mm 68								
	 PH	2000 PH 46	3000 PH 70	4000 PH 100							
	 PZ	2000(PZ) PZ 46	3000(PZ) PZ 70	4000(PZ) PZ 100							
	 Slotted	2005 Slotted 46	3005 Slotted 70	4005 Slotted 100							
	 Hexagon	2010M mm 47 2010A inch 47	3010M mm 71 3010A inch 71 3012M mm 72 3012A inch 72	4010M mm 101 4010A inch 101 4012M mm 102 4012A inch 103	6012M mm 121	8012M mm 127					
	 Hexagon (Grip Ring)		3015M mm 73								
	 Hexagon (Ball Point)	2011M mm 47	3011M mm 73								
	 XZN (Triple Square)	2020 XZN 47	3020 XZN 74	4020 XZN 104							
	TORX® (T)	2025(T) TORX® 48	3025(T) TORX® 75	4025(T) TORX® 105							
	TORX® (TH)	2025(TH) TORX® 48	3025(TH) TORX® 76								
	TORXplus® (IP)	2025(IP) TORXplus® 49	3025(IP) TORXplus® 77	4025(IP) TORXplus® 106							
	TORXplus® (IPR)	2025(IPR) TORXplus® 49	3025(IPR) TORXplus® 78								
	Ribe CV		3027 Ribe CV 78	4027 Ribe CV 107							
		 Hexagon	2430M mm 46	3430M mm 69							
 TORX® (T)		2430T TORX® 46									



Handles/Accessories		Square Drive									
		1/4"(6.35mm)SQ.		3/8"(9.5mm)SQ.		1/2"(12.7mm)SQ.		3/4"(19mm)SQ.		1"(25.4mm)SQ.	
		No.	Page	No.	Page	No.	Page	No.	Page	No.	Page
 Ratchet Handles	Standard	2753 series	50	3753 series 3752 series	81-82 81	4753 series 4750 series 4752 series	110 109 108	6749 6752	122 122	8749	128
	Short	2753PS series	50	3749S series	80						
	Long	2753P-160	50	3753P-250	81	4749-380 series 4753P-410	111 111	6749-1000	122	8749-1000	128
	Compact			2749-3/8 series	80	3749S-1/2 series	108				
	Others			3753SM series 3757	80 85						
 Flexible Ratchet Handles	Standard	2774 series	51	3774 series	83-84	4774 series	111-112				
	Short	2774PS 2774JS	51 51	3774PS	82						
	Long					4774P-450	111				
	Compact			2774-3/8 series	82						
	Swivel Head			3776 series	84						
	Speeder			3774P-SR	84						
 Hinge Handles	Standard	2768 series	53	3768-250 series	87	4768-380 series	112	6768	123	8768	128
	Long					4768-450 series	112	6768-600	123	8768-1000	128
	Extra Long			3768P-380	87			6768-1000	123		
 T-type Slide Handles	Standard	2785 series	54	3785	88	4785	114	6785	124	8785	128
	Long									8785-700	128
 Spin Type Handles	Standard	2769N	53	3769N	87						
	Wobble-Fix	2769NWF	53	3769NWF	87						
	Others	2769H	53	3769H	87						
 L-handles						4788 4747	115 115	6788	124	8788	128
 Speed Handles	Standard	2780	54	3780	88	4780-400	114				
	Flexible					4781N-450	114				
 Extension Bars	Standard	2760	52	3760	86	4760	113	6760	123	8760	127
	Wobble-Fix	2763	52	3763	86	4763	113				
	Flexible	2762	52	3762	85						
 Universal Joints		2770 2771	54 54	3770 3771	88 88	4770 4771	114 114	6770	124	8770	127
 Adaptors		2233A	54	3322A 3344A	88 88	4433A 4466A	115 115	6644A 6688A	124 124	8866A	127
 Ratchet Adaptors		2755	51	3755	85	4755	112	6755	123		
 Quick Spinners		2756	51	3756	85	4756	112				

Z-SERIES  
HAND  
TITANIUM  
ACCESSORIES  
SCREWDRIVERS  
IMPACT  
SLEEVE-DRIVE  
PROTECTOR  
INDUSTRIAL  
AUTOMOTIVE  
MOTORCYCLE  
CONSTRUCTION  
SPARE PART

Hand Sockets  
Hand Steckschlüssel  
Douilles à main

# 1/4"

Z-SERIES

HAND

TITANIUM

SCREWDRIVERS ACCESSORIES

IMPACT

SLEEVE-DRIVE

PROTECTOR

INDUSTRIAL

AUTOMOTIVE

MOTORCYCLE

CONSTRUCTION

SPARE PART

## 2400M / 2400A

6-point Sockets  
6-kant Steckschlüssel  
Douilles 6-pans

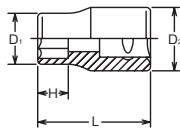

2400M 2405M (mm)	D <sub>1</sub> (mm)	D <sub>2</sub> (mm)	H (mm)	L (mm)	(g)	(pcs.)
3	5.5	11.2	2.6	22	7	10
3.5	6.1	11.2	3	22	7	10
4	6.7	11.2	3.5	22	8	10
4.5	7.3	11.2	4	22	8	10
5	8	11.2	5	22	8	10
5.5	8.5	11.2	5.5	22	9	10
6	9.2	11.2	5.5	22	9	10
7	10.3	11.2	6	22	9	10
8	11.2	11.7	6.9	22	11	10
9	13	12	7.3	22	12	10
10	14.3	12.9	7.7	22	15	10
11	15.5	14.3	9.3	22	18	10
12	16.8	15.5	9.3	22	23	10
13	18	16.4	9.8	22	23	10
14	19.3	17.9	11	24	30	10

## 2405M / 2405A

12-point Sockets  
12-kant Steckschlüssel  
Douilles 12-pans

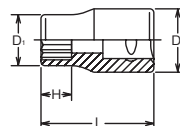

2400A 2405A (inch)	D <sub>1</sub> (mm)	D <sub>2</sub> (mm)	H (mm)	L (mm)	(g)	(pcs.)
1/8	5.7	11.2	2.7	22	7	10
5/32	6.7	11.2	3.5	22	8	10
3/16	7.8	11.2	5	22	8	10
7/32	8.5	11.2	5.5	22	9	10
1/4	9.6	11.2	5.8	22	9	10
9/32	10.3	11.2	6	22	9	10
5/16	11.2	11.7	6.9	22	11	10
11/32	12.5	11.7	7.3	22	12	10
3/8	13.7	12.5	7.7	22	15	10
7/16	15.5	14.3	9.3	22	18	10
1/2	18	16.4	9.8	22	23	10
9/16	19.3	17.9	11	24	30	10

## RS2400M/12

Socket Set on Rail  
Steckschlüsselsatz auf Schiene  
Jeu de douilles sur rail



RS2400M/12	12 Pieces Set/Rail 200mm	(g)
<b>4, 5, 5.5, 6, 7, 8, 9, 10, 11, 12, 13, 14</b>		200

RS2405M/12	12 Pieces Set/Rail 200mm	(g)
<b>4, 5, 5.5, 6, 7, 8, 9, 10, 11, 12, 13, 14</b>		200

## RS2400A/9

Socket Set on Rail  
Steckschlüsselsatz auf Schiene  
Jeu de douilles sur rail



RS2400A/9	9 Pieces Set/Rail 150mm	(g)
<b>3/16, 7/32, 1/4, 9/32, 5/16, 11/32, 3/8, 7/16, 1/2</b>		162

RS2405A/9	9 Pieces Set/Rail 150mm	(g)
<b>3/16, 7/32, 1/4, 9/32, 5/16, 11/32, 3/8, 7/16, 1/2</b>		162

## AS2405A

12-point Sockets, AS954  
12-kant Steckschlüssel, AS954  
Douilles 12-pans, AS954

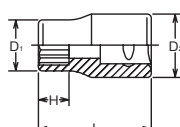

AS2405A (inch)	D <sub>1</sub> (mm)	D <sub>2</sub> (mm)	H (mm)	L (mm)	(g)	(pcs.)
3/16	7.7	10.9	5.1	22	8	10
7/32	8.5	10.9	5.5	22	8	10
1/4	9.4	10.9	5.9	22	8	10
9/32	10.2	10.9	6.1	22	8	10
5/16	11.3	11.7	7.3	22	10	10
11/32	12.5	12	7.5	22	10	10
3/8	13.7	12.9	8.2	22	13	10
7/16	15.6	14.3	9.4	22	17	10
1/2	17.2	16.4	10.3	22	20	10
9/16	18.8	17.9	11	24	27	10

Aerospace Standard SAE AS954

## RSAS2405A/10

Socket Set on Rail  
Steckschlüsselsatz auf Schiene  
Jeu de douilles sur rail



RSAS2405A/10	10 Pieces Set/Rail 150mm	(g)
<b>3/16, 7/32, 1/4, 9/32, 5/16, 11/32, 3/8, 7/16, 1/2, 9/16</b>		160

# 1/4" Hand Sockets Hand Steckschlüssel Douilles à main

2410M (mm)	D <sub>1</sub> (mm)	D <sub>2</sub> (mm)	H (mm)	L (mm)	(g)	(pcs.)
4	6.7	11.2	3.5	22	8	10
4.5	7.3	11.2	4	22	8	10
5	8	11.2	5	22	8	10
5.5	8.5	11.2	5.5	22	9	10
6	9.2	11.2	5.5	22	9	10
7	10.3	11.2	6	22	9	10
8	11.2	11.7	6.9	22	11	10
9	13	12	7.3	22	12	10
10	14.3	12.9	7.7	22	15	10
11	15.5	14.3	9.3	22	18	10
12	16.8	15.5	9.3	22	23	10
13	18	16.4	9.8	22	23	10
14	19.3	17.9	11	24	30	10



**2410M** Surface Drive Sockets  
Surface Drive Steckschlüssel  
Douilles, Surface Drive

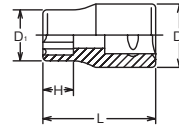

RS2410M/12	12 Pieces Set/Rail 200mm	(g)
4, 5, 5.5, 6, 7, 8, 9, 10, 11, 12, 13, 14		222

**RS2410M/12** Socket Set on Rail  
Steckschlüsselsatz auf Schiene  
Jeu de douilles sur rail



2400W (BA)	D <sub>1</sub> (mm)	D <sub>2</sub> (mm)	H (mm)	L (mm)	(g)	(pcs.)
8	6.1	11.2	3	22	7	10
7	7.3	11.2	4	22	8	10
6	8	11.2	5	22	8	10
5	8.5	11.2	5.5	22	9	10
4	9.6	11.2	5.8	22	9	10
3	10.3	11.2	6	22	9	10
2	11.2	11.7	6.9	22	11	10
1	13	12	7.3	22	12	10
0	14.9	13.6	8	22	16	10

**2400W-BA** 6-point Sockets  
6-kant Steckschlüssel  
Douilles 6-pans

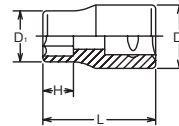

RS2400W/9-BA	9 Pieces Set/Rail 150mm	(g)
8, 7, 6, 5, 4, 3, 2, 1, 0		120

**RS2400W/9-BA** Socket Set on Rail  
Steckschlüsselsatz auf Schiene  
Jeu de douilles sur rail



BA	Across Flat										
	BA	8BA	7BA	6BA	5BA	4BA	3BA	2BA	1BA	0BA	
	(ref. mm)	3.86	4.37	4.90	5.59	6.30	7.16	8.23	9.27	10.49	
S	(ref. inch)	0.152	0.172	0.193	0.220	0.248	0.282	0.324	0.365	0.413	

2415M (mm)	D <sub>1</sub> (mm)	D <sub>2</sub> (mm)	H (mm)	L (mm)	(g)	(pcs.)
5.5	10.3	11.2	5.4	22	10	10
6	11	11.7	5.4	22	13	10
7	12.5	11.7	6.1	22	13	10
8	14.3	12.9	6.8	22	17	10
10	17.4	16	8.2	22	27	10

2415A (inch)	D <sub>1</sub> (mm)	D <sub>2</sub> (mm)	H (mm)	L (mm)	(g)	(pcs.)
1/4	11	11.7	5.4	22	14	10
5/16	14.3	12.9	6.8	22	17	10
3/8	17.4	16	8.2	22	26	10

**2415M / 2415A** Double 4-point Sockets  
Doppelvierkant Steckschlüssel  
Douilles mâles 4-pans doubles

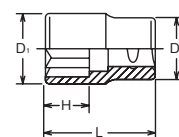

# Hand Sockets Hand Steckschlüssel Douilles à main

# 1/4"

Z-SERIES  
HAND  
TITANIUM  
SCREWDRIVERS  
ACCESSORIES  
IMPACT  
SLEEVE-DRIVE  
PROTECTOR  
INDUSTRIAL  
AUTOMOTIVE  
MOTORCYCLE  
CONSTRUCTION  
SPARE PART

## 2425 TORX® Sockets TORX® Steckschlüssel Douilles TORX®

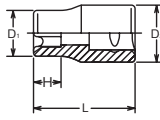

2425 (E)	D <sub>1</sub> (mm)	D <sub>2</sub> (mm)	H (mm)	L (mm)	(g)	(pcs.)
E 4	5.4	11.2	4.6	22	7	10
E 5	6.7	11.2	5.2	22	8	10
E 6	7.7	11.2	5.4	22	8	10
E 7	8.3	11.2	6.6	22	9	10
E 8	9.6	11.2	7	22	9	10
E10	11.3	12	8.2	22	10	10
E11	12.9	12	8.7	22	13	10
E12	14.3	12.9	9.3	23	17	10

## RS2425/6 Socket Set on Rail Steckschlüsselsatz auf Schiene Jeu de douilles sur rail

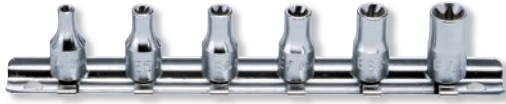

RS2425/6	6 Pieces Set/Rail 150mm	(g)
E4, E5, E6, E7, E8, E10		85

### TORX® (E)

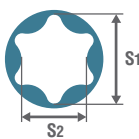

E	E4	E5	E6	E7	E8	E10	E11	E12	E14	E16	E18	E20	E22	E24	E26	E28	E30	E32
S <sub>1</sub> (ref. mm)	3.7	4.6	5.6	6.1	7.4	9.3	9.9	11.0	12.8	14.6	16.5	18.3	20.1	22.0	23.7	25.5	27.3	29.0
S <sub>2</sub> (ref. mm)	2.7	3.3	4.0	4.3	5.3	6.8	7.1	7.9	9.2	10.5	11.9	13.2	14.8	15.7	17.5	18.3	20.0	21.3

## 2450MS Nut Grip Sockets Nut Grip® Steckschlüssel mit 2-facher Kugelhalterung Douilles à billes de retenue

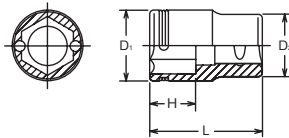

2450MS (mm)	D <sub>1</sub> (mm)	D <sub>2</sub> (mm)	H (mm)	L (mm)	(g)	(pcs.)
7	11.3	11.2	4	18	8	10
8	12.3	11.2	5	18	9	10
10	14.3	12.9	6	19	13	10
12	17.4	16	7	20	22	10
13	18	16.4	8	20	22	10
14	19.9	18	8.5	22	31	10

## RS2450MS/6 Socket Set on Rail Steckschlüsselsatz auf Schiene Jeu de douilles sur rail



RS2450MS/6	6 Pieces Set/Rail 150mm	(g)
7, 8, 10, 12, 13, 14		120

## 2300X 6-point Sockets, Semi-Deep 6-kant Steckschlüssel, mittel-lang Douilles, semi-profondes 6-pans

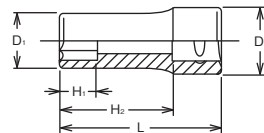

2300X (mm)	D <sub>1</sub> (mm)	D <sub>2</sub> (mm)	H <sub>1</sub> (mm)	H <sub>2</sub> (mm)	L (mm)	(g)	(pcs.)
4	6.7	11.2	4	22	32	10	10
5	8	11.2	5.5	22	32	11	10
5.5	8.5	11.2	6	22	32	12	10
6	9.2	11.2	7	22	32	12	10
7	10.5	11.2	8	22	32	13	10
8	11.8	11.2	9	22	32	16	10
9	13	12	10	22	32	18	10
10	14.3	12.9	11	21	32	23	10
11	15.5	14.3	12	21	32	27	10
12	16.8	15.5	13	21	32	29	10
13	18	16.4	14	21	32	32	10
14	19.3	17.9	16	20	32	37	10

## RS2300X/12 Socket Set on Rail Steckschlüsselsatz auf Schiene Jeu de douilles sur rail



RS2300X/12	12 Pieces Set/Rail 200mm	(g)
4, 5, 5.5, 6, 7, 8, 9, 10, 11, 12, 13, 14		270

## 2350X Nut Grip Socket, Semi-Deep Nut Grip® Steckschlüssel mit 2-facher Kugelhalterung, mittel-lang Douilles à billes de retenue, semi-profondes

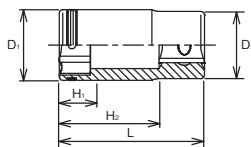

2350X (mm)	D <sub>1</sub> (mm)	D <sub>2</sub> (mm)	H <sub>1</sub> (mm)	H <sub>2</sub> (mm)	L (mm)	(g)	(pcs.)
8	12.3	11.7	5	21.5	32	17	10
10	14.3	12.9	6	21.5	32	22	10
12	16.8	16	7	21.5	32	34	10
14	20	18	8.5	21.5	32	43	10

## RS2350X/4 Socket Set on Rail Steckschlüsselsatz auf Schiene Jeu de douilles sur rail



RS2350X/4	4 Pieces Set/Rail 150mm	(g)
8, 10, 12, 14		140

# 1/4"

Hand Sockets  
Hand Steckschlüssel  
Douilles à main

2300M 2305A (mm)	D <sub>1</sub> (mm)	D <sub>2</sub> (mm)	H <sub>1</sub> (mm)	H <sub>2</sub> (mm)	L (mm)	(g)	(pcs.)
3	5.5	11.2	3	40	50	15	10
4	6.7	11.2	4	40	50	15	10
4.5	7.3	11.2	4.5	40	50	15	10
5	8	11.2	5.5	40	50	17	10
5.5	8.5	11.2	6	40	50	17	10
6	9.2	11.2	7	40	50	20	10
7	10.5	11.2	8	40	50	25	10
8	11.8	11.2	9	40	50	25	10
9	13	12	10	40	50	30	10
10	14.3	12.9	11	39	50	34	10
11	15.5	14.3	12	39	50	43	10
12	16.8	15.5	13	39	50	50	10
13	18	16.4	14	39	50	52	10
14	19.3	17.9	16	38	50	57	10



## 2300M / 2300A

6-point Deep Sockets  
6-kant-Steckschlüssel, lang  
Douilles longues 6-pans

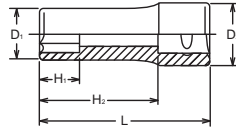

2300A 2305A (inch)	D <sub>1</sub> (mm)	D <sub>2</sub> (mm)	H <sub>1</sub> (mm)	H <sub>2</sub> (mm)	L (mm)	(g)	(pcs.)
1/8	5.7	11.2	3.5	40	50	15	10
5/32	6.7	11.2	4	40	50	15	10
3/16	7.8	11.2	5.5	40	50	17	10
7/32	8.5	11.2	6	40	50	17	10
1/4	9.8	11.2	7	40	50	25	10
9/32	10.5	11.2	8	40	50	25	10
5/16	11.8	11.2	9	40	50	25	10
11/32	12.5	11.7	10	40	50	30	10
3/8	13.7	12.5	11	40	50	34	10
7/16	15.5	14.3	12	39	50	43	10
1/2	18	16.4	14	39	50	52	10
9/16	19.3	17.9	16	38	50	57	10

## 2305M / 2305A

12-point Deep Sockets  
12-kant-Steckschlüssel, lang  
Douilles longues, 12-pans

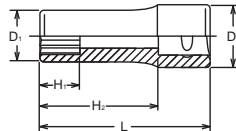

RS2300M/12	12 Pieces Set/Rail 200mm	(g)
<b>New</b>	4, 5, 5.5, 6, 7, 8, 9, 10, 11, 12, 13, 14	400

RS2305M/12	12 Pieces Set/Rail 200mm	(g)
<b>New</b>	4, 5, 5.5, 6, 7, 8, 9, 10, 11, 12, 13, 14	400

## RS2300M/12

Socket Set on Rail  
Steckschlüsselsatz auf Schiene  
Jeu de douilles sur rail

## RS2305M/12

Socket Set on Rail  
Steckschlüsselsatz auf Schiene  
Jeu de douilles sur rail



RS2300A/9	9 Pieces Set/Rail 150mm	(g)
	3/16, 7/32, 1/4, 9/32, 5/16, 11/32, 3/8, 7/16, 1/2	296

RS2305A/9	9 Pieces Set/Rail 150mm	(g)
	3/16, 7/32, 1/4, 9/32, 5/16, 11/32, 3/8, 7/16, 1/2	296

## RS2300A/9

Socket Set on Rail  
Steckschlüsselsatz auf Schiene  
Jeu de douilles sur rail

## RS2305A/9

Socket Set on Rail  
Steckschlüsselsatz auf Schiene  
Jeu de douilles sur rail



AS2305A (inch)	D <sub>1</sub> (mm)	D <sub>2</sub> (mm)	H <sub>1</sub> (mm)	H <sub>2</sub> (mm)	L (mm)	(g)	(pcs.)
3/16	7.7	10.9	6	40	50	17	10
7/32	8.5	10.9	6.5	40	50	17	10
1/4	9.4	10.9	7	40	50	19	10
9/32	10.2	10.9	8	40	50	18	10
5/16	11.3	11.7	9	40	50	23	10
11/32	12.5	12	10	40	50	24	10
3/8	13.7	12.8	11	39	50	31	10
7/16	15.6	14.2	12	39	50	38	10
1/2	17.2	16.2	14	39	50	42	10
9/16	18.8	17.1	16	38	50	47	10

Aerospace Standard SAE AS954

## AS2305A

12-point Deep Sockets, AS954  
12-kant Steckschlüssel, lang, AS954  
Douilles longues 12-pans, AS954

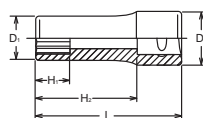

RSAS2305A/10	10 Pieces set/Rail 150mm	(g)
	3/16, 7/32, 1/4, 9/32, 5/16, 11/32, 3/8, 7/16, 1/2, 9/16	307

## RSAS2305A/10

Socket Set on Rail  
Steckschlüsselsatz auf Schiene  
Jeu de douilles sur rail



Z-SERIES  
HAND  
TITANIUM  
ACCESSORIES  
SCREWDRIVERS  
IMPACT  
SLEEVE-DRIVE  
PROTECTOR  
INDUSTRIAL  
AUTOMOTIVE  
MOTORCYCLE  
CONSTRUCTION  
SPARE PART

# Hand Sockets Hand Steckschlüssel Douilles à main

# 1/4"

Z-SERIES  
HAND  
TITANIUM  
SCREWDRIVERS ACCESSORIES  
IMPACT  
SLEEVE-DRIVE  
PROTECTOR  
INDUSTRIAL  
AUTOMOTIVE  
CONSTRUCTION MOTORCYCLE  
SPARE PART

## 2310M

Surface Drive Deep Sockets  
Surface Drive Steckschlüssel, lang  
Douilles longues, Surface Drive

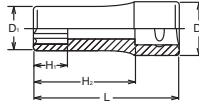

2310M (mm)	D <sub>1</sub> (mm)	D <sub>2</sub> (mm)	H <sub>1</sub> (mm)	H <sub>2</sub> (mm)	L (mm)	(g)	(pcs.)
3	5.5	11.2	3	40	50	15	10
4	6.7	11.2	4	40	50	15	10
4.5	7.3	11.2	4.5	40	50	15	10
5	8	11.2	5.5	40	50	17	10
5.5	8.5	11.2	6	40	50	17	10
6	9.2	11.2	7	40	50	20	10
7	10.5	11.2	8	40	50	25	10
8	11.8	11.2	9	40	50	25	10
9	13	12	10	40	50	30	10
10	14.3	12.9	11	39	50	34	10
11	15.5	14.3	12	39	50	43	10
12	16.8	15.5	13	39	50	50	10
13	18	16.4	14	39	50	52	10
14	19.3	17.9	16	38	50	57	10

## RS2310M/12

Socket Set on Rail  
Steckschlüsselsatz auf Schiene  
Jeu de douilles sur rail



RS2310M/12	12 Pieces set/Rail 200mm	(g)
New 4, 5, 5.5, 6, 7, 8, 9, 10, 11, 12, 13, 14		400

## 2300W-BA

6-point Deep Sockets  
6-kant-Steckschlüssel, lang  
Douilles longues 6-pans

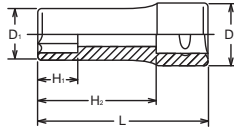

2300W (BA)	D <sub>1</sub> (mm)	D <sub>2</sub> (mm)	H <sub>1</sub> (mm)	H <sub>2</sub> (mm)	L (mm)	(g)	(pcs.)
4	9.8	11.2	7	40	50	22	10
3	10.5	11.2	8	40	50	25	10
2	11.8	11.2	9	40	50	25	10
1	13	12	10	40	50	30	10
0	14.9	13.6	12	39	50	38	10

BA



BA	8BA	7BA	6BA	5BA	4BA	3BA	2BA	1BA	0BA
Across Flat (ref. mm)	3.86	4.37	4.90	5.59	6.30	7.16	8.23	9.27	10.49
(ref. inch)	0.152	0.172	0.193	0.220	0.248	0.282	0.324	0.365	0.413

## 2325

TORX® Deep Sockets  
TORX® Steckschlüssel, lang  
Douilles longues TORX®

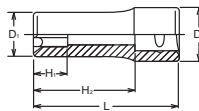

2325 (E)	D <sub>1</sub> (mm)	D <sub>2</sub> (mm)	H <sub>1</sub> (mm)	H <sub>2</sub> (mm)	L (mm)	(g)	(pcs.)
E 4	5.4	12	4.6	40	50	17	10
E 5	6.8	12	5.2	40	50	20	10
E 6	8	12	5.4	40	50	20	10
E 7	8.3	12	6.6	40	50	22	10
E 8	9.8	12	7	40	50	25	10
E10	11.6	12	8.2	40	50	29	10

TORX®  
(E)

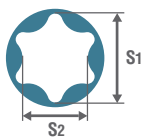

E	E4	E5	E6	E7	E8	E10	E11	E12	E14	E16	E18	E20	E22	E24	E26	E28	E30	E32
S <sub>1</sub> (ref. mm)	3.7	4.6	5.6	6.1	7.4	9.3	9.9	11.0	12.8	14.6	16.5	18.3	20.1	22.0	23.7	25.5	27.3	29.0
S <sub>2</sub> (ref. mm)	2.7	3.3	4.0	4.3	5.3	6.8	7.1	7.9	9.2	10.5	11.9	13.2	14.8	15.7	17.5	18.3	20.0	21.3

## 2350M

Nut Grip Deep Sockets **Nut Grip®**  
Steckschlüssel mit 2-facher Kugelhalterung, lang  
Douilles longues à billes de retenue

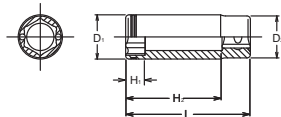

2350M (mm)	D <sub>1</sub> (mm)	D <sub>2</sub> (mm)	H <sub>1</sub> (mm)	H <sub>2</sub> (mm)	L (mm)	(g)	(pcs.)
8	12.3	11.7	5	39.5	50	30	10
10	14.3	12.9	6	39.5	50	35	10
12	16.8	16	7	39.5	50	55	10
14	20	18	8.5	39.5	50	70	10

## RS2350M/4

Socket Set on Rail  
Steckschlüsselsatz auf Schiene  
Jeu de douilles sur rail



RS2350M/4	4 Pieces Set/Rail 150mm	(g)
8, 10, 12, 14		220

# 1/4"

Hand Sockets  
Hand Steckschlüssel  
Douilles à main

2440M 2445M (mm)	D <sub>1</sub> (mm)	D <sub>2</sub> (mm)	H (mm)	L (mm)	(g)	(pcs.)
4	6.7	13	4.8	31.5	17	10
5	8	13	5.3	32	17	10
6	9.2	13	6.1	33	18	10
7	10.5	13	6.5	33	19	10
8	11.7	13	7	34	19	10
9	13	13	7	34	20	10
10	14.2	13	8.3	35	20	10
11	15.5	13	9.5	36	21	10
12	16.7	13	10	37	21	10
13	18	13	10.5	37	26	10
14	19.2	13	10.5	37	28	10

2440A (inch)	D <sub>1</sub> (mm)	D <sub>2</sub> (mm)	H (mm)	L (mm)	(g)	(pcs.)
1/4	9.8	13	6.5	33	18	10
5/16	11.7	13	7	34	19	10
3/8	13.7	13	8.3	35	20	10
7/16	15.5	13	9.5	36	21	10
1/2	18	13	10.5	37	26	10
9/16	19.2	13	10.5	37	28	10

2445A (inch)	D <sub>1</sub> (mm)	D <sub>2</sub> (mm)	H (mm)	L (mm)	(g)	(pcs.)
3/16	8	13	5.3	32	18	10
1/4	9.8	13	6.5	33	18	10
9/32	10.5	13	6.5	33	19	10
5/16	11.7	13	7	34	19	10
11/32	13	13	7	34	20	10
3/8	13.7	13	8.3	35	20	10
7/16	15.5	13	9.5	36	21	10
1/2	18	13	10.5	37	26	10
9/16	19.2	13	10.5	37	28	10

RS2445A/9	9 Pieces set/Rail 150mm	(g)
3/16, 1/4, 9/32, 5/16, 11/32, 3/8, 7/16, 1/2, 9/16		220

AS2445A (inch)	D <sub>1</sub> (mm)	D <sub>2</sub> (mm)	H (mm)	L (mm)	(g)	(pcs.)
1/4	9.6	12.9	5.7	31.8	18	10
5/16	11.7	12.9	7	34.6	21	10
3/8	13.5	12.9	8.3	35.1	21	10
7/16	15.5	12.9	9.5	39.1	25	10
1/2	17.2	12.9	10.5	40.1	27	10

2440T (E)	D <sub>1</sub> (mm)	D <sub>2</sub> (mm)	H (mm)	L (mm)	(g)	(pcs.)
E 6	8	13	5.4	31.9	20	10
E 8	9.8	13	7	33.1	20	10
E10	11.7	13	8.2	33.6	21	10
E12	14.2	13	9.3	35.1	24	10

2441M (mm)	D <sub>1</sub> (mm)	D <sub>2</sub> (mm)	H (mm)	L (mm)	(g)	(pcs.)
New 6	10.2	13	3.5	31.5	19	10
7	11.3	13	4	33	19	10
8	12.3	13	5	32	19	10
10	14.5	13	6	32.5	21	10
12	16.8	13	7	34	21	10
13	18	13	8	35	21	10
14	20	13	8.5	37	28	10



## 2440M / 2440A

6-point Universal Sockets  
6-kant Gelenk-Einsätze  
Douilles articulées, 6-pans

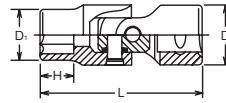

## 2445M / 2445A

12-point Universal Sockets  
12-kant Gelenk-Einsätze  
Douilles articulées, 12-pans

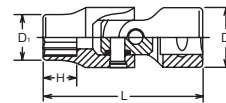

## RS2445A/9

Socket Set on Rail  
Steckschlüsselsatz auf Schiene  
Jeu de douilles sur rail



## AS2445A

12-point Universal Sockets  
12-kant Gelenk-Einsätze  
Douilles articulées, 12-pans

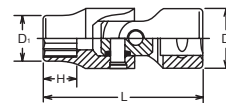

## 2440T

TORX® Universal Sockets  
TORX® Gelenk-Einsätze  
Douilles articulées TORX®

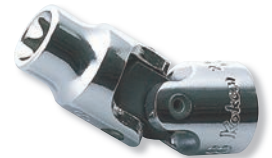
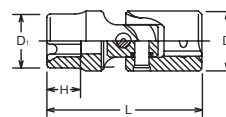

## 2441M

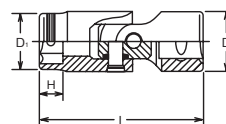

Nut Grip Universal Sockets **Nut Grip®**  
Gelenk-Einsätze mit zweifacher Kugelhalterung  
Douilles articulées à billes de retenue



# Hand Sockets Hand Steckschlüssel 1/4"

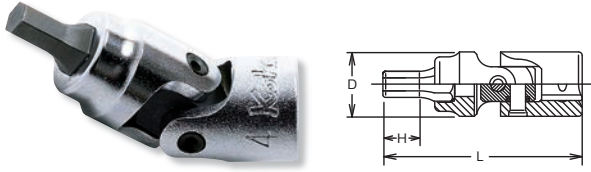

## 2430M Universal Hex Sockets Gelenk-Einsätze für Schrauben mit Innensechskant Douilles articulées, 6-pans mâles



2430M (mm)	D (mm)	H (mm)	L (mm)	 (g)	 (pcs.)
3	13	5.5	40	18	10
4	13	5.5	40	18	10
5	13	6.5	40	20	10
6	13	7.5	40	21	10

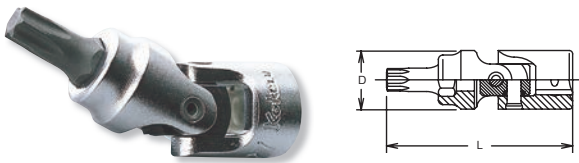

## 2430T TORX® Universal Sockets TORX® Gelenk-Einsätze Douilles articulées TORX®



2430T (T)	D (mm)	L (mm)	 (g)	 (pcs.)
T 8	13	42	22	10
T 9	13	42	22	10
T10	13	42	22	10
T15	13	42	22	10
T20	13	42	22	10
T25	13	42	22	10
T27	13	42	22	10
T30	13	42	22	10

## 2000-28 (PH) Phillips Bit Sockets Steckschlüssel für Kreuzschlitzschrauben, Phillips Douilles tournevis pour vis à empreinte Phillips



2000-28 (PH)	D (mm)	H (mm)	L (mm)	 (g)	 (pcs.)
1	11.9	12	28	10	10
2	11.9	12	28	11	10
3	11.9	12	28	12	10
4	13.1	11	28	14	10



## 2000-28 (PZ) PZ Bit Sockets Steckschlüssel für Kreuzschlitzschrauben, PZ Douilles tournevis pour vis à empreinte PZ

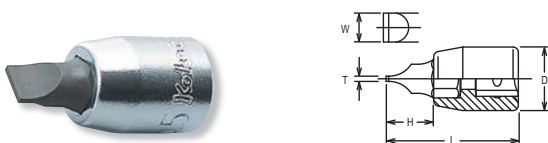

2000-28 (PZ)	D (mm)	H (mm)	L (mm)	 (g)	 (pcs.)
PZ1	11.9	12	28	10	10
PZ2	11.9	12	28	11	10
PZ3	11.9	12	28	12	10

## 2005-25 Bit Sockets for Slotted Head Steckschlüssel für Schlitzschrauben Douilles tournevis pour vis à fente



2005-25	TxW (mm)	D (mm)	H (mm)	L (mm)	 (g)	 (pcs.)
3	0.5x 3	11.9	9	25	9	10
4	0.8x 4	11.9	9	25	10	10
5	1.0x 5.5	11.9	9	25	10	10
6	1.2x 6.5	13.1	9	25	11	10
8	1.2x 8	13.1	9	25	12	10
9	1.6x 8	13.1	9	25	12	10
10	1.6x10	14.3	9	25	13	10

Z-SERIES  
HAND  
TITANIUM  
SCREWDRIVERS ACCESSORIES  
IMPACT  
SLEEVE-DRIVE  
PROTECTOR  
INDUSTRIAL  
AUTOMOTIVE  
MOTORCYCLE  
CONSTRUCTION  
SPARE PART



# 1/4"

Hand Sockets  
Hand Steckschlüssel  
Douilles à main

2010M-25 (mm)	D (mm)	H (mm)	L (mm)	(g)	(pcs.)
1.5	11.9	9	25	9	10
2	11.9	9	25	9	10
2.5	11.9	9	25	9	10
3	11.9	9	25	9	10
4	11.9	9	25	9	10
5	11.9	9	25	10	10
6	11.9	9	25	12	10
7	13.1	8	25	12	10
8	13.1	8	25	14	10
10	14.3	8	25	17	10
12	16.4	8	25	36	10

2010M-100 (mm)	D (mm)	H (mm)	L (mm)	(g)	(pcs.)
2	11.9	84	100	30	10
2.5	11.9	84	100	30	10
3	11.9	84	100	30	10
4	11.9	84	100	30	10
5	13.1	83	100	30	10
6	13.1	83	100	35	10
7	13.1	83	100	35	10
8	13.1	83	100	38	10
10	14.3	83	100	45	10
12	16.4	83	100	107	10

RS2010M/7-L25	7 Pieces set/Rail 150mm	(g)
3, 4, 5, 6, 7, 8, 10		115

RS2010A/8-L25	8 Pieces set/Rail 150mm	(g)
1/8, 5/32, 3/16, 7/32, 1/4, 9/32, 5/16, 3/8		130

2011M-50 (mm)	D (mm)	H (mm)	L (mm)	(g)	(pcs.)
3	11.9	34	50	16	10
4	11.9	34	50	17	10
5	11.9	34	50	18	10
6	11.9	34	50	18	10

Ball point bit sockets have less strength due to the special design. Make sure to use them correctly.



2020-28 (XZN)	D (mm)	H (mm)	L (mm)	(g)	(pcs.)
M4	11.9	12	28	12	10
M5	11.9	12	28	12	10
M6	11.9	12	28	13	10
M8	13.1	11	28	14	10

2020-50 (XZN)	D (mm)	H (mm)	L (mm)	(g)	(pcs.)
M4	11.9	34	50	20	10
M5	11.9	34	50	20	10
M6	11.9	34	50	22	10
M8	13.1	33	50	24	10

XZN

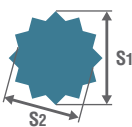

XZN		M4	M5	M6	M8	M10	M12	M14	M16	M18
S <sub>1</sub>	(ref. mm)	3.6	4.8	6.1	7.3	9.7	11.5	13.3	15.7	16.9
S <sub>2</sub>	(ref. mm)	3.1	4.1	5.1	6.1	8.1	9.7	11.2	13.2	14.2

## 2010M-25 / -100 2010A-25

Inhex Bit Sockets  
Steckschlüssel für Innensechskant-Schrauben  
 Douilles tournevis pour vis 6-pans creux

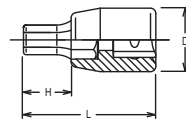

2010A-25 (inch)	D (mm)	H (mm)	L (mm)	(g)	(pcs.)
1/8	11.9	9	25	9	10
5/32	11.9	9	25	9	10
3/16	11.9	9	25	10	10
7/32	11.9	9	25	11	10
1/4	11.9	9	25	12	10
9/32	13.1	8	25	12	10
5/16	13.1	8	25	14	10
3/8	14.3	8	25	17	10

## RS2010M/7-L25 RS2010A/8-L25

Socket Set on Rail  
Steckschlüsselsatz auf Schiene  
 Jeu de douilles sur rail

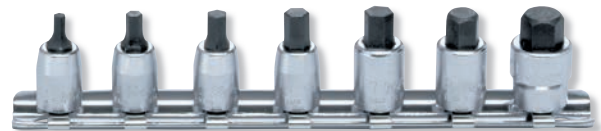

## 2011M-50

Ballpoint Inhex Sockets  
Steckschlüssel mit Kugelkopf, für Innensechskant-Schrauben  
 Douilles tournevis avec tête sphérique pour vis 6-pans creux

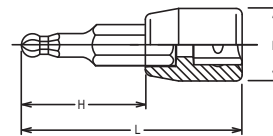

## 2020-28 / -50

XZN Bit Sockets  
Steckschlüssel für XZN Schrauben  
Douilles tournevis pour empreinte XZN

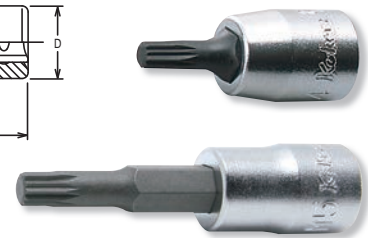
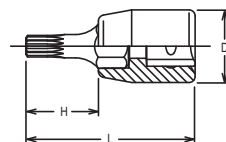

Z-SERIES  
HAND  
TITANIUM  
SCREWDRIVERS  
ACCESSORIES  
IMPACT  
SLEEVE-DRIVE  
PROTECTOR  
INDUSTRIAL  
AUTOMOTIVE  
MOTORCYCLE  
CONSTRUCTION  
SPARE PART

## 2025-28 / -80 (T)

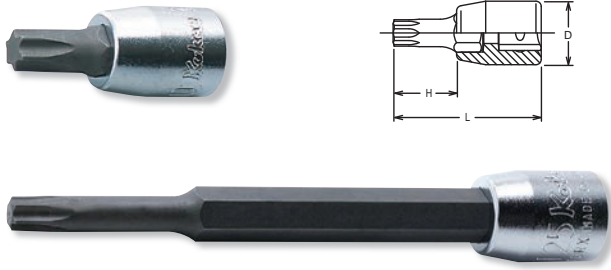

 TORX® Bit Sockets  
TORX® Bit-Steckschlüssel  
Douilles tournevis, TORX®



2025-28 (T)	D (mm)	H (mm)	L (mm)	(g)	(pcs.)
T 8	11.9	12	28	10	10
T 9	11.9	12	28	10	10
T10	11.9	12	28	10	10
T15	11.9	12	28	10	10
T20	11.9	12	28	11	10
T25	11.9	12	28	11	10
T27	11.9	12	28	12	10
T30	11.9	12	28	12	10
T40	11.9	12	28	13	10

2025-80 (T)	D (mm)	H (mm)	L (mm)	(g)	(pcs.)
T10	11.9	64	80	40	10
T15	11.9	64	80	40	10
T20	11.9	64	80	42	10
T25	11.9	64	80	42	10
T27	11.9	64	80	45	10
T30	11.9	64	80	45	10
T40	11.9	64	80	50	10

## RS2025/7-L28

  Socket Set on Rail  
Steckschlüsselsatz auf Schiene  
Jeu de douilles sur rail



RS2025/7-L28	7 Pieces set/Rail 150mm	(g)
T10, T15, T20, T25, T27, T30, T40		119

### TORX® (T)

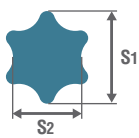

T	T8	T9	T10	T15	T20	T25	T27	T30	T40	T45	T50	T55	T60	T70	T80	T90	T100
S <sub>1</sub> (ref. mm)	2.3	2.5	2.7	3.3	3.9	4.5	5.0	5.6	6.7	7.9	8.9	11.3	13.3	15.6	17.6	20.0	22.2
S <sub>2</sub> (ref. mm)	1.7	1.8	2.0	2.3	2.8	3.2	3.6	4.0	4.8	5.6	6.2	8.0	9.5	11.1	12.7	14.2	15.8

## 2025-28 (TH)

 Tamper-Resistant TORX® Bit Sockets  
Tamper-Resistant TORX® Bit-Steckschlüssel  
Douilles tournevis, Tamper-Resistant TORX® 



2025-28 (TH)	D (mm)	H (mm)	L (mm)	(g)	(pcs.)
T10H	11.9	12	28	10	10
T15H	11.9	12	28	10	10
T20H	11.9	12	28	11	10
T25H	11.9	12	28	11	10
T27H	11.9	12	28	12	10
T30H	11.9	12	28	12	10
T40H	11.9	12	28	13	10

 Tamper Resistant TORX® Bit Sockets have less strength due to their special design. Make sure to use it correctly.

## RS2025/7-HOLE

  Socket Set on Rail  
Steckschlüsselsatz auf Schiene  
Jeu de douilles sur rail



RS2025/7-HOLE	7 Pieces set/Rail 150mm	(g)
T10H, T15H, T20H, T25H, T27H, T30H, T40H		119



# 1/4"

Hand Sockets  
Hand Steckschlüssel  
Douilles à main

2025-28 (IP)	D (mm)	H (mm)	L (mm)	(g)	(pcs.)
8IP	11.9	12	28	10	10
9IP	11.9	12	28	10	10
10IP	11.9	12	28	10	10
15IP	11.9	12	28	10	10
20IP	11.9	12	28	11	10
25IP	11.9	12	28	11	10
27IP	11.9	12	28	12	10
30IP	11.9	12	28	12	10
40IP	11.9	12	28	13	10

RS2025/7-IP	7 Pieces set/Rail 150mm	(g)
10IP, 15IP, 20IP, 25IP, 27IP, 30IP, 40IP		119

## 2025-28 (IP)



TORXPLUS® Bit Sockets  
TORXPLUS® Bit-Steckschlüssel  
Douilles tournevis, TORXPLUS®

**TORXplus®**

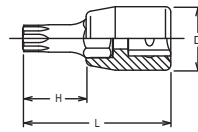

## RS2025/7-IP



Socket Set on Rail  
Steckschlüsselsatz auf Schiene  
Jeu de douilles sur rail



### TORXPLUS® (IP)

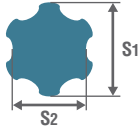

IP		8IP	9IP	10IP	15IP	20IP	25IP	27IP	30IP	40IP	45IP	50IP	55IP	60IP	70IP
S <sub>1</sub>	(ref. mm)	2.3	2.5	2.7	3.3	3.9	4.5	5.0	5.6	6.7	7.9	8.9	11.3	13.3	15.6
S <sub>2</sub>	(ref. mm)	1.7	1.8	2.0	2.3	2.8	3.2	3.6	4.0	4.8	5.6	6.2	8.0	9.5	11.1

2025-28 (IPR)	D (mm)	H (mm)	L (mm)	(g)	(pcs.)
8IPR	11.9	12	28	10	10
9IPR	11.9	12	28	10	10
10IPR	11.9	12	28	10	10
15IPR	11.9	12	28	10	10
20IPR	11.9	12	28	11	10
25IPR	11.9	12	28	11	10
27IPR	11.9	12	28	12	10
30IPR	11.9	12	28	12	10
40IPR	13.1	12	28	13	10

RS2025/7-IPR	7 Pieces set/Rail 150mm	(g)
10IPR, 15IPR, 20IPR, 25IPR, 27IPR, 30IPR, 40IPR		119

## 2025-28 (IPR)



TORXPLUS® Bit Sockets, with hole  
TORXPLUS® Bit-Steckschlüssel mit Stirnbohrung  
douilles tournevis TORXPLUS® avec trou

**TORXplus®**

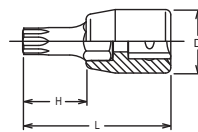

## RS2025/7-IPR



Socket Set on Rail  
Steckschlüsselsatz auf Schiene  
Jeu de douilles sur rail



### TORXPLUS® (IPR)

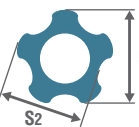

IPR		8IPR	9IPR	10IPR	15IPR	20IPR	25IPR	27IPR	30IPR	40IPR	45IPR	50IPR	55IPR
S <sub>1</sub>	(ref. mm)	2.2	2.4	2.6	3.1	3.6	4.1	4.7	5.2	6.3	7.4	8.4	10.6
S <sub>2</sub>	(ref. mm)	2.0	2.2	2.4	2.8	3.3	3.8	4.3	4.8	5.7	6.7	7.6	9.7

	D <sub>1</sub> (mm)	D <sub>2</sub> (mm)	L (mm)	(g)	(pcs.)
2137	12	12	22.5	13	10

For DIN3126 C6.3 Bits  
Für DIN3126 C6.3 Bits  
Pour DIN3126 C6.3 Embouts

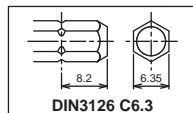

## 2137



Bit Holder  
Klingenhalter  
Porte-embouts

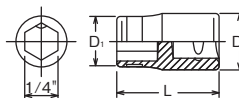

	D <sub>1</sub> (mm)	D <sub>2</sub> (mm)	L (mm)	(g)	(pcs.)
2138	16	16	26	32	10

For DIN3126 C8 Bits  
Für DIN3126 C8 Bits  
Pour DIN3126 C8 Embouts

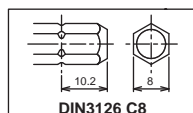

## 2138



Bit Holder  
Klingenhalter  
Porte-embouts

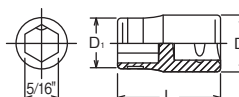

# Hand Sockets Hand Steckschlüssel Douilles à main

# 1/4"

Z-SERIES  
HAND  
TITANIUM  
SCREWDRIVERS ACCESSORIES  
IMPACT  
SLEEVE-DRIVE  
PROTECTOR  
INDUSTRIAL  
AUTOMOTIVE  
MOTORCYCLE  
CONSTRUCTION  
SPARE PART

**2753PS** Reversible Ratchet (Short)  
Knarre kurz, verstellbar  
Cliquet courte, réversible

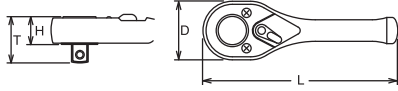

\* Renewal Kits → 2753RK → P304

	D (mm)	T (mm)	H (mm)	L (mm)	(g)	(pcs.)
2753PS	22	18.7	11.4	75	55	5

**2753J** Reversible Ratchet  
Knarre, verstellbar  
Cliquet, réversible



\* Renewal Kits → 2753RK → P304

**2753P** Reversible Ratchet  
Knarre, verstellbar  
Cliquet, réversible



\* Renewal Kits → 2753RK → P304

**2753N** Reversible Ratchet  
Knarre, verstellbar  
Cliquet, réversible



\* Renewal Kits → 2753RK → P304

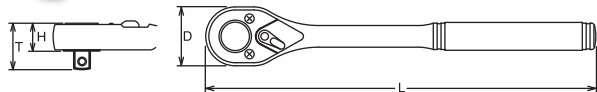

	D (mm)	T (mm)	H (mm)	L (mm)	(g)	(pcs.)
2753J	22	18.7	11.4	115	77	5
2753P	22	18.7	11.4	115	87	10
2753N	22	18.7	11.4	115	90	10

**2753P-160** Reversible Ratchet (Long) ⚠  
Verstellbare Knarre, lang  
Cliquet réversible, longue



\* Renewal Kits → 2753RK → P304

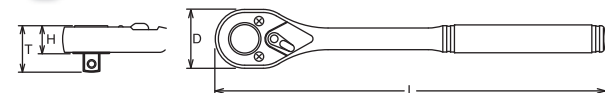

	D (mm)	T (mm)	H (mm)	L (mm)	(g)	(pcs.)
2753P-160	22	18.7	11.4	160	107	5

⚠ 2753P-160 have longer handle than standard, and can be loaded to excessive torque value. In the interest of your own safety always apply load evenly and progressively to avoid breakage and possible injury.

**2753JB** Reversible Ratchet with quick release button ⚠  
Knarre, verstellbar mit Entriegelungsknopf  
Cliquet, réversible avec bouton de débrayage



\* Renewal Kits → 2753BRK → P304

**2753PB** Reversible Ratchet with quick release button ⚠  
Knarre, verstellbar mit Entriegelungsknopf  
Cliquet, réversible avec bouton de débrayage



\* Renewal Kits → 2753BRK → P304

**2753NB** Reversible Ratchet with quick release button ⚠  
Knarre, verstellbar mit Entriegelungsknopf  
Cliquet, réversible avec bouton de débrayage



\* Renewal Kits → 2753BRK → P304

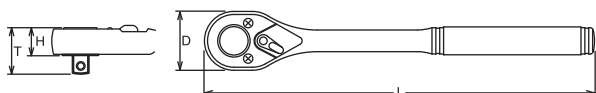

	D (mm)	T (mm)	H (mm)	L (mm)	(g)	(pcs.)
2753JB	22	18.7	11.4	115	77	5
2753PB	22	18.7	11.4	115	87	10
2753NB	22	18.7	11.4	115	90	10

⚠ **Reversible Ratchet with Quick Release Button :**  
Sockets and accessories are safely locked. By pushing the button the sockets or extension bars are released from the ratchet.

**Umstellbare Knarre mit Entriegelungsknopf :**  
Steckschlüssel und Zubehörteile werden sicher und fest gehalten. Bei Drücken des Knopfes lösen sich die Teile.

**Cliquet réversible à verrouillage :**  
Les douilles et accessoires ne peuvent plus tomber. Une pression du pouce sur le bouton suffit pour les libérer.

# 1/4" Hand Sockets Hand Steckschlüssel Douilles à main



\* Renewal Kits → 2753RK → P304



\* Renewal Kits → 2753RK → P304

	D (mm)	T (mm)	H (mm)	L (mm)	(g)	(pcs.)
2774JS	22	18.7	11.4	116	113	5
2774PS	22	18.7	11.4	116	110	5



\* Renewal Kits → 2753RK → P304



\* Renewal Kits → 2753RK → P304



\* Renewal Kits → 2753RK → P304

	D (mm)	T (mm)	H (mm)	L (mm)	(g)	(pcs.)
2774J	22	18.7	11.4	161	130	2
2774P	22	18.7	11.4	161	126	2
2774N	22	18.7	11.4	161	130	2



\* Renewal Kits → 2755RK → P306

	D (mm)	L (mm)	(g)	(pcs.)
2755	26	40	80	10

	D (mm)	L (mm)	(g)	(pcs.)
2756	22	20	19	10

**2774JS** Flexible Ratchet, reversible  
Gelenk-Knarre, verstellbar  
Cliquet articulé, réversible



**2774PS** Flexible Ratchet, reversible  
Gelenk-Knarre, verstellbar  
Cliquet articulé, réversible

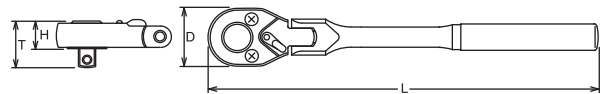

**2774J** Flexible Ratchet, reversible  
Gelenk-Knarre, verstellbar  
Cliquet articulé, réversible



**2774P** Flexible Ratchet, reversible  
Gelenk-Knarre, verstellbar  
Cliquet articulé, réversible



**2774N** Flexible Ratchet, reversible  
Gelenk-Knarre, verstellbar  
Cliquet articulé, réversible

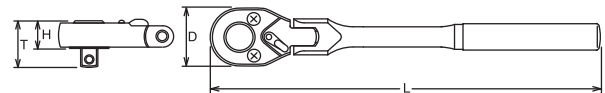

**2755** Ratchet Adaptor  
Aufsteckknarre  
Cliquet adaptable

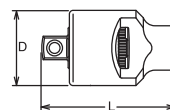

**2756** Quick Spinner  
Rändel-Drehscheibe  
Lanceur

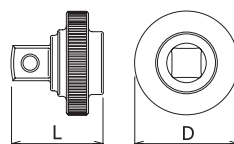

Z-SERIES  
HAND  
TITANIUM  
ACCESSORIES  
SCREWDRIVERS  
IMPACT  
SLEEVE-DRIVE  
PROTECTOR  
INDUSTRIAL  
AUTOMOTIVE  
MOTORCYCLE  
CONSTRUCTION  
SPARE PART

# Hand Sockets Hand Steckschlüssel Douilles à main

# 1/4"

Z-SERIES  
HAND  
TITANIUM  
SCREWDRIVERS  
ACCESSORIES  
IMPACT  
SLEEVE-DRIVE  
PROTECTOR  
INDUSTRIAL  
AUTOMOTIVE  
MOTORCYCLE  
CONSTRUCTION  
SPARE PART

## 2760 Extension Bars Verlängerungen Rallonges

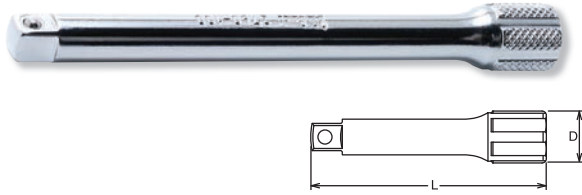

	D (mm)	L (mm)	(g)	(pcs.)
2760-28	12.3	28	14	10
2760-50	12.3	50	23	10
2760-75	12.3	75	35	10
2760-100	12.3	100	44	10
2760-150	12.3	150	63	10
2760-200	12.3	200	83	10
2760-250	12.3	250	103	10
2760-300	12.3	300	122	2
2760-350	12.3	350	145	2
2760-400	12.3	400	160	2
2760-600	12.3	600	240	2

## PK2760/6 Extension Set in Plastic Box Verlängerungen in Kunststoffkassette Jeu de rallonges en boîte plastique



PK2760/6	6 Pieces Set/△=430g
PLASTIC TRAY	
Extension Bars	
2760 Extension Bars 28, 50, 100, 150, 200, 250	

Rotation and general handling of extensions with oily hands is greatly improved with the **Koken** developed 6 point knurling. Also the **Koken** 6 point knurling stops the extensions from rolling around the work area.



Durch die von **Koken** entwickelte 6 fache Rändelung wird die Handhabung deutlich erleichtert. Außerdem wird das Herumrollen der Verlängerungen wirksam verhindert.

La manipulation des rallonges est grandement facilitée par le profil moleté développé par **Koken**. Ce même profil empêche le roulement intempestif des rallonges sur le plan de travail.

## 2763 Wobble-Fix Extension Bars Winkel-Verlängerungen Rallonges angulaires

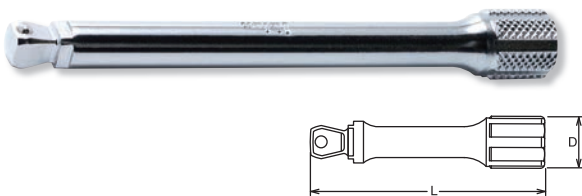

	D (mm)	L (mm)	(g)	(pcs.)
2763-28	12.3	28	14	10
2763-50	12.3	50	23	10
2763-75	12.3	75	33	10
2763-100	12.3	100	43	10
2763-150	12.3	150	62	10
2763-200	12.3	200	80	10
2763-250	12.3	250	100	10

## PK2763/6 Wobble-Fix Extension Bars in Plastic Box Winkel-Verlängerungen in Kunststoffkassette Jeu de rallonges angulaires en boîte plastique



PK2763/6	6 Pieces Set/△=420g
PLASTIC TRAY	
Extension Bars	
2763 Wobble-Fix Extension Bars 28, 50, 100, 150, 200, 250	

### Wobble-Fix Extension Bar

Two way usage

- In a fixed position, as a normal extension bar
- In a half-fixed position, as a flexible extension bar providing a 15° angle operation

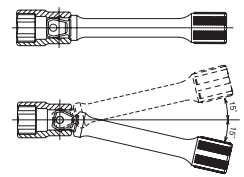

### Winkel-Verlängerungen

Winkelverlängerungen lassen sich in zwei Einstellungen verwenden

- voll eingesteckt und starr,
- halb eingesteckt, mit einem Arbeitswinkel von 15°.

### Rallonges angulaires

Deux utilisations possibles

- comme rallonge normale, dans une position fixe
- comme une rallonge angulaire avec une possibilité d'inclinaison jusqu'à 15°

**⚠** The Wobble-Fix Extension Bar has less strength than normal extension bar due to it's specific design with a reduced square drive. Make sure to use it correctly.

## 2762 Flexible Extension Bar Biegsame Verlängerung Rallonge flexible

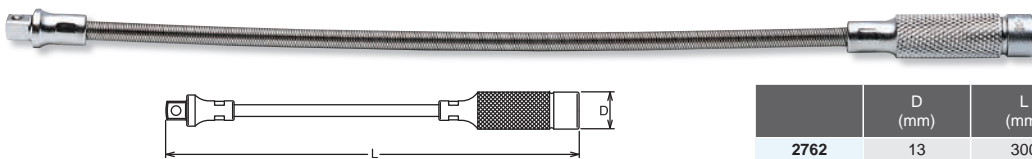

	D (mm)	L (mm)	(g)	(pcs.)
2762	13	300	90	2

## 2120 Magnetic Head Magnetkopf Tête aimantée

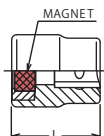

	L (mm)	(g)	(pcs.)
2120	17.5	21	10

\* Renewal Kits → 2768RK → P306

\* Renewal Kits → 2768RK → P306

	D (mm)	L (mm)	(g)	(pcs.)
2768J	14	130	73	5
2768P	14	130	70	10

	H (mm)	L (mm)	(g)	(pcs.)
2769N				
150	50	150	68	2
220	120	220	100	2

⚠ Plastic or rubber handles are not intended to act as insulation.

Plastik-oder Gummigriffe stellen keinen Isolierschutz dar.

Les poignées en plastique ou en caoutchouc ne garantissent aucune isolation électrique.



WOBBLE-FIX  
EXTENSION BAR



	H (mm)	L (mm)	(g)	(pcs.)
2769NWF				
150	50	150	68	2
220	120	220	100	2

	L (mm)	(g)	(pcs.)
2769H	160	180	10

**2768J** Hinge Handle  
Gelenkgriff  
Poignée articulée



**2768P** Hinge Handle  
Gelenkgriff  
Poignée articulée

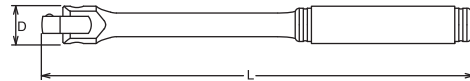

**2769N-150 / -220** Spin Type Handle  
Drehgriff  
Poignée emmanchée ⚠

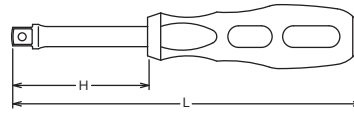

**2769NWF-150 / -220** Spin Type Handle(Wobble-Fix)  
Drehgriff, Wobble-Fix  
Poignée emmanchée, angulaire ⚠

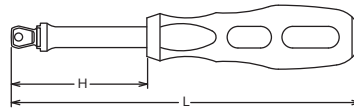

**2769H** Folding Socket Driver  
Klapp-Drehgriff  
Poignée tournevis articulée

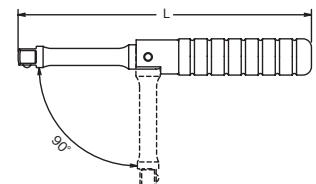

Z-SERIES  
HAND  
TITANIUM  
SCREWDRIVERS ACCESSORIES  
IMPACT  
SLEEVE-DRIVE  
PROTECTOR  
INDUSTRIAL  
AUTOMOTIVE  
MOTORCYCLE  
CONSTRUCTION  
SPARE PART

**2770** Universal Joint  
Gelenk-Einsatz  
Cardan universel

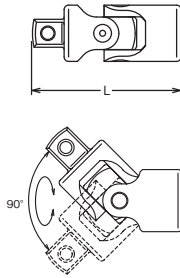

	L (mm)	(g)	(pcs.)
2770	33	20	10
2771	31	20	10

**2771** Universal Joint  
Gelenk-Einsatz  
Joint articulé

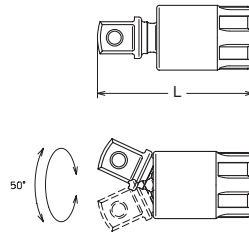

**2780** Speed Handle  
Winde  
Vilebrequin

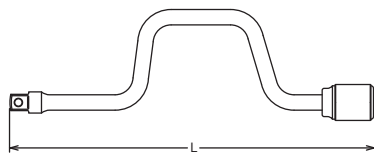

	L (mm)	(g)	(pce.)
2780	350	250	1

**2785** T-Handle  
T-Griff  
Poignée coulissante

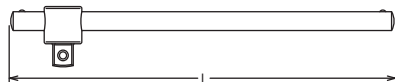



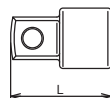

	L (mm)	(g)	(pcs.)
2785	115	36	10

**2233A** Adaptor  
Verbindungsstück  
Augmentateur



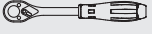



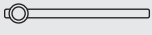





	(sq.)	(sq.)	L (mm)	(g)	(pcs.)
2233A	1/4"	3/8"	22	16	10

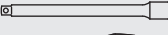

ESH2001		16 Pieces Set/△△=630g	
METAL CASE:W160xH100xT28mm			
Sockets	Accessories		
 <b>2410M</b> Surface Drive Sockets 4, 5, 5.5, 6, 7, 8, 9, 10, 11, 12, 13	 <b>2753J</b>	 <b>2763-50</b>	 <b>2760-150</b>
	 <b>2770</b>	 <b>2785</b>	







**ESH2001** Socket Set  
Steckschlüssel Satz  
Jeu de clés à douille

ENH2003		26 Pieces Set/△△=980g	
METAL CASE:W310xH86xT40mm			
Sockets	Accessories		
 <b>2400M</b> 6-pt. Sockets 5.5, 6, 7, 8, 9, 10, 11, 12, 13, 14	 <b>2753J</b>	 <b>2760-50</b>	 <b>2760-150</b>
 <b>108P</b> Phillips Bits 1, 2	 <b>2769N-150</b>	 <b>2770</b>	 <b>2785</b>
 <b>108S</b> Slotted Bits 4, 6, 8	 <b>2137</b>		
 <b>108H</b> Hex Bits 3, 4, 5, 6			



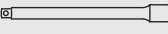
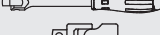

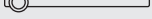

**ENH2003** Socket Set  
Steckschlüssel Satz  
Jeu de clés à douille





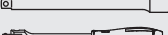

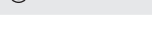



2251M		17 Pieces Set/△△=725g	
METAL CASE:W192xH122xT30mm			
Sockets	Accessories		
 <b>2400M</b> 6-pt. Sockets 4, 4.5, 5, 5.5, 6, 7, 8, 9, 10, 11, 13	 <b>2753J</b>	 <b>2760-50</b>	 <b>2760-150</b>
	 <b>2768J</b>	 <b>2770</b>	 <b>2785</b>

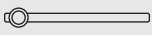

**2251M / 2251A** Socket Set  
Steckschlüssel Satz  
Jeu de clés à douille

2251A		15 Pieces Set/△△=700g	
METAL CASE:W192xH122xT30mm			
Sockets	Accessories		
 <b>2400A</b> 6-pt. Sockets 3/16, 7/32, 1/4, 9/32, 5/16, 11/32, 3/8, 7/16, 1/2	 <b>2753J</b>	 <b>2760-50</b>	 <b>2760-150</b>
	 <b>2768J</b>	 <b>2770</b>	 <b>2785</b>

**2258M** Socket Set  
Steckschlüssel Satz  
Jeu de clés à douille

2258M		31 Pieces Set/△△=965g	
METAL CASE:W240xH100xT32mm			
Sockets	Accessories		
 <b>2400M</b> 6-pt. Sockets 4, 4.5, 5, 5.5, 6, 7, 8, 9, 10, 11, 13	 <b>2753J</b>	 <b>2760-100</b>	 <b>2769N-150</b>
 <b>2000.28</b> Bit Sockets 1, 2, 3	 <b>2770</b>	 <b>2785</b>	
 <b>2005.25</b> Bit Sockets 4, 6			
 <b>2010M.25</b> Bit Sockets 3, 4, 5, 6, 8			
 <b>2025.28</b> Bit Sockets T10, T15, T20, T25, T30			



# Hand Sockets Hand Steckschlüssel Douilles à main

# 1/4"

Z-SERIES  
HAND  
TITANIUM  
SCREWDRIVERS  
ACCESSORIES  
IMPACT  
SLEEVE-DRIVE  
PROTECTOR  
INDUSTRIAL  
AUTOMOTIVE  
MOTORCYCLE  
CONSTRUCTION  
SPARE PART

**2259M** Socket Set  
Steckschlüssel Satz  
Jeu de clés à douille



2259M		31 Pieces Set/△=991g	
METAL CASE:W240xH100xT32mm			
Sockets		Accessories	
	<b>2400M</b> 6-pt. Sockets 4, 4.5, 5, 5.5, 6, 7, 8, 9, 10, 11, 13		<b>2774JS</b>
	<b>2000.28</b> Bit Sockets 1, 2, 3		<b>2760-100</b>
	<b>2005.25</b> Bit Sockets 4, 6		<b>2769N-150</b>
	<b>2010M.25</b> Bit Sockets 3, 4, 5, 6, 8		<b>2770</b>
	<b>2025.28</b> Bit Sockets T10, T15, T20, T25, T30		<b>2785</b>

**2263A** Socket Set  
Steckschlüssel Satz  
Jeu de clés à douille



2263A		29 Pieces Set/△=940g	
METAL CASE:W240xH100xT32mm			
Sockets		Accessories	
	<b>2400A</b> 6-pt. Sockets 1/8, 5/32, 3/16, 7/32, 1/4, 9/32, 5/16, 11/32, 3/8, 7/16, 1/2		<b>2753N</b>
	<b>2000.28</b> Bit Sockets 1, 2, 3		<b>2760-100</b>
	<b>2010A.25</b> Bit Sockets 1/8, 5/32, 3/16, 7/32, 1/4, 9/32, 5/16		<b>2769N-150</b>
	<b>2025.28</b> Bit Sockets T10, T15, T20, T25, T30		<b>2770</b>
			<b>2785</b>

**2275** Socket Set  
Steckschlüssel Satz  
Jeu de clés à douille



2275		19 Pieces Set/△=880g	
METAL CASE:W192xH122xT30mm			
Sockets		Accessories	
	<b>2400M</b> 6-pt. Sockets 5.5, 6, 7, 8, 10, 12, 13		<b>2753J</b>
	<b>2000.28</b> Bit Sockets 1, 2, 3		<b>2763-50</b>
	<b>2005.25</b> Bit Sockets 6, 8		<b>2769N-150</b>
	<b>2010M.25</b> Bit Sockets 3, 4, 5, 6		

**2276** Socket Set with Bits and Accessories  
Bit Satz mit Zubehör  
Jeu d'embouts et avec accessoires



2276		19 Pieces Set/△=640g	
METAL CASE:W192xH122xT30mm			
Bits		Accessories	
	<b>108P</b> Phillips Bits 1, 2, 3		<b>2753PS</b>
	<b>108S</b> Slotted Bits 4, 5, 6		<b>2769N-150</b>
	<b>108H</b> Hex Bits 3, 4, 5, 6		<b>2137</b>
	<b>108T</b> TORX® Bits T10, T15, T20, T25, T27, T30		

**2277** Socket Set  
Steckschlüssel Satz  
Jeu de clés à douille







2277		21 Pieces Set/△=1,240g	
METAL CASE:W310xH86xT50mm			
Sockets		Accessories	
	<b>2400M</b> 6-pt. Sockets 5.5, 6, 7, 8, 9, 10, 11, 12, 13		<b>2753J</b>
	<b>2300M</b> 6-pt. Deep Sockets 5.5, 6, 7, 8, 9, 10, 11, 12, 13		<b>2763-75</b>
			<b>2769N-150</b>

# 1/4"

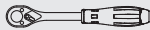

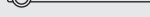

Hand Sockets  
Hand Steckschlüssel  
Douilles à main

Z-SERIES  
HAND  
TITANIUM  
ACCESSORIES  
SCREWDRIVERS  
IMPACT  
SLEEVE-DRIVE  
PROTECTOR  
INDUSTRIAL  
AUTOMOTIVE  
MOTORCYCLE  
CONSTRUCTION  
SPARE PART

P2201AM		25 Pieces Set/△=800g	
PLASTIC CASE:W245xH120xT45mm			
Sockets	Accessories		
<b>2400M</b> 6-pt. Sockets 4, 5, 5.5, 6, 7, 8, 9, 10, 11, 12, 13		<b>2753J</b>	
		<b>2760-100</b>	
<b>2400A</b> 6-pt. Sockets 3/16, 7/32, 1/4, 9/32, 5/16, 11/32, 3/8, 7/16, 1/2		<b>2769N-150</b>	
		<b>2770</b>	
		<b>2785</b>	



**P2201AM** Socket Set  
Steckschlüssel Satz  
Jeu de clés à douille

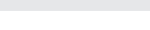

P2251M		18 Pieces Set/△=770g	
PLASTIC CASE:W245xH120xT45mm			
Sockets	Accessories		
<b>2400M</b> 6-pt. Sockets 4, 4.5, 5, 5.5, 6, 7, 8, 9, 10, 11, 12, 13		<b>2753J</b>	
		<b>2760-50</b>	
		<b>2760-150</b>	
		<b>2768J</b>	
		<b>2770</b>	
		<b>2785</b>	

**P2251M** Socket Set  
Steckschlüssel Satz  
Jeu de clés à douille

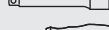
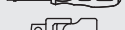

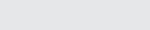
P2258M		31 Pieces Set/△=860g	
PLASTIC CASE:W245xH120xT45mm			
Sockets	Accessories		
<b>2400M</b> 6-pt. Sockets 4, 5, 5.5, 6, 7, 8, 9, 10, 11, 12, 13		<b>2753J</b>	
<b>2000.28</b> Bit Sockets 1, 2, 3		<b>2760-100</b>	
<b>2005.25</b> Bit Sockets 4, 6		<b>2769N-150</b>	
<b>2010M.25</b> Bit Sockets 3, 4, 5, 6, 8		<b>2770</b>	
<b>2025.28</b> Bit Sockets T10, T15, T20, T25, T30		<b>2785</b>	

**P2258M** Socket Set  
Steckschlüssel Satz  
Jeu de clés à douille



ABS Case - PE foam insert  
Kunststoffkassette - Weichschaumeinlage  
Coffret en ABS - Inserts en mousse

Z-SERIES  
HAND  
TITANIUM  
SCREWDRIVERS ACCESSORIES  
IMPACT  
SLEEVE-DRIVE  
PROTECTOR  
INDUSTRIAL  
AUTOMOTIVE  
MOTORCYCLE  
CONSTRUCTION  
SPARE PART

## 3400M / 3400A

6-point Sockets  
6-kant Steckschlüssel  
Douilles 6-pans

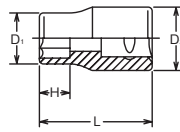

## 3405M / 3405A

12-point Sockets  
12-kant Steckschlüssel  
Douilles 12-pans

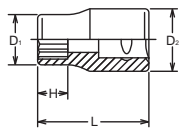

## FLAT DRIVE®

Flat drive is designed to guarantee a flat surface contact between the socket and the bolt/nut. The Flat contact reduces wear and allows to transmit a higher torque value. The Flat Drive System is also used for the square drive end as well as the hexagonal or bi-hexagonal openings of the socket.

Das Flat Drive Design sorgt für die optimale Kraftübertragung zwischen den Flächen des Steckschlüssels und der Schraube. Dies erlaubt eine Übertragung von höheren Drehmomenten. Das Flat Drive System findet ebenfalls bei allen Antriebsvierkanten sowie bei 6-kant und 12-kant Profilen Verwendung.

Le profil Flat Drive garantit un contact optimal entre la douille et l'écrou. Ce contact « à plat » réduit l'usure et permet la transmission d'un couple plus élevé. Ce système Flat Drive est utilisé pour tous les carrés conducteurs ainsi que pour toutes nos douilles 6-pans et 12-pans.

## RS3400M/12

Socket Set on Rail  
Steckschlüsselsatz auf Schiene  
Jeu de douilles sur rail



## RS3400A/9

Socket Set on Rail  
Steckschlüsselsatz auf Schiene  
Jeu de douilles sur rail



3400M 3405M (mm)	D <sub>1</sub> (mm)	D <sub>2</sub> (mm)	H (mm)	L (mm)	(g)	(pcs.)
5	8.3	17.3	5	26	20	10
5.5	8.9	17.3	5.5	26	20	10
6	9.9	17.3	6	26	20	10
7	10.8	17.3	6.5	26	20	10
8	12	17.3	7	26	22	10
9	13.3	17.3	7.5	26	23	10
10	14.5	17.3	8	26	24	10
11	15.8	17.3	8.5	26	25	10
12	16.8	17.3	9	26	25	10
13	18	17	9.5	26	24	10
14	19.5	18.5	11	27	31	10
15	20.8	19.5	11.5	28	39	10
16	22	20	12	28	42	10
17	23.3	21.5	12.5	29	51	10
18	24.5	22.5	13	30	51	10
19	25.8	23.5	13.5	30	63	10
20	27	24.5	14	31	75	10
21	28	26	14.5	32	77	10
22	29.5	26.5	15	32	82	10
23	30.8	27.5	15.5	33	95	10
24	32	28.5	16	34	102	10
25	33.3	29.5	16.5	34	115	5
26	34.5	30.5	17	35	129	5

3400A 3405A (inch)	D <sub>1</sub> (mm)	D <sub>2</sub> (mm)	H (mm)	L (mm)	(g)	(pcs.)
3/16	8.3	17.3	5	26	20	10
1/4	10.3	17.3	6	26	20	10
9/32	10.8	17.3	6.5	26	20	10
5/16	12	17.3	7	26	22	10
11/32	13.3	17.3	7.5	26	23	10
3/8	13.9	17.3	8	26	23	10
13/32	13.3	17.3	7.5	26	23	10
7/16	15.8	17.3	8.5	26	25	10
1/2	18	17	9.5	26	24	10
9/16	19.5	18.5	11	27	31	10
19/32	20.8	19.5	11.5	28	39	10
5/8	22	20	12	28	42	10
11/16	24.5	22.5	13	30	51	10
3/4	25.8	23.5	13.5	30	63	10
25/32	27	24.5	14	31	75	10
13/16	28	26	14.5	32	77	10
7/8	29.5	26.5	15	32	82	10
15/16	32	28.5	16	34	102	10
1	34.5	30.5	17	35	132	5

RS3400M/12	12 Pieces Set/Rail 300mm	(g)
8, 9, 10, 11, 12, 13, 14, 15, 16, 17, 18, 19		465

RS3405M/12	12 Pieces Set/Rail 300mm	(g)
8, 9, 10, 11, 12, 13, 14, 15, 16, 17, 18, 19		465

RS3400A/9	9 Pieces Set/Rail 200mm	(g)
1/4, 5/16, 3/8, 7/16, 1/2, 9/16, 5/8, 11/16, 3/4		333

RS3405A/9	9 Pieces Set/Rail 200mm	(g)
1/4, 5/16, 3/8, 7/16, 1/2, 9/16, 5/8, 11/16, 3/4		333

3410M (mm)	D <sub>1</sub> (mm)	D <sub>2</sub> (mm)	H (mm)	L (mm)	(g)	(pcs.)
5.5	8.9	17.3	5.5	26	20	10
6	9.9	17.3	6	26	20	10
7	10.8	17.3	6.5	26	20	10
8	12	17.3	7	26	22	10
9	13.3	17.3	7.5	26	23	10
10	14.5	17.3	8	26	24	10
11	15.8	17.3	8.5	26	25	10
12	16.8	17.3	9	26	25	10
13	18	17	9.5	26	24	10
14	19.5	18.5	11	27	31	10
15	20.8	19.5	11.5	28	39	10
16	22	20	12	28	42	10
17	23.3	21.5	12.5	29	51	10
18	24.5	22.5	13	30	51	10
19	25.8	23.5	13.5	30	63	10
20	27	24.5	14	31	75	10
21	28	26	14.5	32	77	10
22	29.5	26.5	15	32	82	10
23	30.8	27.5	15.5	33	95	10
24	32	28.5	16	34	102	10



## 3410M Surface Drive Sockets Surface Drive Steckschlüssel Douilles, Surface Drive

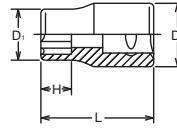

## SURFACE DRIVE

Surface drive sockets are designed to retain contact with the flat sides of the nut in order to transmit higher torque and reduce nut wear. These sockets are ideal for using on polished nuts, aluminum nuts and nuts with worn out points.

Das Profil unserer Surface-Drive Steckschlüssel greift die Schraube an deren Flächen. Dies sichert eine höhere Kraftübertragung und verhindert ein Durchrutschen des Steckschlüssels. Diese Steckschlüssel eignen sich besonders für polierte Schrauben, Aluminium Schrauben und Schrauben bei denen die Ecken bereits abgerundet sind.

Notre profil Surface Drive assure le contact entre la douille et les plats de l'écrou. Ceci réduit l'usure et permet la transmission d'un couple plus élevé. C'est une solution idéale pour les écrous polies, celles en aluminium ou arrondies.

RS3410M/12	12 Pieces Set/Rail 300mm	(g)
8, 9, 10, 11, 12, 13, 14, 15, 16, 17, 18, 19		468

## RS3410M/12 Socket Set on Rail Steckschlüsselsatz auf Schiene Jeu de douilles sur rail



3400W 3405W (W)	D <sub>1</sub> (mm)	D <sub>2</sub> (mm)	H (mm)	L (mm)	(g)	(pcs.)
1/8	13.3	17.3	7.5	26	22	10
3/16	15.8	17.3	8.5	26	25	10
1/4	18	17	9.5	26	24	10
5/16	20.8	19.5	11.5	28	39	10
3/8	24.5	22.5	13	30	51	10
7/16	28	26	14.5	32	81	10
1/2	30.8	27.5	15.5	33	103	10
9/16	34.5	30.5	17	35	128	5

## 3400W 6-point Whitworth Sockets 6-kant Steckschlüssel, Whitworth Douilles à 6-pans Whitworth

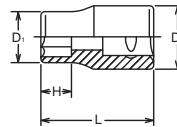

## 3405W 12-point Whitworth Sockets 12-kant Steckschlüssel, Whitworth Douilles à 12-pans Whitworth

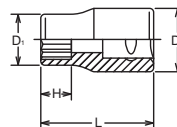

RS3400W/7	7 Pieces Set/Rail 200mm	(g)
1/8, 3/16, 1/4, 5/16, 3/8, 7/16, 1/2		389

## RS3400W/7 Socket Set on Rail Steckschlüsselsatz auf Schiene Jeu de douilles sur rail



RS3405W/7	7 Pieces Set/Rail 200mm	(g)
1/8, 3/16, 1/4, 5/16, 3/8, 7/16, 1/2		389

BS W	BS W													
	BS - W	BS	3/16BS	1/4BS	5/16BS	3/8BS	7/16BS	1/2BS	9/16BS	5/8BS	11/16BS	3/4BS	7/8BS	
		W	1/8W	3/16W	1/4W	5/16W	3/8W	7/16W	1/2W	9/16W	5/8W	11/16W	3/4W	
Across Flat	(ref. mm)	8.64	11.30	13.34	15.24	18.03	20.83	23.37	25.65	27.94	30.48	33.35		

## 3415M / 3415A

Double 4-point Sockets  
Doppelvierkant Steckschlüssel  
Douilles 4-pans, doubles

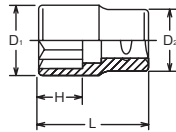

## 3425

TORX® Sockets  
TORX® Steckschlüssel  
Douilles TORX®

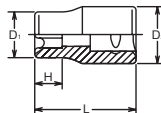

## RS3425/9

Socket Set on Rail  
Steckschlüsselsatz auf Schiene  
Jeu de douilles sur rail



## RSX425/14

Socket Set on Rail  
Steckschlüsselsatz auf Schiene  
Jeu de douilles sur rail



### TORX® (E)

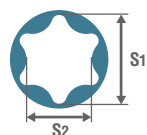

E	E4	E5	E6	E7	E8	E10	E11	E12	E14	E16	E18	E20	E22	E24	E26	E28	E30	E32
S <sub>1</sub> (ref. mm)	3.7	4.6	5.6	6.1	7.4	9.3	9.9	11.0	12.8	14.6	16.5	18.3	20.1	22.0	23.7	25.5	27.3	29.0
S <sub>2</sub> (ref. mm)	2.7	3.3	4.0	4.3	5.3	6.8	7.1	7.9	9.2	10.5	11.9	13.2	14.8	15.7	17.5	18.3	20.0	21.3

## 3400LH

LHSTIX® Sockets  
Steckschlüssel mit LHSTIX® Profil  
Douilles au profil LHSTIX®

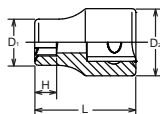

## RS3400LH/7

Socket Set on Rail  
Steckschlüsselsatz auf Schiene  
Jeu de douilles sur rail



### LHSTIX®

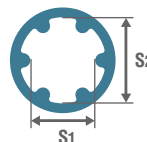

LH-S	LH-5S	LH-6S	LH-8S	LH-10S	LH-12S	LH-14S	LH-16S
S <sub>1</sub> (ref. mm)	5.6	6.8	9.0	11.3	13.6	15.8	18.1
S <sub>2</sub> (ref. mm)	7.5	9.0	12.0	15.0	18.0	21.0	24.0

3415M (mm)	D <sub>1</sub> (mm)	D <sub>2</sub> (mm)	H (mm)	L (mm)	(g)	(pcs.)
5.5	10.8	17.4	5.5	26	21	10
6	12	17.3	6	26	26	10
7	13.3	17.4	6.5	26	26	10
8	14.5	17.3	7	26	26	10
10	16.8	17.3	8	26	27	10
12	20.8	19.5	9	27	43	10
13	21.9	20	9.5	27	46	10

3415A (inch)	D <sub>1</sub> (mm)	D <sub>2</sub> (mm)	H (mm)	L (mm)	(g)	(pcs.)
1/4	12	17.3	6	26	24	10
5/16	14.5	17.3	7	26	26	10
11/32	15.8	17.3	7.5	26	27	10
3/8	16.8	17.3	8	26	27	10
7/16	19.5	18.5	8.5	27	37	10
1/2	22	20	9.5	27	46	10

3425 (E)	D <sub>1</sub> (mm)	D <sub>2</sub> (mm)	H (mm)	L (mm)	(g)	(pcs.)
E 4	5.6	17.3	4.6	26	18	10
E 5	7	17.3	5.2	26	20	10
E 6	8.3	17.3	5.4	26	21	10
E 7	8.9	17.3	6.6	26	22	10
E 8	9.9	17.3	7	26	23	10
E10	12	17.3	8.2	26	24	10
E11	13.3	17.3	8.7	26	25	10
E12	14.5	17.3	9.3	26	26	10
E14	15.8	17.3	10.6	26	27	10
E16	18	17	11.8	26	27	10

RS3425/9	9 Pieces Set/Rail 200mm	(g)
E4, E5, E6, E7, E8, E10, E12, E14, E16		239

RSX425/14	14 Pieces Set/Rail 300mm	(g)
2425	1/4"	E4, E5, E6, E7, E8
3425	3/8"	E10, E11, E12, E14
4425	1/2"	E16, E18, E20, E22, E24
		550

3400LH (LH-S)	D <sub>1</sub> (mm)	D <sub>2</sub> (mm)	H (mm)	L (mm)	(g)	(pcs.)
5S	10.8	17.3	5	26	20	10
6S	12	17.3	5.6	26	22	10
8S	15.8	17.3	6.8	26	25	10
10S	18	17	8	26	25	10
12S	22	20	9.2	28	42	10
14S	24.5	22.5	10.4	30	51	10
16S	28	26	11.6	32	77	10

RS3400LH/7	7 Pieces Set/Rail 150mm	(g)
5S, 6S, 8S, 10S, 12S, 14S, 16S		315

TORX is a registered trademark of Acument Intellectual Properties, LLC.  
TORX ist ein registriertes Markenzeichen der Firma Acument Intellectual Properties, LLC.  
TORX est une marque déposée de Acument Intellectual Properties, LLC.

LHSTIX is a registered trademark of OSG SYSTEM PRODUCTS CO., LTD.  
LHSTIX ist ein registriertes Markenzeichen der Firma OSG SYSTEM PRODUCTS CO., LTD.  
LHSTIX est une marque déposée de OSG SYSTEM PRODUCTS CO., LTD.

3450M (mm)	D <sub>1</sub> (mm)	D <sub>2</sub> (mm)	H (mm)	L (mm)	(g)	(pcs.)
8	12	17.3	5	26	21	10
10	14.5	17.3	6	26	24	10
11	15.8	17.3	6.5	26	26	10
12	16.8	17.3	7	26	26	10
13	18	17	8	26	28	10
14	19.5	18.5	8.5	27	34	10
15	20.8	19.5	9	27	42	10
16	22	20	9	27	50	10
17	23.3	21.5	9.5	28	62	10
18	24.5	22.5	10.5	29	64	10
19	25.8	23.3	11.5	29	66	10
21	28	26	12	29	85	10
22	29.5	27	12.5	29	90	10
24	32	30	14.5	31	102	10



## 3450M

Nut Grip Sockets **Nut Grip**<sup>®</sup>  
Steckschlüssel mit 2-facher Kugelhalterung  
Douilles à billes de retenue

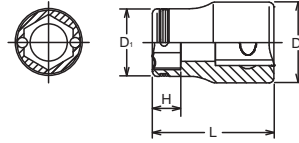

## NUT GRIP<sup>®</sup>

Twin balls at the 6-point opening hold bolt/nut tightly for safe and reliable work.

Die zwei Kugeln in der 6-kant Öffnung unserer NUT GRIP Steckschlüssel halten die Schraube sicher im Steckschlüssel. Dies erlaubt ein Arbeiten auch an schwer zugänglichen Stellen.

Les 2 billes dans l'ouverture du 6-pans de la douille retiennent l'écrou de manière sûre et efficace.

RS3450M/8	8 Pieces Set/Rail 200mm	(g)
8, 10, 11, 12, 13, 14, 17, 19		310

## RS3450M/8

Socket Set on Rail  
Steckschlüsselsatz auf Schiene  
Jeu de douilles sur rail



3450MH (mm)	D (mm)	H <sub>1</sub> (mm)	H <sub>2</sub> (mm)	L (mm)	(g)	(pcs.)
New 8	12	5	17	26	30	10
New 10	14.5	6	17	26	30	10
New 12	16.8	7	17	26	29	10
New 13	18	8	17	26	28	10
New 14	19.5	8.5	17	27	32	10
New 17	23.3	9.5	17	29	41	10

## 3450MH

Nut Grip Socket wrench with additional hexagon drive  
Nut Grip Steckschlüssel mit zusätzlichem Aussensechskant  
Douilles à deux billes de retenue avec tête hexagonale supplémentaire

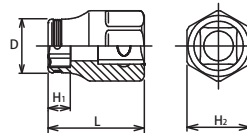

RS3450MH/6	6 Pieces Set/Rail 150mm	(g)
8, 10, 12, 13, 14, 17		230

## RS3450MH/6

Socket Set on Rail  
Steckschlüsselsatz auf Schiene  
Jeu de douilles sur rail



3425 (E)	D <sub>1</sub> (mm)	D <sub>2</sub> (mm)	H (mm)	L (mm)	(g)	(pcs.)
E10(2B)	12	17.3	8.2	26	23	10
E12(2B)	14.5	17.3	9.3	26	25	10
E14(2B)	15.8	17.3	10.6	26	26	10
E16(2B)	18.1	17	11.8	26	27	10
E18(2B)	19.5	18.5	12	32	41	10
E20(2B)	21.9	20	14.4	32	52	10

## 3425 (2B)

TORX<sup>®</sup> Sockets **Nut Grip**<sup>®</sup>  
TORX Steckschlüssel mit 2-facher Kugelhalterung  
Douilles Torx à deux billes de retenue

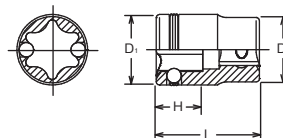

RS3425/4(2B)	4 Pieces Set/Rail 150mm	(g)
E10, E12, E14, E20		150

## RS3425/4 (2B)

Socket Set on Rail  
Steckschlüsselsatz auf Schiene  
Jeu de douilles sur rail



**TORX** is a registered trademark of Acument Intellectual Properties, LLC.  
**TORX** ist ein registriertes Markenzeichen der Firma Acument Intellectual Properties, LLC.  
**TORX** est une marque déposée de Acument Intellectual Properties, LLC.

**NUT GRIP** is a registered trademark of OSG SYSTEM PRODUCTS CO., LTD.  
**NUT GRIP** ist ein registriertes Markenzeichen der Firma OSG SYSTEM PRODUCTS CO., LTD.  
**NUT GRIP** est une marque déposée de OSG SYSTEM PRODUCTS CO., LTD.

## 3300X / 3300XA

6-point Sockets, Semi-Deep  
6-kant Steckschlüssel, mittel-lang  
Douilles, semi-profondes 6-pans



FLAT DRIVE®

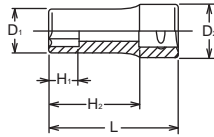

3300X 3305X (mm)	D <sub>1</sub> (mm)	D <sub>2</sub> (mm)	H <sub>1</sub> (mm)	H <sub>2</sub> (mm)	L (mm)	(g)	(pcs.)
8	12	17.3	9	26.5	40	34	10
9	13	17.3	10	26.5	40	36	10
10	14.5	17.3	11	26.5	40	36	10
11	16	17.2	12	26.5	40	36	10
12	16.8	17.2	13	26.5	40	36	10
13	18	17	14	26.5	40	37	10
14	20	18	16	26.5	40	46	10
15	21	20	16	25.5	40	49	10
16	22	20	17	25.5	40	51	10
17	23.5	22	18	25.5	40	61	10
18	24.5	23	19	24.5	40	68	10
19	25	24	20	24.5	40	75	10

## 3305X / 3305XA

12-point Sockets, Semi-Deep  
12-kant Steckschlüssel, mittel-lang  
Douilles, semi-profondes 12-pans

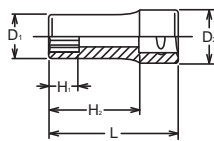

3300XA 3305XA (inch)	D <sub>1</sub> (mm)	D <sub>2</sub> (mm)	H <sub>1</sub> (mm)	H <sub>2</sub> (mm)	L (mm)	(g)	(pcs.)
1/4	10.3	17.3	7	26.5	40	32	10
5/16	12	17.3	9	26.5	40	34	10
3/8	13.9	17.3	11	26.5	40	36	10
7/16	16	17.2	12	26.5	40	36	10
1/2	18	17	14	26.5	40	37	10
9/16	20	18.5	16	26.5	40	46	10
5/8	22	20	17	25.5	40	51	10
11/16	24.5	22.5	19	24.5	40	68	10
3/4	25	23.5	20	24.5	40	75	10

## RS3300X/8 RS3305X/8

Socket Set on Rail  
Steckschlüsselsatz auf Schiene  
Jeu de douilles sur rail



RS3300X/8	8 Pieces Set/Rail 200mm	(g)
8, 10, 11, 12, 13, 14, 17, 19		405

RS3305X/8	8 Pieces Set/Rail 200mm	(g)
8, 10, 11, 12, 13, 14, 17, 19		405

## RS3300XA/9 RS3305XA/9

Socket Set on Rail  
Steckschlüsselsatz auf Schiene  
Jeu de douilles sur rail



RS3300XA/9	9 Pieces Set/Rail 200mm	(g)
1/4, 5/16, 3/8, 7/16, 1/2, 9/16, 5/8, 11/16, 3/4		460

RS3305XA/9	9 Pieces Set/Rail 200mm	(g)
1/4, 5/16, 3/8, 7/16, 1/2, 9/16, 5/8, 11/16, 3/4		460

## 3350X

Nut Grip Socket, Semi-Deep **Nut Grip®**  
Steckschlüssel mit 2-facher Kugelhalterung, mittel-lang  
Douilles à billes de retenue, semi-profondes



NUT GRIP®

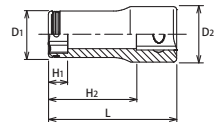

3350X (mm)	D <sub>1</sub> (mm)	D <sub>2</sub> (mm)	H <sub>1</sub> (mm)	H <sub>2</sub> (mm)	L (mm)	(g)	(pcs.)
8	12	17.4	5	26.5	40	33	10
10	14.5	17.4	6	26.5	40	35	10
12	16.8	17.2	7	26.5	40	40	10
14	19.5	18.5	8.5	26.5	40	48	10

## RS3350X/4

Socket Set on Rail  
Steckschlüsselsatz auf Schiene  
Jeu de douilles sur rail



RS3350X/4	4 Pieces Set/Rail 150mm	(g)
8, 10, 12, 14		165



3300M 3305M (mm)	D <sub>1</sub> (mm)	D <sub>2</sub> (mm)	H <sub>1</sub> (mm)	H <sub>2</sub> (mm)	L (mm)	(g)	(pcs.)
5.5	8.9	17.3	6.5	41.5	55	37	10
6	9.9	17.3	7	41.5	55	37	10
7	10.6	17.3	8	41.5	55	37	10
8	12	17.3	9	41.5	55	40	10
9	13	17.3	10	41.5	55	42	10
10	14.5	17.3	11	41.5	55	46	10
11	16	17.2	12	41.5	55	51	10
12	16.8	17.2	13	41.5	55	52	10
13	18	17	14	41.5	55	53	10
14	20	18	16	41.5	55	60	10
15	21	20	16	40.5	55	74	10
16	22	20	17	40.5	55	76	10
17	23.5	22	18	40.5	55	93	10
18	24.5	23	19	39.5	55	98	10
19	25	24	20	39.5	55	98	10
20	26	25	21	49.5	65	126	10
21	27	26	22	49.5	65	126	10
22	29	28	23	48.5	65	163	10
23	30	29	24	48.5	65	168	10
24	31	30	25	47.5	65	191	10
25	33	30	26	47.5	65	199	10
26	34	31	27	47.5	65	209	10
27	35	32.5	28	47.5	65	218	10

3300A 3305A (inch)	D <sub>1</sub> (mm)	D <sub>2</sub> (mm)	H <sub>1</sub> (mm)	H <sub>2</sub> (mm)	L (mm)	(g)	(pcs.)
7/32	8.9	17.3	6	41.5	55	35	10
1/4	9.9	17.3	7	41.5	55	37	10
5/16	12	17.3	9	41.5	55	40	10
11/32	12.3	17.3	10	41.5	55	41	10
3/8	14	17.3	11	41.5	55	46	10
7/16	16	17.2	12	41.5	55	51	10
1/2	18	17	14	41.5	55	53	10
9/16	20	18	16	41.5	55	60	10
19/32	21	20	16	40.5	55	74	10
5/8	22	20	17	40.5	55	76	10
11/16	23.5	22	18	40.5	55	93	10
3/4	25	24	20	39.5	55	98	10
13/16	27	26	22	49.5	65	126	10
7/8	29	28	23	48.5	65	163	10
15/16	31	30	25	47.5	65	191	10

RS3300M/12	12 Pieces Set/Rail 300mm	(g)
8, 9, 10, 11, 12, 13, 14, 15, 16, 17, 18, 19		878

RS3305M/12	12 Pieces Set/Rail 300mm	(g)
8, 9, 10, 11, 12, 13, 14, 15, 16, 17, 18, 19		878

RS3300A/9	9 Pieces Set/Rail 200mm	(g)
1/4, 5/16, 3/8, 7/16, 1/2, 9/16, 5/8, 11/16, 3/4		628

RS3305A/9	9 Pieces Set/Rail 200mm	(g)
1/4, 5/16, 3/8, 7/16, 1/2, 9/16, 5/8, 11/16, 3/4		628

## 3300M / 3300A

6-point Deep Sockets  
6-kant-Steckschlüssel, lang  
Douilles longues 6-pans

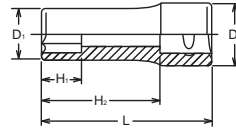

## 3305M / 3305A

12-point Deep Sockets  
12-kant Steckschlüssel, lang  
Douilles longues, 12-pans

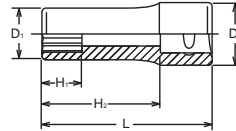

## RS3300M/12

Socket Set on Rail  
Steckschlüsselsatz auf Schiene  
Jeu de douilles sur rail

## RS3305M/12



## RS3300A/9

Socket Set on Rail  
Steckschlüsselsatz auf Schiene  
Jeu de douilles sur rail

## RS3305A/9



# Hand Sockets Hand Steckschlüssel Douilles à main

## 3/8"

Z-SERIES  
HAND  
TITANIUM  
SCREWDRIVERS ACCESSORIES  
IMPACT  
SLEEVE-DRIVE  
PROTECTOR  
INDUSTRIAL  
AUTOMOTIVE  
CONSTRUCTION MOTORCYCLE  
SPARE PART

### 3310M

Surface Drive Deep Sockets  
Surface Drive Steckschlüssel, lang  
Douilles longues, Surface Drive

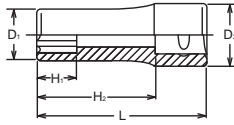

3310M (mm)	D <sub>1</sub> (mm)	D <sub>2</sub> (mm)	H <sub>1</sub> (mm)	H <sub>2</sub> (mm)	L (mm)	(g)	(pcs.)
6	9.9	17.3	7	41.5	55	37	10
7	10.6	17.3	8	41.5	55	37	10
8	12	17.3	9	41.5	55	40	10
9	13	17.3	10	41.5	55	42	10
10	14.5	17.3	11	41.5	55	46	10
11	16	17.2	12	41.5	55	51	10
12	16.8	17.2	13	41.5	55	52	10
13	18	17	14	41.5	55	53	10
14	20	18	16	41.5	55	60	10
15	21	20	16	40.5	55	74	10
16	22	20	17	40.5	55	76	10
17	23.5	22	18	40.5	55	93	10
18	24.5	23	19	39.5	55	98	10
19	25	24	20	39.5	55	98	10
20	26	25	21	49.5	65	126	10
21	27	26	22	49.5	65	126	10
22	29	28	23	48.5	65	163	10
23	30	29	24	48.5	65	168	10
24	31	30	25	47.5	65	161	10

### RS3310M/12

Socket Set on Rail  
Steckschlüsselsatz auf Schiene  
Jeu de douilles sur rail



RS3310M/12	12 Pieces Set/Rail 300mm	(g)
8, 9, 10, 11, 12, 13, 14, 15, 16, 17, 18, 19		881

### 3300W

6-point Deep Whitworth Sockets  
6-kant Steckschlüssel, lang, Whitworth  
Douilles longues à 6-pans Whitworth

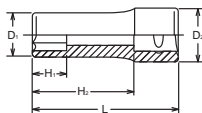

3300W 3305W (W)	D <sub>1</sub> (mm)	D <sub>2</sub> (mm)	H <sub>1</sub> (mm)	H <sub>2</sub> (mm)	L (mm)	(g)	(pcs.)
1/8	12.3	17.3	10	41.5	55	46	10
3/16	16	17.3	12	41.5	55	55	10
1/4	18	17	14	41.5	55	57	10
5/16	21	20	16	40.5	55	79	10
3/8	24.5	23	19	39.5	55	96	10
7/16	27	26	22	49.5	65	140	10
1/2	30	29	24	48.5	65	193	10
9/16	34	31	27	47.5	65	250	10

### 3305W

12-point Deep Whitworth Sockets  
12-kant Steckschlüssel, Whitworth  
Douilles longues à 12-pans Whitworth

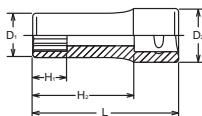

### RS3300W/7 RS3305W/7

Socket Set on Rail  
Steckschlüsselsatz auf Schiene  
Jeu de douilles sur rail



RS3300W/7	7 Pieces Set/Rail 200mm	(g)
1/8, 3/16, 1/4, 5/16, 3/8, 7/16, 1/2		719

RS3305W/7	7 Pieces Set/Rail 200mm	(g)
1/8, 3/16, 1/4, 5/16, 3/8, 7/16, 1/2		719

### BS W



BS - W	BS	3/16BS	1/4BS	5/16BS	3/8BS	7/16BS	1/2BS	9/16BS	5/8BS	11/16BS	3/4BS	7/8BS
	W	1/8W	3/16W	1/4W	5/16W	3/8W	7/16W	1/2W	9/16W	5/8W	11/16W	3/4W
Across Flat	(ref. mm)	8.64	11.30	13.34	15.24	18.03	20.83	23.37	25.65	27.94	30.48	33.35

3325 (E)	D <sub>1</sub> (mm)	D <sub>2</sub> (mm)	H <sub>1</sub> (mm)	H <sub>2</sub> (mm)	L (mm)	(g)	(pcs.)
E 4	5.6	17.3	4.6	41.5	55	29	10
E 5	6.9	17.3	5.2	41.5	55	31	10
E 6	7.9	17.3	5.4	41.5	55	33	10
E 7	8.9	17.3	6.6	41.5	55	36	10
E 8	9.9	17.3	7	41.5	55	39	10
E10	11.8	17.3	8.2	41.5	55	43	10
E12	14.5	17.2	9.3	41.5	55	53	10
E14	15.7	17.2	10.6	41.5	55	57	10
E16	18	17	11.8	41.5	55	69	10

RS3325/9	9 Pieces Set/Rail 200mm	(g)
E4, E5, E6, E7, E8, E10, E12, E14, E16		420

## 3325 TORX® Deep Sockets TORX® Steckschlüssel, lang Douilles longues TORX®



## RS3325/9 Socket Set on Rail Steckschlüsselsatz auf Schiene Jeu de douilles sur rail



## TORX® (E)

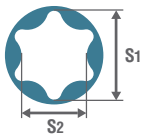

E	E4	E5	E6	E7	E8	E10	E11	E12	E14	E16	E18	E20	E22	E24	E26	E28	E30	E32
S <sub>1</sub> (ref. mm)	3.7	4.6	5.6	6.1	7.4	9.3	9.9	11.0	12.8	14.6	16.5	18.3	20.1	22.0	23.7	25.5	27.3	29.0
S <sub>2</sub> (ref. mm)	2.7	3.3	4.0	4.3	5.3	6.8	7.1	7.9	9.2	10.5	11.9	13.2	14.8	15.7	17.5	18.3	20.0	21.3

3350M (mm)	D <sub>1</sub> (mm)	D <sub>2</sub> (mm)	H <sub>1</sub> (mm)	H <sub>2</sub> (mm)	L (mm)	(g)	(pcs.)
8	12	17.4	5	41.5	55	50	10
10	14.5	17.4	6	41.5	55	54	10
12	16.8	17.2	7	41.5	55	58	10
13	18	17	8	41.5	55	59	10
14	19.5	18.5	8.5	41.5	55	71	10



RS3350M/5	5 Pieces set/Rail 150mm	(g)
8, 10, 12, 13, 14		322

## 3350M Nut Grip Deep Sockets Nut Grip® Steckschlüssel mit 2-facher Kugelhalterung, lang Douilles longues à billes de retenue



## RS3350M/5 Socket Set on Rail Steckschlüsselsatz auf Schiene Jeu de douilles sur rail



3300FN (mm)	D <sub>1</sub> (mm)	D <sub>2</sub> (mm)	H (mm)	L (mm)	S (mm)	(g)	(pcs.)
8	14.5	17.3	6	53	6.4	38	10
9	16	17.3	7	53	6.8	41	10
10	16.8	17.2	7.5	53	7.2	42	10
11	18	17	8.5	53	8.3	42	10
12	20	18	9	53	8.8	50	10
13	21.1	20	9.5	62	9.4	66	10
14	22	20	10.5	62	10.5	66	10
15	23	22	11	70	11.5	82	10
16	24	23	11.5	70	12	90	10
17	25	24	12.5	80	13	110	10
18	27	25	13	80	13.5	120	10
19	28	26	14	80	14.5	130	10
22	32	29.5	16	80	16	180	10
24	34.5	31.5	17	80	17	200	10

RS3300FN/8	8 Pieces Set/Rail 200mm	(g)
9, 10, 11, 13, 14, 16, 17, 19		600

## 3300FN Flare Nut Sockets Geschlitzte Steckschlüssel für Überwurfmuttern Douilles à tuyauter



## RS3300FN/8 Socket Set on Rail Steckschlüsselsatz auf Schiene Jeu de douilles sur rail



Z-SERIES  
HAND  
TITANIUM  
SCREWDRIVERS ACCESSORIES  
IMPACT  
SLEEVE-DRIVE  
PROTECTOR  
INDUSTRIAL  
AUTOMOTIVE  
MOTORCYCLE  
CONSTRUCTION  
MOTORCYCLE  
SPARE PART

### 3300M (L120)

6-point Extra Deep Sockets  
6-kant Steckschlüssel,extra lang  
Douilles extra longues 6-pans

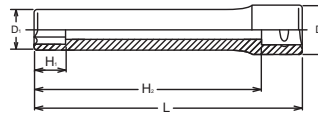

3300M-Size DEEP SOCKET

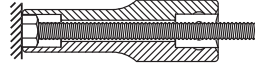

3300M-Size(L120) EXTRA DEEP SOCKET

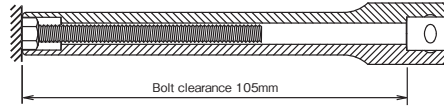

### 3305M (L120)

12-point Extra Deep Sockets  
12-kant Steckschlüssel,extra lang  
Douilles extra longues 12-pans



3300M(L120) 3305M(L120) (mm)	D <sub>1</sub> (mm)	D <sub>2</sub> (mm)	H <sub>1</sub> (mm)	H <sub>2</sub> (mm)	L (mm)	(g)	(pcs.)
8	12	17.3	9	106.5	120	85	10
10	14.5	17.3	11	106.5	120	110	10
12	16.8	17.2	13	106.5	120	116	10
13	18	17	14	106.5	120	155	5
14	20	18	16	106.5	120	166	5

### 3300M/4-L120 3305M/4-L120

Socket Set  
Steckschlüssel Satz  
Jeu de clés à douille



3300M/4-L120 4 Pieces Set/△=477g

PLASTIC BAG

Sockets

3300M(L120) 6-point Extra Deep Sockets  
8, 10, 12, 14

3305M/4-L120 4 Pieces Set/△=477g

PLASTIC BAG

Sockets

3305M(L120) 12-point Extra Deep Sockets  
8, 10, 12, 14

### 3350M (L120)

Nut Grip Deep Sockets **Nut Grip**<sup>®</sup>  
Steckschlüssel mit 2-facher Kugelhalterung, lang  
Douilles à billes de retenue

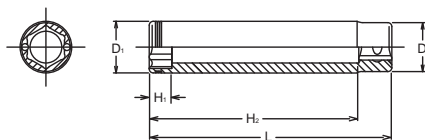

3350M(L120) (mm)	D <sub>1</sub> (mm)	D <sub>2</sub> (mm)	H <sub>1</sub> (mm)	H <sub>2</sub> (mm)	L (mm)	(g)	(pcs.)
10	14.5	17.2	6	106.5	120	110	10
12	16.8	17.2	7	106.5	120	116	10



NUT GRIP<sup>®</sup>

### 3350M/2-L120

Socket Set  
Steckschlüssel Satz  
Jeu de clés à douille



3350M/2-L120 2 Pieces Set/△=230g

PLASTIC BAG

Sockets

3350M(L120) Nut Grip Extra Deep Sockets  
10, 12

# 3/8"

Hand Sockets  
Hand Steckschlüssel  
Douilles à main

3440M 3445M (mm)	D <sub>1</sub> (mm)	D <sub>2</sub> (mm)	H (mm)	L (mm)	(g)	(pcs.)
8	12	19	7.3	47	50	10
9	13.3	19	7.8	47.5	50	10
10	14.5	19	8.8	48.5	64	10
11	15.8	19	9.8	49.5	66	10
12	17	19	10.3	50	67	10
13	18.3	19	11.3	51	68	10
14	19.5	19	11.3	51	69	10
15	20.8	19	12.8	53.5	70	10
16	22	19	12.8	53.5	77	10
17	23.3	19	13.8	54.5	80	10
18	24.5	19	13.8	54.5	80	10
19	25.8	19	15.8	56.5	84	10
21	28.3	19	16.8	56.5	96	10

## 3440M / 3440A

6-point Universal Sockets  
6-kant Gelenk-Einsätze  
Douilles articulées, 6-pans

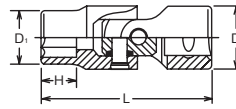

3440A 3445A (inch)	D <sub>1</sub> (mm)	D <sub>2</sub> (mm)	H (mm)	L (mm)	(g)	(pcs.)
5/16	12	19	7.3	47	50	10
3/8	14	19	8.3	48	64	10
7/16	15.8	19	9.8	49.5	66	10
1/2	18.3	19	11.3	51	68	10
9/16	19.5	19	11.3	51	69	10
5/8	22	19	12.8	53.5	77	10
11/16	24.5	19	13.8	54.5	80	10
3/4	25.8	19	15.8	56.5	84	10

## 3445M / 3445A

12-point Universal Sockets  
12-kant Gelenk-Einsätze  
Douilles articulées, 12-pans

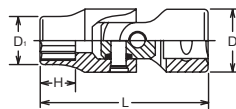

RS3440M/8	8 Pieces Set/Rail 200mm	(g)
8, 10, 11, 12, 13, 14, 17, 19		550

RS3440A/8	8 Pieces Set/Rail 200mm	(g)
5/16, 3/8, 7/16, 1/2, 9/16, 5/8, 11/16, 3/4		570

## RS3440M/8 RS3440A/8

Socket Set on Rail  
Steckschlüsselsatz auf Schiene  
Jeu de douilles sur rail



3445W (W)	D <sub>1</sub> (mm)	D <sub>2</sub> (mm)	H (mm)	L (mm)	(g)	(pcs.)
1/8	13.3	19	7.8	47.5	50	10
3/16	15.8	19	9.7	49.5	66	10
1/4	18.3	19	11.3	51	68	10
5/16	20.8	19	12.8	53.5	70	10
3/8	24.5	19	13.8	54.5	80	10
7/16	28.3	19	16.8	57.5	96	10
1/2	30.8	19	17.8	58.5	105	10

## 3445W

12-Point Whitworth Universal Socket  
12-kant Gelenk-Einsatz, Whitworth  
Douille articulées, 12-pans, Whitworth

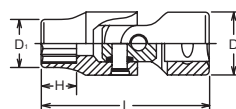

RS3445W/7	7 Pieces Set/Rail 200mm	(g)
1/8, 3/16, 1/4, 5/16, 3/8, 7/16, 1/2		570

## RS3445W/7

Socket Set on Rail  
Steckschlüsselsatz auf Schiene  
Jeu de douilles sur rail



Z-SERIES  
HAND  
TITANIUM  
ACCESSORIES  
SCREWDRIVERS  
IMPACT  
SLEEVE-DRIVE  
PROTECTOR  
INDUSTRIAL  
AUTOMOTIVE  
MOTORCYCLE  
CONSTRUCTION  
SPARE PART

Z-SERIES  
HAND  
TITANIUM  
SCREWDRIVERS  
ACCESSORIES  
IMPACT  
SLEEVE-DRIVE  
PROTECTOR  
INDUSTRIAL  
AUTOMOTIVE  
MOTORCYCLE  
CONSTRUCTION  
SPARE PART

### 3440T

 TORX® Universal Sockets  
TORX® Gelenk-Einsätze  
Douilles articulées TORX®

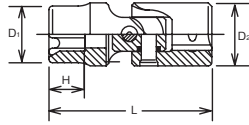

3440T (E)	D <sub>1</sub> (mm)	D <sub>2</sub> (mm)	H (mm)	L (mm)	(g)	(pcs.)
E 6	7.9	19	5.4	44.9	60	10
E 8	9.9	19	7	46.5	63	10
E10	11.8	19	8.2	47.7	63	10
E12	14.5	19	9.3	48.8	68	10
E14	15.7	19	10.6	50.1	68	10
E16	18	19	11.8	51.3	70	10
E18	19.5	19	13	53.5	78	10
E20	22	19	14.4	54.9	81	10

### RS3440T/8

 Socket Set on Rail  
Steckschlüsselsatz auf Schiene  
Jeu de douilles sur rail



RS3440T/8	8 Pieces Set/Rail 200mm	(g)
<b>E6, E8, E10, E12, E14, E16, E18, E20</b>		<b>594</b>

### 3441M

 Nut Grip Universal Sockets **Nut Grip®**  
Gelenk-Einsätze mit zweifacher Kugelhalterung  
Douilles articulées, à billes de retenue

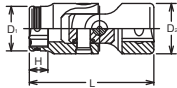

3441M (mm)	D <sub>1</sub> (mm)	D <sub>2</sub> (mm)	H (mm)	L (mm)	(g)	(pcs.)
8	12	19	5	46	57	10
10	14.5	19	6	46	58	10
12	16.8	19	7	47	58	10
13	18	19	8	48	60	10
14	19.5	19	8.5	49.5	65	10



### RS3441M/5

 Socket Set on Rail  
Steckschlüsselsatz auf Schiene  
Jeu de douilles sur rail



RS3441M/5	5 Pieces Set/Rail 150mm	(g)
<b>8, 10, 12, 13, 14</b>		<b>320</b>

### 3340M-75

 Universal Deep Sockets  
Gelenk-Steckschlüssel, lange Ausführung  
Douilles articulées longues

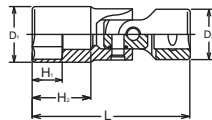

3340M-75 (mm)	D <sub>1</sub> (mm)	D <sub>2</sub> (mm)	H <sub>1</sub> (mm)	H <sub>2</sub> (mm)	L (mm)	(g)	(pcs.)
8	12	19	9	39	75	82	10
10	14.5	19	11	39	75	87	10
11	15.8	19	12	39	75	87	10
12	17	19	13	39	75	92	10
13	18.3	19	14	36	75	93	10
14	19.5	19	15	35	75	103	10
15	20.8	19	16	35	75	104	10
16	22	19	17	34	75	110	10
17	23.3	19	18	34	75	115	10
18	24.5	19	19	34	75	119	10
19	25.8	19	20	33	75	123	10

### RS3340M/8-L75

 Socket Set on Rail  
Steckschlüsselsatz auf Schiene  
Jeu de douilles sur rail



RS3340M/8-L75	8 Pieces Set/Rail 200mm	(g)
<b>8, 10, 11, 12, 13, 14, 17, 19</b>		<b>810</b>

3430M (mm)	D (mm)	H (mm)	L (mm)	(g)	(pcs.)
5	19	15.5	62	66	10
6	19	15.5	62	70	10
7	19	15.5	62	72	10
8	19	15.5	62	74	10
10	19	15.5	62	78	10
12	19	15.5	62	85	10

## 3430M Universal Hex Sockets Gelenk-Einsätze für Schrauben mit Innensechskant Douilles articulées, 6-pans mâle

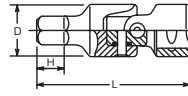

RS3430M/6	6 Pieces Set/Rail 150mm	(g)
5, 6, 7, 8, 10, 12		470

## RS3430M/6 Socket Set on Rail Steckschlüsselsatz auf Schiene Jeu de douilles sur rail



## 3117M-125 / -250 Extended Sockets Schaftsteckschlüssel Douilles rallongées

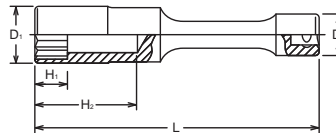

3117M-125 (mm)	D <sub>1</sub> (mm)	D <sub>2</sub> (mm)	H <sub>1</sub> (mm)	H <sub>2</sub> (mm)	L (mm)	(g)	(pce.)
10	14.5	18	10	44	125	121	1
11	16	18	11	44	125	133	1
12	17	18	12	44	125	133	1
13	18	18	13	44	125	134	1
14	19.5	18	14	44	125	145	1
17	23.5	18	17	44	125	178	1
19	25	18	19	44	125	187	1
21	27	18	21	44	125	195	1
22	29	18	22	44	125	214	1



3117M-250 (mm)	D <sub>1</sub> (mm)	D <sub>2</sub> (mm)	H <sub>1</sub> (mm)	H <sub>2</sub> (mm)	L (mm)	(g)	(pce.)
10	14.5	18	10	44	250	233	1
11	16	18	11	44	250	241	1
12	17	18	12	44	250	246	1
13	18	18	13	44	250	249	1
14	19.5	18	14	44	250	262	1
17	23.5	18	17	44	250	289	1
19	25	18	19	44	250	298	1
21	27	18	21	44	250	302	1
22	29	18	22	44	250	325	1

Z-SERIES  
HAND  
TITANIUM  
SCREWDRIVERS ACCESSORIES  
IMPACT  
SLEEVE-DRIVE  
PROTECTOR  
INDUSTRIAL  
AUTOMOTIVE  
MOTORCYCLE  
CONSTRUCTION  
SPARE PART

## 3000-60 (PH)

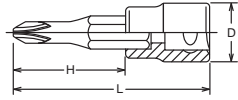
 Phillips Bit Sockets  
Steckschlüssel für Kreuzschlitzschrauben, Phillips  
Douilles tournevis pour vis à empreinte Phillips





3000 (PH)	D (mm)	H (mm)	L (mm)	 (g)	 (pcs.)
1	18	33.5	60	49	10
2	18	33.5	60	49	10
3	18	33.5	60	49	10
4	18	33.5	60	50	10

## 3000-50 (PZ)

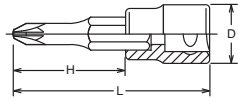
 PZ Bit Sockets  
Steckschlüssel für Kreuzschlitzschrauben, PZ  
Douilles tournevis pour vis à empreinte PZ









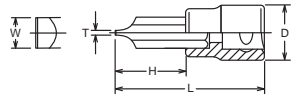







3000-50 (PZ)	D (mm)	H (mm)	L (mm)	 (g)	 (pcs.)
PZ1	18	23.5	50	50	10
PZ2	18	23.5	50	50	10
PZ3	18	23.5	50	50	10

## 3005-60

 Bit Sockets for Slotted Heads  
Steckschlüssel für Schlitzschrauben  
Douilles tournevis pour vis à fente





3005	TxW (mm)	D (mm)	H (mm)	L (mm)	 (g)	 (pcs.)
5	1.0x 5.5	18	33.5	60	47	10
8	1.2x 8	18	33.5	60	49	10
10	1.6x10	20	33.5	60	85	10

	 Phillips (PH)	 PZ	 Slotted	 HEX	 HEX (ball point)	 Triple Square (XZN)	 TORX® (T)	 TORX® (TH)	 TORXPLUS® (IP)	 TORXPLUS® (IPR)	 Ribe-CV
1/4"	No.2000 series	No.2000(PZ) series	No.2005 series	No.2010M/A series	No.2011M series	No.2020 series	No.2025 series	No.2025(TH) series	No.2025(IP) series	No.2025(IPR) series	—
3/8"	No.3000 series	No.3000(PZ) series	No.3005 series	No.3010M/A No.3012M/A No.3015M series	No.3011M series	No.3020 series	No.3025 series	No.3025(TH) series	No.3025(IP) series	No.3025(IPR) series	No.3027 series
1/2"	No.4000 series	No.4000(PZ) series	No.4005 series	No.4010M/A No.4012M/A series	—	No.4020 series	No.4025 series	—	No.4025(IP) series	—	No.4027 series



## 3010M-38 / -62 / -100 / -160 3010A-50

 Inhex Bit Sockets  
Steckschlüssel für Innensechskant-Schrauben  
 Douilles tournevis pour vis 6-pans creux

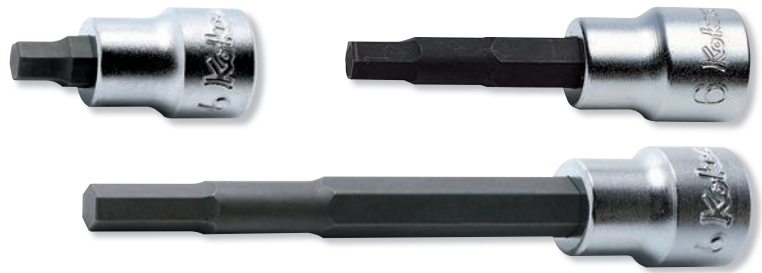
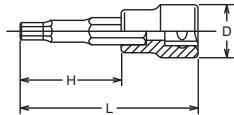

3010M-38 (mm)	D (mm)	H (mm)	L (mm)	(g)	(pcs.)
3	18	11.5	38	27	10
4	18	11.5	38	28	10
5	18	11.5	38	30	10
6	18	11.5	38	31	10
7	18	11.5	38	32	10
8	18	11.5	38	33	10
9	20	11.5	38	47	10
10	20	11.5	38	48	10
11	20	11.5	38	59	10
12	20	11.5	38	60	10
13	22	11.5	38	76	5
14	22	11.5	38	78	5

3010M-62 (mm)	D (mm)	H (mm)	L (mm)	(g)	(pcs.)
3	18	35.5	62	43	10
4	18	35.5	62	45	10
5	18	35.5	62	48	10
6	18	35.5	62	49	10
7	18	35.5	62	50	10
8	18	35.5	62	62	10
9	20	35.5	62	75	10
10	20	35.5	62	76	10
11	20	35.5	62	92	10
12	20	35.5	62	94	10
13	22	35.5	62	107	5
14	22	35.5	62	109	5

3010M-100 (mm)	D (mm)	H (mm)	L (mm)	(g)	(pcs.)
3	18	73.5	100	58	10
4	18	73.5	100	60	10
5	18	73.5	100	63	10
6	18	73.5	100	64	10
7	18	73.5	100	66	10
8	18	73.5	100	69	10
9	20	73.5	100	100	10
10	20	73.5	100	102	10
11	20	73.5	100	129	10
12	20	73.5	100	131	10
13	22	73.5	100	158	5
14	22	73.5	100	160	5

3010M-160 (mm)	D (mm)	H (mm)	L (mm)	(g)	(pcs.)
3	18	133.5	160	84	10
4	18	133.5	160	86	10
5	18	133.5	160	89	10
6	18	133.5	160	90	10
7	18	133.5	160	92	10
8	18	133.5	160	95	10
9	20	133.5	160	125	10
10	20	133.5	160	128	10
11	20	133.5	160	153	10
12	20	133.5	160	157	10
13	22	133.5	160	237	5
14	22	133.5	160	239	5

3010A-50 (inch)	D (mm)	H (mm)	L (mm)	(g)	(pcs.)
1/8	18	23.5	50	35	10
5/32	18	23.5	50	36	10
3/16	18	23.5	50	36	10
7/32	18	23.5	50	38	10
1/4	18	23.5	50	40	10
9/32	18	23.5	50	42	10
5/16	18	23.5	50	44	10
11/32	20	23.5	50	59	10
3/8	20	23.5	50	60	10
7/16	20	23.5	50	74	10
1/2	22	23.5	50	91	5

RS3010M/8-L38	8 Pieces Set/Rail 200mm	(g)
3, 4, 5, 6, 7, 8, 10, 12		322
RS3010M/8-L62	8 Pieces Set/Rail 200mm	(g)
3, 4, 5, 6, 7, 8, 10, 12		490
RS3010M/8-L100	8 Pieces Set/Rail 200mm	(g)
3, 4, 5, 6, 7, 8, 10, 12		645
RS3010A/8-L50	8 Pieces Set/Rail 200mm	(g)
1/8, 5/32, 3/16, 7/32, 1/4, 5/16, 3/8, 1/2		400

### RS3010M/8-L38



Socket Set on Rail  
Steckschlüsselsatz auf Schiene  
Jeu de douilles sur rail

### RS3010M/8-L62



### RS3010M/8-L100



### RS3010A/8-L50



Z-SERIES  
HAND  
TITANIUM  
ACCESSORIES  
SCREWDRIVERS  
IMPACT  
SLEEVE-DRIVE  
PROTECTOR  
INDUSTRIAL  
AUTOMOTIVE  
MOTORCYCLE  
CONSTRUCTION  
SPARE PART

## 3012M-25

 Inhex Sockets  
Steckschlüssel für Innensechskant-Schrauben  
Douilles tournevis pour vis 6-pans creux

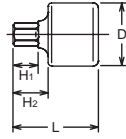

3012M-25 (mm)	D (mm)	H <sub>1</sub> (mm)	H <sub>2</sub> (mm)	L (mm)	(g)	(pcs.)
3	18.5	5.5	10	25	22	10
4	18.5	5.5	10	25	22	10
5	18.5	6.5	10	25	22	10
6	18.5	7.5	10	25	23	10
7	18.5	10	-	25	24	10
8	18.5	10	-	25	25	10
10	18.5	10	-	25	27	10
12	18.5	10	-	25	30	10
14	19	10	-	25	30	10
17	19	10	-	25	30	10

## 3012M-52 / -62 / -75 3012A-52 / -62 / -75

 Inhex Sockets  
Steckschlüssel für Innensechskant-Schrauben  
Douilles tournevis pour vis 6-pans creux



For Lubrication Service  
Schmierdienst-Werkzeuge  
Service lubrification-vidange

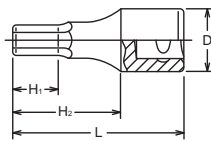

3012M/A are for hand use only.  
Do not use with a power or impact wrench.  
Bitte nicht auf Schlagschrauber oder anderen  
Maschinen gebrauchen.  
À ne pas utiliser sur des machines

3012M-52 (mm)	D (mm)	H <sub>1</sub> (mm)	H <sub>2</sub> (mm)	L (mm)	(g)	(pcs.)
3	18	10	34	52	35	10
4	18	15.5	34	52	38	10
5	18	15.5	34	52	40	10
6	18	15.5	34	52	42	10
7	18	15.5	34	52	46	10
8	18.5	15.5	34	52	50	10
9	18.5	15.5	34	52	55	10
10	20	15.5	34	52	66	10
11	20	15.5	34	52	72	10
12	20	15.5	34	52	77	10
13	20	15.5	34	52	82	10
14	20	15.5	34	52	89	10

3012M-62 (mm)	D (mm)	H <sub>1</sub> (mm)	H <sub>2</sub> (mm)	L (mm)	(g)	(pcs.)
3	18	10	44	62	38	10
4	18	15.5	44	62	40	10
5	18	15.5	44	62	43	10
6	18	15.5	44	62	46	10
7	18	15.5	44	62	53	10
8	18.5	15.5	44	62	58	10
9	18.5	15.5	44	62	63	10
10	20	15.5	44	62	77	10
11	20	15.5	44	62	83	10
12	20	15.5	44	62	90	10
13	20	15.5	44	62	95	10
14	20	15.5	44	62	109	10



3012M-75 (mm)	D (mm)	H <sub>1</sub> (mm)	H <sub>2</sub> (mm)	L (mm)	(g)	(pcs.)
3	18	10	57	75	41	10
4	18	15.5	57	75	43	10
5	18	15.5	57	75	48	10
6	18	15.5	57	75	53	10
7	18	15.5	57	75	58	10
8	18.5	15.5	57	75	72	10
9	18.5	15.5	57	75	92	10
10	20	15.5	57	75	114	10
11	20	15.5	57	75	120	10
12	20	15.5	57	75	127	10
13	20	15.5	57	75	132	10
14	20	15.5	57	75	146	10

3012A-52 (inch)	D (mm)	H <sub>1</sub> (mm)	H <sub>2</sub> (mm)	L (mm)	(g)	(pcs.)
1/8	18	10	34	52	35	10
5/32	18	15.5	34	52	38	10
3/16	18	15.5	34	52	40	10
7/32	18	15.5	34	52	42	10
1/4	18	15.5	34	52	44	10
9/32	18	15.5	34	52	46	10
5/16	18.5	15.5	34	52	50	10
11/32	18.5	15.5	34	52	55	10
3/8	20	15.5	34	52	65	10
7/16	20	15.5	34	52	72	10
1/2	20	15.5	34	52	82	10
9/16	20	15.5	34	52	89	10

3012A-62 (inch)	D (mm)	H <sub>1</sub> (mm)	H <sub>2</sub> (mm)	L (mm)	(g)	(pcs.)
1/8	18	10	44	62	38	10
5/32	18	15.5	44	62	40	10
3/16	18	15.5	44	62	43	10
7/32	18	15.5	44	62	46	10
1/4	18	15.5	44	62	48	10
9/32	18	15.5	44	62	53	10
5/16	18.5	15.5	44	62	58	10
11/32	18.5	15.5	44	62	63	10
3/8	20	15.5	44	62	73	10
7/16	20	15.5	44	62	83	10
1/2	20	15.5	44	62	95	10
9/16	20	15.5	44	62	109	10

3012A-75 (inch)	D (mm)	H <sub>1</sub> (mm)	H <sub>2</sub> (mm)	L (mm)	(g)	(pcs.)
1/8	18	10	57	75	41	10
5/32	18	15.5	57	75	43	10
3/16	18	15.5	57	75	48	10
7/32	18	15.5	57	75	53	10
1/4	18	15.5	57	75	58	10
9/32	18	15.5	57	75	72	10
5/16	18.5	15.5	57	75	92	10
11/32	18.5	15.5	57	75	114	10
3/8	20	15.5	57	75	120	10
7/16	20	15.5	57	75	127	10
1/2	20	15.5	57	75	132	10
9/16	20	15.5	57	75	146	10

## RS3012M/8-L52 RS3012A /8-L52

  Socket Set on Rail  
Steckschlüsselsatz auf Schiene  
Jeu de douilles sur rail



RS3012M/8-L52	8 Pieces Set/Rail 200mm	(g)
3, 4, 5, 6, 7, 8, 10, 12		394

RS3012A/8-L52	8 Pieces Set/Rail 200mm	(g)
1/8, 5/32, 3/16, 7/32, 1/4, 5/16, 3/8, 1/2		425

3011M-62 (mm)	D (mm)	H (mm)	L (mm)	(g)	(pcs.)
3	18	35.5	62	45	10
4	18	35.5	62	46	10
5	18	35.5	62	48	10
6	18	35.5	62	49	10
7	18	35.5	62	50	10
8	18	35.5	62	51	10
10	20	35.5	62	66	10
12	20	35.5	62	79	10

3011M-100 (mm)	D (mm)	H (mm)	L (mm)	(g)	(pcs.)
3	18	73.5	100	61	10
4	18	73.5	100	62	10
5	18	73.5	100	64	10
6	18	73.5	100	65	10
7	18	73.5	100	67	10
8	18	73.5	100	68	10

3011M-120 (mm)	D (mm)	H (mm)	L (mm)	(g)	(pcs.)
3	18	93.5	120	77	10
4	18	93.5	120	78	10
5	18	93.5	120	80	10
6	18	93.5	120	81	10
7	18	93.5	120	83	10
8	18	93.5	120	84	10

3011M-160 (mm)	D (mm)	H (mm)	L (mm)	(g)	(pcs.)
3	18	133.5	160	87	10
4	18	133.5	160	88	10
5	18	133.5	160	89	10
6	18	133.5	160	91	10
7	18	133.5	160	93	10
8	18	133.5	160	95	10

**!** Ball point bit sockets have less strength due to the special design. Make sure to use them correctly.

3015M-62 (mm)	D (mm)	H (mm)	L (mm)	(g)	(pcs.)
3	18	35.5	62	43	10
4	18	35.5	62	45	10
5	18	35.5	62	50	10
6	18	35.5	62	50	10
7	18	35.5	62	50	10
8	18	35.5	62	62	10
10	20	35.5	62	75	10
12	20	35.5	62	95	10

3015M-100 (mm)	D (mm)	H (mm)	L (mm)	(g)	(pcs.)
3	18	73.5	100	60	10
4	18	73.5	100	60	10
5	18	73.5	100	65	10
6	18	73.5	100	65	10
7	18	73.5	100	70	10
8	18	73.5	100	70	10
10	20	73.5	100	105	10
12	20	73.5	100	135	10

Grip Ring holds hex screws

**!** Grip Ring bit sockets have less strength due to the special design. Make sure to use them correctly.

RS3015M/8-L62	8 Pieces Set/Rail 200mm	(g)
3, 4, 5, 6, 7, 8, 10, 12		500

RS3015M/8-L100	8 Pieces Set/Rail 200mm	(g)
3, 4, 5, 6, 7, 8, 10, 12		650

## 3011M-62 / -100 / -120 / -160

**!** Ballpoint Inhex Sockets  
Steckschlüssel mit Kugelkopf, für Innensechskant-Schrauben  
Douilles tournevis avec tête sphérique pour vis 6-pans creux

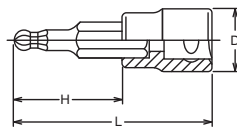

## 3015M-62 / -100

**!** Inhex Bit Socket, Grip Ring  
Steckschlüssel für Innensechskant-Schrauben  
Douilles tournevis pour vis 6-pans creux

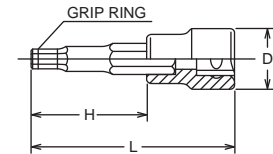

## RS3015M/8-L62

## RS3015M/8-L100

**!** Socket Set on Rail  
Steckschlüsselsatz auf Schiene  
Jeu de douilles sur rail



## 3020-38 / -50 / -100 / -120



XZN Bit Sockets  
Steckschlüssel für XZN Schrauben  
Douilles tournevis pour empreinte XZN

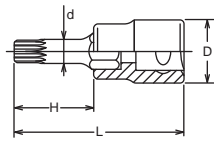

3020-38 (XZN)	D (mm)	d (mm)	H (mm)	L (mm)	(g)	(pcs.)
M 5	18	7.8	11.5	38	32	10
M 6	18	7.8	11.5	38	33	10
M 8	18	7.8	11.5	38	36	10
M10	20	11.9	11.5	38	51	10
M12	20	11.9	11.5	38	52	10
M14	22	13.9	11.5	38	74	10

3020-50 (XZN)	D (mm)	d (mm)	H (mm)	L (mm)	(g)	(pcs.)
M 4	18	7.8	23.5	50	35	10
M 5	18	7.8	23.5	50	37	10
M 6	18	7.8	23.5	50	39	10
M 8	18	7.8	23.5	50	40	10
M10	20	11.9	23.5	50	65	10
M12	20	11.9	23.5	50	69	10
M14	22	13.9	23.5	50	75	10

3020-100 (XZN)	D (mm)	d (mm)	H (mm)	L (mm)	(g)	(pcs.)
M 4	18	7.8	73.5	100	57	10
M 5	18	7.8	73.5	100	59	10
M 6	18	7.8	73.5	100	61	10
M 8	18	7.8	73.5	100	62	10
M10	20	11.9	73.5	100	99	10
M12	20	11.9	73.5	100	103	10
M14	22	13.9	73.5	100	145	5

3020-120 (XZN)	D (mm)	d (mm)	H (mm)	L (mm)	(g)	(pcs.)
M 4	18	7.8	93.5	120	77	10
M 5	18	7.8	93.5	120	79	10
M 6	18	7.8	93.5	120	81	10
M 8	18	7.8	93.5	120	82	10
M10	20	11.9	93.5	120	119	10
M12	20	11.9	93.5	120	123	10
M14	22	13.9	93.5	120	165	5

## RS3020/6-L38



Socket Set on Rail  
Steckschlüsselsatz auf Schiene  
Jeu de douilles sur rail



RS3020/6-L38	6 Pieces Set/Rail 150mm	(g)
M5, M6, M8, M10, M12, M14		308

## RS3020/7-L50



Socket Set on Rail  
Steckschlüsselsatz auf Schiene  
Jeu de douilles sur rail



RS3020/7-L50	7 Pieces Set/Rail 200mm	(g)
M4, M5, M6, M8, M10, M12, M14		400

### XZN

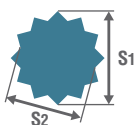

XZN		M4	M5	M6	M8	M10	M12	M14	M16	M18
S <sub>1</sub>	(ref. mm)	3.6	4.8	6.1	7.3	9.7	11.5	13.3	15.7	16.9
S <sub>2</sub>	(ref. mm)	3.1	4.1	5.1	6.1	8.1	9.7	11.2	13.2	14.2

# 3/8"

Hand Sockets  
Hand Steckschlüssel  
Douilles à main

3025-38 (T)	D (mm)	H (mm)	L (mm)	(g)	(pcs.)
T 8	18	11.5	38	32	10
T 9	18	11.5	38	32	10
T10	18	11.5	38	32	10
T15	18	11.5	38	33	10
T20	18	11.5	38	33	10
T25	18	11.5	38	33	10
T27	18	11.5	38	33	10
T30	18	11.5	38	33	10
T40	18	11.5	38	34	10
T45	18	11.5	38	37	10
T50	20	11.5	38	49	10
T55	20	11.5	38	57	10

3025-50 (T)	D (mm)	H (mm)	L (mm)	(g)	(pcs.)
T 8	18	23.5	50	36	10
T 9	18	23.5	50	36	10
T10	18	23.5	50	36	10
T15	18	23.5	50	36	10
T20	18	23.5	50	36	10
T25	18	23.5	50	37	10
T27	18	23.5	50	37	10
T30	18	23.5	50	38	10
T40	18	23.5	50	39	10
T45	18	23.5	50	41	10
T50	20	23.5	50	55	10
T55	20	23.5	50	67	10

RS3025/8-L38	8 Pieces Set/Rail 200mm	(g)
T10, T15, T20, T25, T27, T30, T40, T45		300

RS3025/8-L50	8 Pieces Set/Rail 200mm	(g)
T10, T15, T20, T25, T27, T30, T40, T45		320

## 3025-38 / -50 / -140 (T)

TORX® Bit Sockets  
TORX® Bit-Steckschlüssel  
Douilles tournevis, TORX®

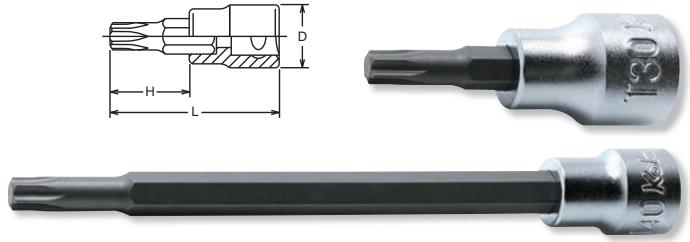

3025-140 (T)	D (mm)	H (mm)	L (mm)	(g)	(pcs.)
T 9	18	113.5	140	75	10
T10	18	113.5	140	75	10
T15	18	113.5	140	75	10
T20	18	113.5	140	75	10
T25	18	113.5	140	76	10
T27	18	113.5	140	76	10
T30	18	113.5	140	77	10
T40	18	113.5	140	78	10
T45	18	113.5	140	80	10
T50	20	113.5	140	94	10
T55	20	113.5	140	106	10

## RS3025/8-L38 RS3025/8-L50

Socket Set on Rail  
Steckschlüsselsatz auf Schiene  
Jeu de douilles sur rail



TORX®  
(T)

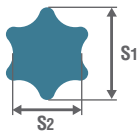

T	T8	T9	T10	T15	T20	T25	T27	T30	T40	T45	T50	T55	T60	T70	T80	T90	T100
S <sub>1</sub> (ref. mm)	2.3	2.5	2.7	3.3	3.9	4.5	5.0	5.6	6.7	7.9	8.9	11.3	13.3	15.6	17.6	20.0	22.2
S <sub>2</sub> (ref. mm)	1.7	1.8	2.0	2.3	2.8	3.2	3.6	4.0	4.8	5.6	6.2	8.0	9.5	11.1	12.7	14.2	15.8

3025-50	D (mm)	H (mm)	L (mm)	(g)	(pcs.)
T35	18	23.5	50	39	10

3025-100R (T)	D (mm)	d (mm)	H (mm)	L (mm)	(g)	(pcs.)
T20	18	4	73.5	100	38	10
T25	18	4.6	73.5	100	40	10
T27	18	5.2	73.5	100	42	10
T30	18	5.7	73.5	100	45	10
T40	18	6.8	73.5	100	52	10
T45	18	8	73.5	100	73	10
T50	20	9	73.5	100	80	10
T55	20	11.4	73.5	100	106	10

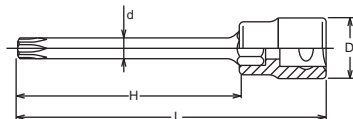

RS3025/8-L100R	8 Pieces Set/Rail 200mm	(g)
T20, T25, T27, T30, T40, T45, T50, T55		490

## 3025-50-T35

Bit Socket  
Bit-Steckschlüssel  
Douilles tournevis



## 3025-100R (T)

TORX® Bit Sockets, round-shaft  
TORX® Bit-Steckschlüssel mit Rundschaft  
Douilles tournevis TORX® avec manche ronde



## RS3025/8-L100R

Socket Set on Rail  
Steckschlüsselsatz auf Schiene  
Jeu de douilles sur rail



Z-SERIES  
HAND  
TITANIUM  
SCREWDRIVERS ACCESSORIES  
IMPACT  
SLEEVE-DRIVE  
PROTECTOR  
INDUSTRIAL  
AUTOMOTIVE  
CONSTRUCTION MOTORCYCLE  
SPARE PART

## 3025-50 / -160 (TH)

 Tamper Resistant TORX® Bit Sockets  
Tamper Resistant TORX® Bit-Steckschlüssel  
Douilles tournevis, Tamper-Resistant TORX®



 Tamper Resistant TORX® Bit Sockets have less strength due to special design. Make sure to use it correctly.



Bitte beachten Sie die geringere Belastbarkeit der Tamper Resistant Torx Steckschlüssel.

Veuillez respecter la moindre capacité inférieure de charge des douilles Tamper Resistant Torx.

3025-50 (TH)	D (mm)	H (mm)	L (mm)	(g)	(pcs.)
T10H	18	23.5	50	37	10
T15H	18	23.5	50	38	10
T20H	18	23.5	50	38	10
T25H	18	23.5	50	38	10
T27H	18	23.5	50	38	10
T30H	18	23.5	50	39	10
T40H	18	23.5	50	40	10
T45H	18	23.5	50	41	10
T50H	20	23.5	50	61	10
T55H	20	23.5	50	61	10

3025-160 (TH)	D (mm)	H (mm)	L (mm)	(g)	(pcs.)
T25H	18	133.5	160	83	10
T27H	18	133.5	160	83	10
T30H	18	133.5	160	84	10
T40H	18	133.5	160	85	10
T45H	18	133.5	160	86	10
T50H	20	133.5	160	128	10
T55H	20	133.5	160	128	10

## RS3025/9-HOLE

  Socket Set on Rail  
Steckschlüsselsatz auf Schiene  
Jeu de douilles sur rail



RS3025/9-HOLE	9 Pieces Set/Rail 200mm	(g)
T10H, T15H, T20H, T25H, T27H, T30H, T40H, T45H, T50H		405

## 3247

 Bit Socket Set  
Schraubendreher-Steckschlüssel Satz  
Jeu de douilles de vissage



3247	4 Pieces Set/ =385g
PLASTIC BAG	
Sockets	
 3025.160 Tamper-Resistant TORX® Bit Sockets	T27H, T30H, T40H, T50H

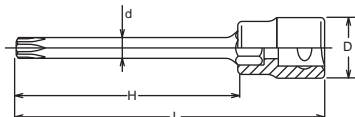

## 3025-100R (TH)

 Tamper-Resistant TORX® Bit Sockets, round-shaft  
Tamper-Resistant TORX® Bit-Steckschlüssel mit Rundschaft  
Douilles tournevis, Tamper-Resistant TORX® avec manche ronde



3025-100R (TH)	D (mm)	d (mm)	H (mm)	L (mm)	(g)	(pcs.)
T20H	18	4	73.5	100	38	10
T25H	18	4.6	73.5	100	40	10
T27H	18	5.2	73.5	100	42	10
T30H	18	5.7	73.5	100	45	10
T40H	18	6.8	73.5	100	52	10
T45H	18	8	73.5	100	73	10
T50H	20	9	73.5	100	80	10
T55H	20	11.4	73.5	100	106	10

## RS3025/8-L100RH

  Socket Set on Rail  
Steckschlüsselsatz auf Schiene  
Jeu de douilles sur rail



RS3025/8-L100RH	8 Pieces Set/Rail 200mm	(g)
T20H, T25H, T27H, T30H, T40H, T45H, T50H, T55H		490

Z-SERIES  
HAND  
TITANIUM  
ACCESSORIES  
SCREWDRIVERS  
IMPACT  
SLEEVE-DRIVE  
PROTECTOR  
INDUSTRIAL  
AUTOMOTIVE  
MOTORCYCLE  
CONSTRUCTION  
SPARE PART

3025-50 (IP)	D (mm)	H (mm)	L (mm)	(g)	(pcs.)
10IP	18	23.5	50	38	10
15IP	18	23.5	50	38	10
20IP	18	23.5	50	38	10
25IP	18	23.5	50	38	10
27IP	18	23.5	50	40	10
30IP	18	23.5	50	40	10
40IP	18	23.5	50	41	10
45IP	18	23.5	50	41	10
50IP	20	23.5	50	61	10
55IP	20	23.5	50	61	10

RS3025/8-IP	8 Pieces Set/Rail 200mm	(g)
20IP, 25IP, 27IP, 30IP, 40IP, 45IP, 50IP, 55IP		370

RSX025/11-IP	11 Pieces Set/Rail 200mm	(g)
2025.28(IP)	10IP, 15IP, 20IP, 25IP, 27IP	480
3025.50(IP)	30IP, 40IP, 45IP, 50IP	
4025.60(IP)	55IP, 60IP	

$1\frac{1}{4}" + 3\frac{3}{8}" + 1\frac{1}{2}"$

## 3025-50 (IP)



TORXPLUS® Bit Sockets  
TORXPLUS® Bit-Steckschlüssel  
Douilles tournevis, TORXPLUS®

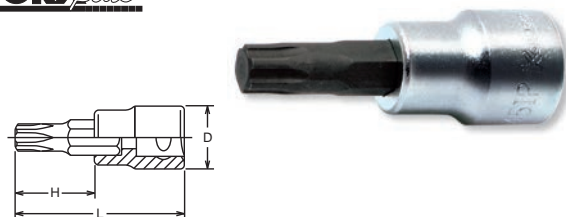

## RS3025/8-IP



Socket Set on Rail  
Steckschlüsselsatz auf Schiene  
Jeu de douilles sur rail



## RSX025/11-IP



Socket Set on Rail  
Steckschlüsselsatz auf Schiene  
Jeu de douilles sur rail



### TORXPLUS® (IP)

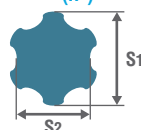

IP	8IP	9IP	10IP	15IP	20IP	25IP	27IP	30IP	40IP	45IP	50IP	55IP	60IP	70IP
S <sub>1</sub>	(ref. mm) 2.3	2.5	2.7	3.3	3.9	4.5	5.0	5.6	6.7	7.9	8.9	11.3	13.3	15.6
S <sub>2</sub>	(ref. mm) 1.7	1.8	2.0	2.3	2.8	3.2	3.6	4.0	4.8	5.6	6.2	8.0	9.5	11.1

# TORXplus®

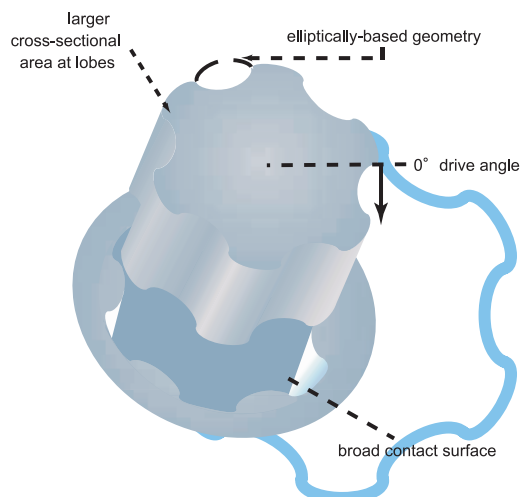
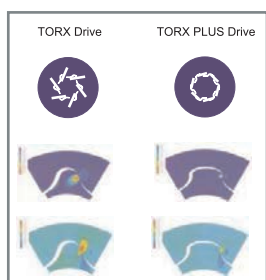
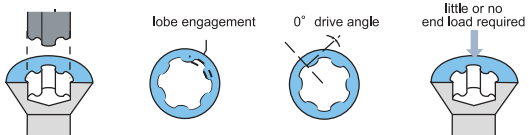

Z-SERIES  
HAND  
TITANIUM  
SCREWDRIVERS ACCESSORIES  
IMPACT  
SLEEVE-DRIVE  
PROTECTOR  
INDUSTRIAL  
AUTOMOTIVE  
CONSTRUCTION MOTORCYCLE  
SPARE PART

## 3025-50 (IPR)



TORXPLUS® Bit Sockets, with hole  
TORXPLUS® Bit-Steckschlüssel mit Stirnbohrung  
Douilles tournevis TORXPLUS® avec trou



3025-50 (IPR)	D (mm)	H (mm)	L (mm)	(g)	(pcs.)
10IPR	18	23.5	50	38	10
15IPR	18	23.5	50	38	10
20IPR	18	23.5	50	38	10
25IPR	18	23.5	50	38	10
27IPR	18	23.5	50	40	10
30IPR	18	23.5	50	40	10
40IPR	18	23.5	50	41	10
45IPR	18	23.5	50	41	10
50IPR	20	23.5	50	61	10
55IPR	20	23.5	50	61	10

## RS3025/9-IPR



Socket Set on Rail  
Steckschlüsselsatz auf Schiene  
Jeu de douilles sur rail



RS3025/9-IPR	9 Pieces Set/Rail 200mm	(g)
10IPR, 15IPR, 20IPR, 25IPR, 27IPR, 30IPR, 40IPR, 45IPR, 50IPR		395

## RSX025/11-IPR



Socket Set on Rail  
Steckschlüsselsatz auf Schiene  
Jeu de douilles sur rail



RSX025/11-IPR	11 Pieces Set/Rail 200mm	(g)
2025.28(IPR)	8IPR, 10IPR, 15IPR, 20IPR, 25IPR, 27IPR, 30IPR	320
3025.50(IPR)	40IPR, 45IPR, 50IPR, 55IPR	

1/4" + 3/8"

### TORXPLUS® (IPR)

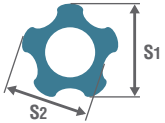

IPR	8IPR	9IPR	10IPR	15IPR	20IPR	25IPR	27IPR	30IPR	40IPR	45IPR	50IPR	55IPR
S <sub>1</sub> (ref. mm)	2.2	2.4	2.6	3.1	3.6	4.1	4.7	5.2	6.3	7.4	8.4	10.6
S <sub>2</sub> (ref. mm)	2.0	2.2	2.4	2.8	3.3	3.8	4.3	4.8	5.7	6.7	7.6	9.7

## 3027-50 / -100



Bit Sockets for Ribe Screws  
Steckschlüsselklingen für Ribe Schrauben  
Douilles tournevis pour écrous profil Ribe

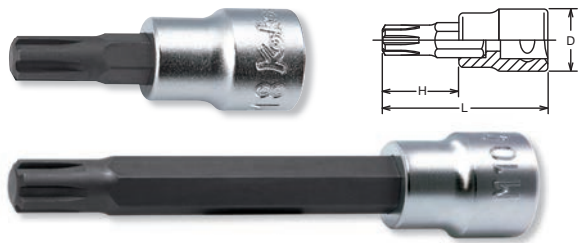

3027-50	D (mm)	H (mm)	L (mm)	(g)	(pcs.)
M 5	18	23.5	50	38	10
M 6	18	23.5	50	38	10
M 7	18	23.5	50	38	10
M 8	18	23.5	50	39	10
M 9	20	23.5	50	40	10
M10	20	23.5	50	40	10
M12	20	23.5	50	41	10

3027-100	D (mm)	H (mm)	L (mm)	(g)	(pcs.)
M 5	18	73.5	100	40	10
M 6	18	73.5	100	42	10
M 8	18	73.5	100	45	10
M10	20	73.5	100	52	10
M12	20	73.5	100	73	10

## RS3027/5-L50



Socket Set on Rail  
Steckschlüsselsatz auf Schiene  
Jeu de douilles sur rail



RS3027/5-L50	5 Pieces Set/Rail 150mm	(g)
M5, M6, M8, M10, M12		240

### Ribe CV

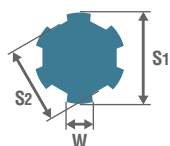

CV	M5	M6	M7	M8	M9	M10	M12	M13	M14	M16
W (ref. mm)	1.2	1.3	1.4	1.8	2.0	2.3	2.6	3.1	3.2	3.6
S <sub>1</sub> (ref. mm)	5.0	6.0	7.0	8.0	9.0	10.0	12.0	13.0	14.0	16.0
S <sub>2</sub> (ref. mm)	3.8	4.5	5.0	6.0	7.1	7.4	9.0	11.0	10.4	11.9



3110M (mm)	D (mm)	H (mm)	L (mm)	(g)	(pcs.)
6	18	10	28	30	10
8	18	10	28	30	10
10	18	10	28	33	10
12	18	10	28	37	10

3110A (inch)	D (mm)	H (mm)	L (mm)	(g)	(pcs.)
5/16	18	10	28	30	10
3/8	18	10	28	33	10
1/2	18	10	28	37	10

## 3110M / 3110A

4-point Male Sockets  
Öldienst-Steckschlüssel  
Douilles mâles 4-pans

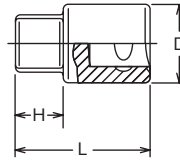

3119 (mm)	T <sub>1</sub> x T <sub>2</sub> (mm)	D <sub>1</sub> (mm)	D <sub>2</sub> (mm)	d (mm)	L (mm)	(g)	(pcs.)
3 x 5	3 x 5	17	17.3	11	30	30	10
5.5 x 6	5.5 x 6	21	19.5	14	33	45	10



For Wing Bolt  
Für Flügelschrauben  
Pour écrous à oreilles

For Drain Plug in Radiator  
Für Kühler-Ablasschrauben  
Pour le vidange du radiateur

## 3119

Wing Bolt Socket  
Steckschlüssel für Flügelschrauben  
Douilles pour écrous à oreilles

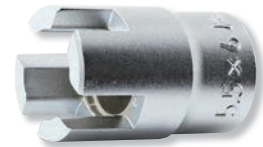
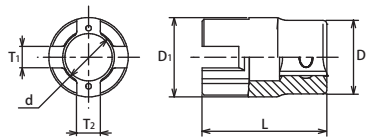

3137	D <sub>1</sub> (mm)	D <sub>2</sub> (mm)	L (mm)	(g)	(pcs.)
3137	13	16.5	30	30	10

For DIN3126 C6.3 Bits  
Für DIN3126 C6.3 Bits  
Pour DIN3126 C6.3 Embouts

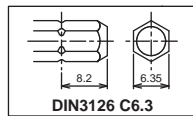

## 3137

Bit Holder  
Klingenhalter  
Porte-embouts

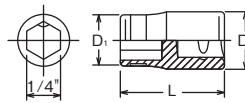

3138	D <sub>1</sub> (mm)	D <sub>2</sub> (mm)	L (mm)	(g)	(pcs.)
3138	16	18	38	55	10

For DIN3126 C8 Bits  
Für DIN3126 C8 Bits  
Pour DIN3126 C8 Embouts

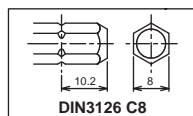

## 3138

Bit Holder  
Klingenhalter  
Porte-embouts

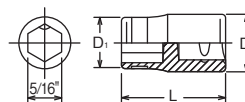

Z-SERIES  
HAND  
TITANIUM  
SCREWDRIVERS ACCESSORIES  
IMPACT  
SLEEVE-DRIVE  
PROTECTOR  
INDUSTRIAL  
AUTOMOTIVE  
MOTORCYCLE  
CONSTRUCTION  
SPARE PART

## 2749PS-3/8

Reversible Ratchet (Short)  
Knarre kurz, verstellbar  
Cliquet courte, réversible

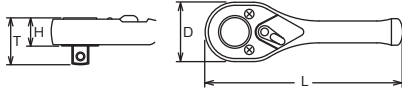

\* Renewal Kits → 2749RK-3/8 → P304

	D (mm)	T (mm)	H (mm)	L (mm)	(g)	(pcs.)
2749PS-3/8	25	21.9	11.2	75	70	10

## 2749P-3/8

Reversible Ratchet  
Knarre, verstellbar  
Cliquet, réversible

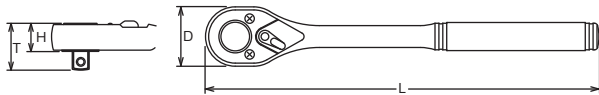

\* Renewal Kits → 2749RK-3/8 → P304

	D (mm)	T (mm)	H (mm)	L (mm)	(g)	(pcs.)
2749P-3/8	25	21.9	11.2	125	101	10

2749-3/8 series have less strength compared with normal [38] ratchet due to the technical design. Make sure to use the ratchet correctly.

## 3749S

Reversible Ratchet (Short)  
Knarre kurz, verstellbar  
Cliquet courte, réversible



\* Renewal Kits → 3749RK → P304

## 3749SB

Reversible Ratchet with quick release button  
Knarre, verstellbar mit Entriegelungsknopf  
Cliquet, réversible avec bouton de débrayage

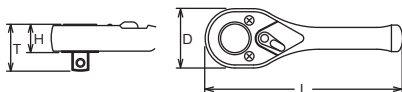

\* Renewal Kits → 3749BRK → P304

	D (mm)	T (mm)	H (mm)	L (mm)	(g)	(pcs.)
3749S	34	24.8	14.1	110	183	5
3749SB	34	24.8	14.1	110	183	5

Reversible Ratchet with quick release button has less strength compared with normal ratchet due to the technical design. Make sure to use the ratchet correctly.

## 3753SM

Multi Purpose Ratchet, reversible  
Knarre mit 2 Vierkantöffnungen, umstellbar  
Cliquet réversible deux carrés femelles, réversibles

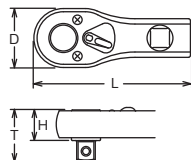

\* Renewal Kits → 3753RK → P304

	D (mm)	T (mm)	H (mm)	L (mm)	(g)	(pcs.)
3753SM	30.5	26.4	15.7	81	175	5

## 3753SMB

Multi Purpose Ratchet, reversible, with quick release button  
Knarre mit 2 Vierkantöffnungen, mit Entriegelungsknopf umstellbar  
Cliquet réversible deux carrés, avec bouton de débrayage

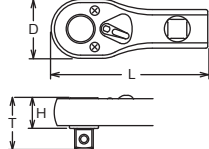

\* Renewal Kits → 3753BRK → P304

	D (mm)	T (mm)	H (mm)	L (mm)	(g)	(pcs.)
3753SMB	30.5	26.4	15.7	81	175	5



## [L/R Marking]



\* Renewal Kits → 3752RK → P305



\* Renewal Kits → 3752RK → P305

A pointer and L/R markings on the ratchet head indicate the turning direction. The reduced diameter of the head allows easier access in tight spots.

Eine L/R Markierung auf dem Knarrenkopf zeigt die gerade eingestellte Drehrichtung an. Der geringe Kopfdurchmesser erleichtert das Arbeiten auch an schwer zugänglichen Stellen.

Un marquage L/R sur la tête de cliquet indique le sens de rotation. Le diamètre de tête réduit facilite le travail dans les endroits difficilement accessibles.

	D (mm)	T (mm)	H (mm)	L (mm)	(g)	(pce.)
3752J	33	34.3	23.9	200	310	1
3752N	33	34.3	23.9	200	310	1



**3752J** Reversible Ratchet  
Knarre, verstellbar  
Cliquet, réversible



**3752N** Reversible Ratchet  
Knarre, verstellbar  
Cliquet, réversible

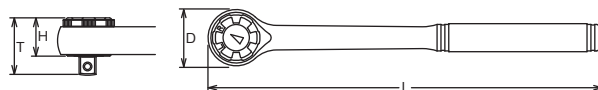

\* Renewal Kits → 3753RK → P304



\* Renewal Kits → 3753RK → P304



\* Renewal Kits → 3753RK → P304



\* Renewal Kits → 3753RK → P304

**3753J** Reversible Ratchet  
Knarre, verstellbar  
Cliquet, réversible



**3753P** Reversible Ratchet  
Knarre, verstellbar  
Cliquet, réversible



**3753N** Reversible Ratchet  
Knarre, verstellbar  
Cliquet, réversible



**D3753J** Reversible Ratchet  
Knarre, verstellbar  
Cliquet, réversible



	D (mm)	T (mm)	H (mm)	L (mm)	(g)	(pce.)
3753J	30.5	26.4	15.7	200	260	1
3753P	30.5	26.4	15.7	200	286	1
3753N	30.5	26.4	15.7	200	320	1
D3753J	30.5	26.4	15.7	200	260	1

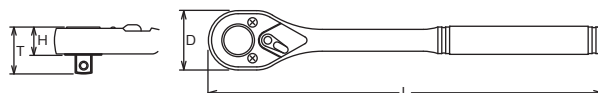

\* Renewal Kits → 3753RK → P304



**3753P-250** Reversible Ratchet (Long)  
Verstellbare Knarre, lang ⚠  
Cliquet réversible, long

	D (mm)	T (mm)	H (mm)	L (mm)	(g)	(pce.)
3753P-250	30.5	26.4	15.7	250	335	1

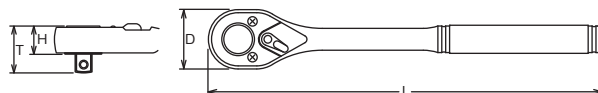

⚠ 3753P-250 have longer handle than standard, and can be loaded to excessive torque value. In the interest of your own safety always apply load evenly and progressively to avoid breakage and possible injury.

# Hand Sockets Hand Steckschlüssel Douilles à main

## 3/8"

Z-SERIES  
HAND  
TITANIUM  
SCREWDRIVERS ACCESSORIES  
IMPACT  
SLEEVE-DRIVE  
PROTECTOR  
INDUSTRIAL  
AUTOMOTIVE  
CONSTRUCTION MOTORCYCLE  
SPARE PART

**3753JB** Reversible Ratchet with quick release button  
Knarre, verstellbar mit Entriegelungsknopf  
Cliquet, réversible avec bouton de débrayage



\* Renewal Kits → 3753BRK → P304

**3753PB** Reversible Ratchet with quick release button  
Knarre, verstellbar mit Entriegelungsknopf  
Cliquet, réversible avec bouton de débrayage



\* Renewal Kits → 3753BRK → P304

**3753NB** Reversible Ratchet with quick release button  
Knarre, verstellbar mit Entriegelungsknopf  
Cliquet, réversible avec bouton de débrayage



\* Renewal Kits → 3753BRK → P304

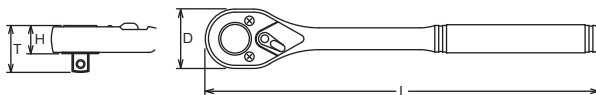

⚠ Reversible Ratchet with quick release button has less strength compared with normal ratchet due to the technical design. Make sure to use the ratchet correctly.

	D (mm)	T (mm)	H (mm)	L (mm)	(g)	(pcs.)
3753JB	30.5	26.4	15.7	200	260	1
3753PB	30.5	26.4	15.7	200	286	1
3753NB	30.5	26.4	15.7	200	320	1

**2774JS-3/8** Flexible Ratchet, reversible  
Gelenk-Knarre, verstellbar  
Cliquet articulé, réversible



\* Renewal Kits → 2749RK-3/8 → P304

**2774PS-3/8** Flexible Ratchet, reversible  
Gelenk-Knarre, verstellbar  
Cliquet articulé, réversible



\* Renewal Kits → 2749RK-3/8 → P304

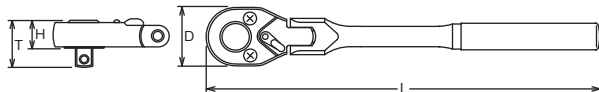

	D (mm)	T (mm)	H (mm)	L (mm)	(g)	(pcs.)
2774JS-3/8	25	21.9	11.2	120	113	5
2774PS-3/8	25	21.9	11.2	120	133	5

⚠ 2774-3/8 series have less strength compared with normal 387 ratchet due to the technical design. Make sure to use the ratchet correctly.

**3774PS** Flexible Ratchet, reversible  
Gelenk-Knarre, verstellbar  
Cliquet articulé, réversible



\* Renewal Kits → 3753RK → P304

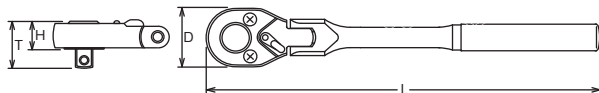

	D (mm)	T (mm)	H (mm)	L (mm)	(g)	(pcs.)
3774PS	30.5	26.4	15.7	175	250	2

# Hand Sockets Hand Steckschlüssel Douilles à main

Z-SERIES  
HAND  
TITANIUM  
ACCESSORIES  
SCREWDRIVERS  
IMPACT  
SLEEVE-DRIVE  
PROTECTOR  
INDUSTRIAL  
AUTOMOTIVE  
MOTORCYCLE  
CONSTRUCTION  
SPARE PART



\* Renewal Kits → 3753RK → P304

**3774J** Flexible Ratchet, reversible  
Gelenk-Knarre, verstellbar  
Cliquet articulé, réversible



\* Renewal Kits → 3753RK → P304

**3774P** Flexible Ratchet, reversible  
Gelenk-Knarre, verstellbar  
Cliquet articulé, réversible



\* Renewal Kits → 3753RK → P304

**3774N** Flexible Ratchet, reversible  
Gelenk-Knarre, verstellbar  
Cliquet articulé, réversible



	D (mm)	T (mm)	H (mm)	L (mm)	(g)	(pcs.)
3774J	30.5	26.4	15.7	285	367	1
3774P	30.5	26.4	15.7	265	378	2
3774N	30.5	26.4	15.7	265	378	2

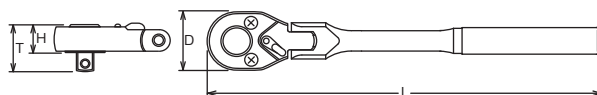

\* Renewal Kits → 3753BRK → P304

**3774JB**  
**3774PB**  
**3774NB** Flexible Ratchet, reversible with quick release button  
Gelenk-Knarre, verstellbar mit Entriegelungsknopf  
Cliquet, articulée, réversible avec bouton de débrayage



	D (mm)	T (mm)	H (mm)	L (mm)	(g)	(pcs.)
3774JB	30.5	26.4	15.7	285	367	1
3774PB	30.5	26.4	15.7	265	373	2
3774NB	30.5	26.4	15.7	265	378	2

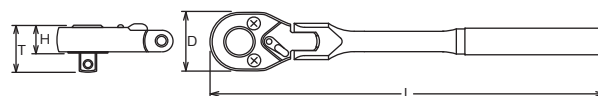

Reversible Ratchet with quick release button has less strength compared with normal ratchet due to the technical design. Make sure to use the ratchet correctly.

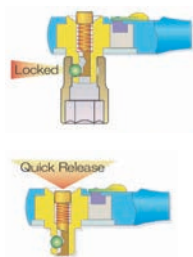

**Reversible Ratchet with Quick Release Button :**  
Sockets and accessories are safely locked. By pushing the button the sockets or extension bars are released from the ratchet.

**Umstellbare Knarre mit Entriegelungsknopf :**  
Steckschlüssel und Zubehörteile werden sicher und fest gehalten. Bei Drücken des Knopfes lösen sich die Teile.

**Cliquet réversible avec bouton de débrayage :**  
Les douilles et accessoires ne peuvent plus se libérer. Une pression du pouce sur le bouton suffit pour les extraire.

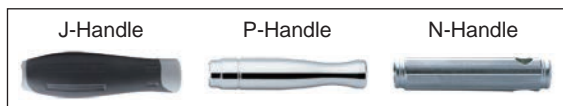

\* Renewal Kits → 3753RK → P304

**3774JL**  
**3774PL**  
**3774NL** Flex-Head Ratchet with Head Lock Button  
Gelenk-Knarre, mit feststellbarem Gelenk  
Cliquet à tête articulée avec bouton de blocage



	D (mm)	T (mm)	H (mm)	L (mm)	(g)	(pcs.)
3774JL	30.5	26.4	15.7	285	367	1
3774PL	30.5	26.4	15.7	265	378	2
3774NL	30.5	26.4	15.7	265	378	2

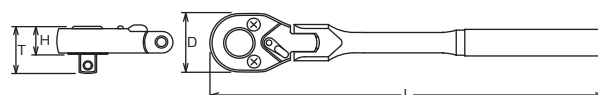

Z-SERIES  
HAND  
TITANIUM  
SCREWDRIVERS ACCESSORIES  
IMPACT  
SLEEVE-DRIVE  
PROTECTOR  
INDUSTRIAL  
AUTOMOTIVE  
CONSTRUCTION MOTORCYCLE  
SPARE PART

### 3774JBL

Flex-Head Ratchet with Head Lock Button and Quick Release Button  
Gelenk-Knarre, mit feststellbarem Gelenk und Entriegelungsknopf  
Cliquet à tête articulée avec bouton de blocage et de débrayage



\* Renewal Kits → 3753BRK → P304

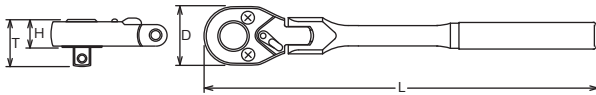

	D (mm)	T (mm)	H (mm)	L (mm)	(g)	(pce.)
3774JBL	30.5	26.4	15.7	285	367	1

⚠ Reversible Ratchet with quick release button has less strength compared with normal ratchet due to the technical design. Make sure to use the ratchet correctly.

### 3774P-SR

Speeder Ratchet  
Kurbel-Knarre  
Vilebrequin à cliquet



\* Renewal Kits → 3753RK → P304

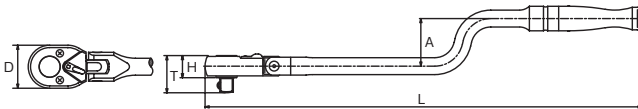

	D (mm)	T (mm)	H (mm)	A (mm)	L (mm)	(g)	(pce.)
3774P-SR	30.5	26.4	15.7	34	310	435	1

### 3776J

Swivel Head Ratchet  
Schwenkopf-Knarre  
Cliquet à tête pivotante



\* Renewal Kits → 3752RK → P305



### 3776P

Swivel Head Ratchet  
Schwenkopf-Knarre  
Cliquet à tête pivotante



\* Renewal Kits → 3752RK → P305



### 3776N

Swivel Head Ratchet  
Schwenkopf-Knarre  
Cliquet à tête pivotante



\* Renewal Kits → 3752RK → P305

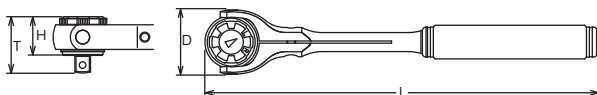

	D (mm)	T (mm)	H (mm)	L (mm)	(g)	(pce.)
3776J	44	34.3	23.9	280	510	1
3776P	44	34.3	23.9	280	560	1
3776N	44	34.3	23.9	280	565	1

45

\* Renewal Kits → 3755RK → P306

	D (mm)	L (mm)	(g)	(pcs.)
3755	30.5	55	146	5

	D (mm)	L (mm)	(g)	(pcs.)
3756	30.5	25.5	47	10

L/R Marking  
45

\* Renewal Kits → 3752RK → P306

	D (mm)	L (mm)	(g)	(pcs.)
3757	50	35	155	5

	D (mm)	L (mm)	(g)	(pcs.)
3762	19.3	300	178	2

**3755** Ratchet Adaptor  
Aufsteckknarre  
Cliquet adaptable

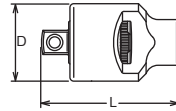

**3756** Quick Spinner  
Rändel-Drehscheibe  
Lanceur

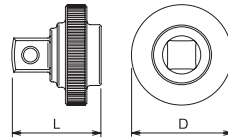

**3757** Ratchet Wheel  
Umstellbares Knarren-Handrad  
Cliquet réversible à roue

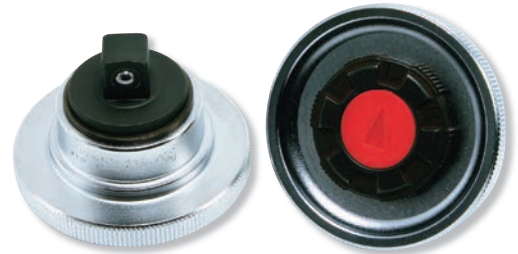
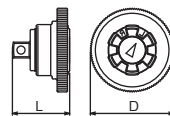

**3762** Flexible Extension Bar  
Biegsame Verlängerung  
Rallonge flexible

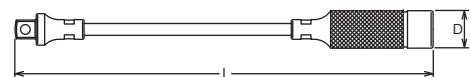

## 3760 Extension Bars Verlängerungen Rallonges

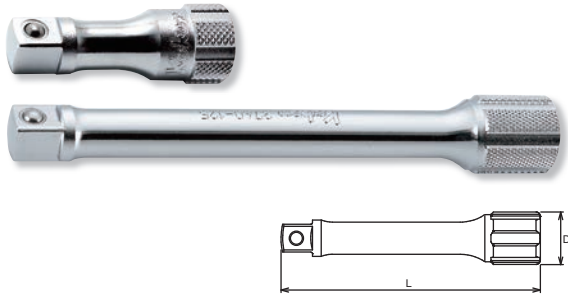

	D (mm)	L (mm)	(g)	(pcs.)
3760-32	18	32	27	10
3760-50	18	50	47	10
3760-75	18	75	68	10
3760-125	18	125	106	10
3760-150	18	150	125	10
3760-250	18	250	196	5
3760-300	18	300	291	2
3760-400	18	400	365	1
3760-500	18	500	490	1
3760-600	18	600	538	1
3760-900	18	900	805	1
3760-1000	18	1000	968	1

## PK3760/6 Extension Set in Plastic Box Verlängerungen in Kunststoffkassette Jeu de rallonges en boîte plastique



### PK3760/6 6 Pieces Set/△=670g

PLASTIC TRAY

Extension Bars

3760 Extension Bars  
32, 50, 75, 125, 150, 250

Rotation and general handling of extensions with oily hands is greatly improved with the **Koken** developed 6 point knurling. Also the **Koken** 6 point knurling stops the extensions from rolling around the work area.

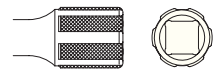

Durch die von **Koken** entwickelte 6 fache Rändelung wird die Handhabung deutlich erleichtert. Außerdem wird das Herumrollen der Verlängerungen wirksam verhindert.

La manipulation des rallonges est grandement facilitée par le profil moleté développé par **Koken**. Ce même profil empêche le roulement intempestif des rallonges sur le plan de travail.

## 3763 Wobble-Fix Extension Bars Winkel-Verlängerungen Rallonges angulaires

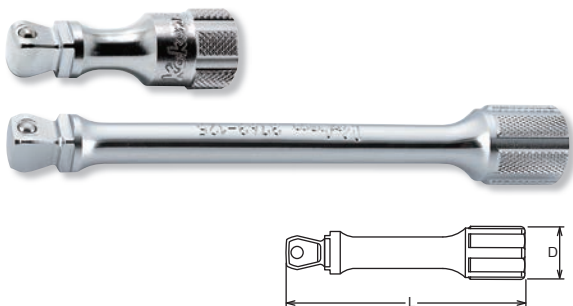

WOBBLE-FIX  
EXTENSION BAR



	D (mm)	L (mm)	(g)	(pcs.)
3763-32	18	32	26	10
3763-50	18	50	42	10
3763-75	18	75	57	10
3763-125	18	125	80	10
3763-150	18	150	98	10
3763-250	18	250	144	5
3763-300	18	300	170	2

## PK3763/6 Wobble-Fix Extension Bars in Plastic Box Winkel-Verlängerungen in Kunststoffkassette Jeu de rallonges angulaires en boîte plastique



### PK3763/6 6 Pieces Set/△=560g

PLASTIC TRAY

Extension Bars

3763 Wobble-Fix Extension Bars  
32, 50, 75, 125, 150, 250

#### Wobble-Fix Extension Bar

Two way usage

- In a fixed position, as a normal extension bar
- In a half-fixed position, as a flexible extension bar providing a 15° angle operation

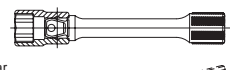

#### Winkel-Verlängerungen

Winkelverlängerungen lassen sich in zwei Einstellungen verwenden

- voll eingesteckt und starr,
- halb eingesteckt, mit einem Arbeitswinkel von 15°.

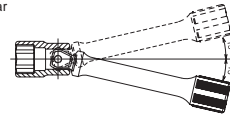

#### Rallonges angulaires

Deux utilisations possibles

- comme rallonge normale, dans une position fixe
- comme une rallonge angulaire avec une possibilité d'inclinaison jusqu'à 15°

The Wobble-Fix Extension Bar has less strength than normal extension bar due to it's specific design with a reduced square drive. Make sure to use it correctly.





\* Renewal Kits → 3768RK → P306



OVAL SHAPE SHANK



RENEWAL KIT FOR HINGE HANDLE

## 3768J-250

Hinge Handle  
Gelenkgriff  
Poignée articulée



\* Renewal Kits → 3768RK → P306

## 3768P-250

Hinge Handle  
Gelenkgriff  
Poignée articulée



\* Renewal Kits → 3768RK → P306

## 3768P-380

Hinge Handle  
Gelenkgriff  
Poignée articulée



	D (mm)	L (mm)	(g)	(pcs.)
3768J-250	20.5	250	248	2
3768P-250	20.5	250	275	5
3768P-380	20.5	380	435	2

**⚠** 3768P-380 has longer handle than standard, and can be loaded to excessive torque value. In the interest of your own safety always apply load evenly and progressively to avoid breakage and possible injury.

Der Gelenkgriff 3768-380 ist länger als die Standardversion. Aus Gründen Ihrer Sicherheit, sollten dies Werkzeug nie ruckartig sondern nach und nach belastet werden, um Bruch und damit verbundene, mögliche Verletzungen zu vermeiden.

Dû au fait que les manches des 3768-380 sont plus longues que le standard, il y a risque d'une surcharge excessive lors du serrage. Pour éviter casse et blessure, veuillez serrer d'une façon régulière et progressive.

3769N	H (mm)	L (mm)	(g)	(pcs.)
160	50	160	96	2
230	120	230	126	2



WOBBLE-FIX EXTENSION BAR



3769NWF	H (mm)	L (mm)	(g)	(pcs.)
160	50	160	96	2
230	120	230	126	2

**⚠** Plastic or rubber handles are not intended to act as insulation.

Plastik-oder Gummigriffe stellen keinen Isolierschutz dar.

Les poignées en plastique ou en caoutchouc ne garantissent aucune isolation électrique.

3769H	L (mm)	(g)	(pcs.)
3769H	170	210	2

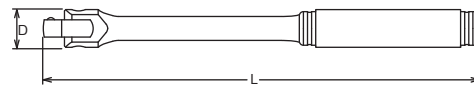

## 3769N-160 / -230

Spin Type Handle  
Drehgriff  
Poignée emmanchée

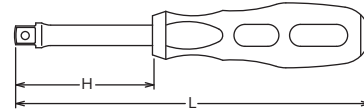

## 3769NWF-160 / -230

Spin Type Handle Wobble-Fix  
Drehgriff, Wobble-Fix  
Poignée emmanchée, angulaire

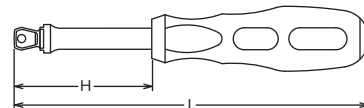

## 3769H

Folding Socket Driver  
Klapp-Drehgriff  
Poignée tournevis articulée

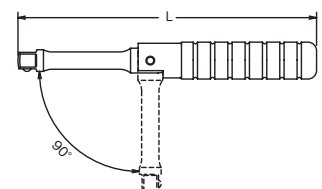

Z-SERIES  
HAND  
TITANIUM  
SCREWDRIVERS ACCESSORIES  
IMPACT  
SLEEVE-DRIVE  
PROTECTOR  
INDUSTRIAL  
AUTOMOTIVE  
MOTORCYCLE  
CONSTRUCTION  
SPARE PART

**3770** Universal Joint  
Gelenk-Einsatz  
Cardan universel

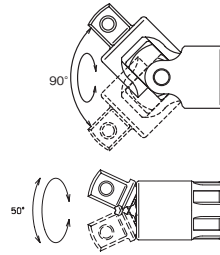

**3771** Universal Joint  
Gelenk-Einsatz  
Joint articulé



	L (mm)	(g)	(pcs.)
<b>3770</b>	50	66	10
<b>3771</b>	43	46	10

**3780** Speed Handle  
Winde  
Vilebrequin

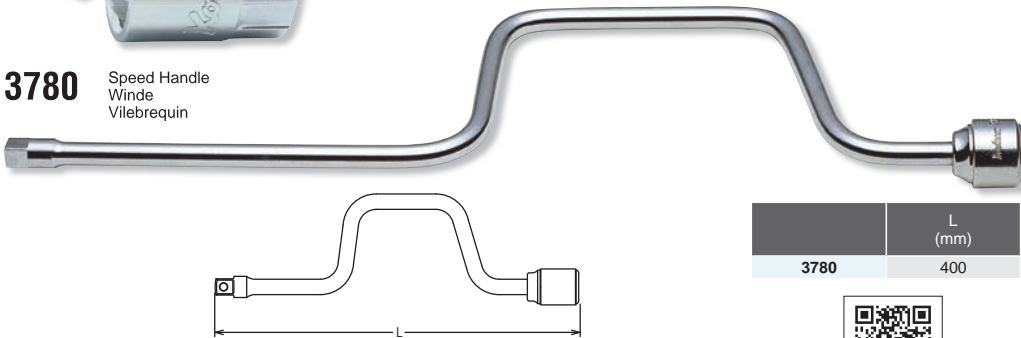

	L (mm)	(g)	(pcs.)
<b>3780</b>	400	432	1

**3785** T-Handle  
T-Griff  
Poignée coulissante

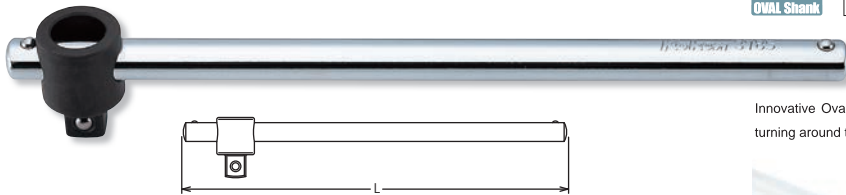

Innovative Oval shaped bar provides higher durability and stops the sliding square part turning around the bar.



**3322A** Adaptor  
Verbindungsstück  
Augmentateur

Warranty 86Nm  
Garantie 86Nm  
Garantie 86Nm

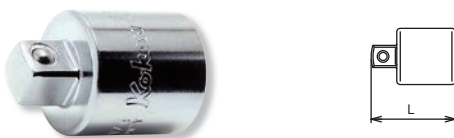

**3344A** Adaptor  
Verbindungsstück  
Augmentateur



	L (mm)	(g)	(pcs.)
<b>3785</b>	200	157	5

	(sq)	(sq)	L (mm)	(g)	(pcs.)
<b>3322A</b>	3/8"	1/4"	24	18	10
<b>3344A</b>	3/8"	1/2"	30	35	10

⚠ Adapting down from bigger square drive to smaller square drive may lead to excessive torque and possibly cause breakage.

Reduzierstücke sind mit Vernunft einzusetzen. Es besteht Bruchgefahr. Überschreiten Sie niemals die Sicherheitsgrenzen.

Les réducteurs doivent être utilisés avec modération. Ne dépassez jamais la limites de sécurité.

**PK2346/6** Adaptor Set in Plastic Box  
Adaptor Satz in Kunststoffkassette  
Jeu de adaptateur en boîte plastique



- 2233A (11/4") X 3/8"
- 3322A (3/8") X 1/4" Warranty/Garantia 86Nm
- 3344A (3/8") X 1/2"
- 4433A (11/2") X 3/8" Warranty/Garantia 290Nm
- 4466A (11/2") X 3/4"
- 6644A (3/4") X 1/2" Warranty/Garantia 668Nm

PK2346/6		6 Pieces Set/6=460g	
PLASTIC TRAY			
Adaptors			
1/4" □ → 3/8" □	2233A	3/8" □ → 1/4" □	3322A
3/8" □ → 1/2" □	3344A	1/2" □ → 3/8" □	4433A-35
1/2" □ → 3/4" □	4466A	3/4" □ → 1/2" □	6644A

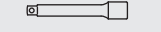
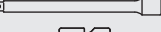
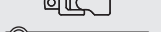
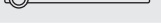
<b>ESH3001</b> 17 Pieces Set/△=2,200g	
METAL CASE:W415xH120xT50mm	
Sockets	Accessories
<b>3410M</b> Surface Drive Sockets 8, 9, 10, 11, 12, 13, 14, 15, 16, 17, 18, 19	 <b>3753J</b>  <b>3760-125</b>  <b>3760-250</b>  <b>3770</b>  <b>3785</b>









**ESH3001** Socket Set  
Steckschlüssel Satz  
Jeu de clés à douille

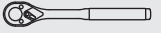

<b>ETH3001</b> 22 Pieces Set/△=1,820g	
METAL CASE:W392xH90xT50mm	
Sockets	Accessory
<b>3425 TORX®</b> Sockets E4, E5, E6, E7, E8  <b>4425 TORX®</b> Sockets E10, E11, E12, E14, E16, E18  <b>3025.50 TORX®</b> Bit Sockets T10, T15, T20, T25, T27  <b>4025.60 TORX®</b> Bit Sockets T30, T40, T45, T50, T55	 <b>4433A-35</b>



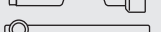
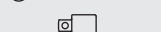

**ETH3001** Socket Set  
Steckschlüssel Satz  
Jeu de clés à douille



<b>3201AMW</b> 42 Pieces Set/△=4,700g	
METAL CASE:W445xH190xT50mm	
Sockets	Accessories
<b>3405M</b> 12-pt. Sockets 9, 10, 11, 12, 13, 14, 15, 16, 17, 18, 19, 20, 21, 22  <b>3405A</b> 12-pt. Sockets 5/16, 3/8, 7/16, 1/2, 9/16, 5/8, 11/16, 3/4, 25/32, 13/16, 7/8  <b>3405W</b> 12-pt. Sockets 1/8, 3/16, 1/4, 5/16, 3/8, 7/16, 1/2	 <b>3753N</b>  <b>3760-75</b>  <b>3760-125</b>  <b>3760-250</b>  <b>3768N-250</b>  <b>3769N-160</b>  <b>3770</b>  <b>3780</b>  <b>3785</b>  <b>3344A</b>

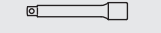



**3201AMW** Socket Set  
Steckschlüssel Satz  
Jeu de clés à douille



<b>3206AM</b> 27 Pieces Set/△=3,500g	
METAL CASE:W445xH190xT50mm	
Sockets	Accessories
<b>3405M</b> 12-pt. Sockets 7, 8, 10, 11, 12, 13, 14, 15, 16, 17, 19, 22  <b>3405A</b> 12-pt. Sockets 3/8, 7/16, 1/2, 9/16, 5/8, 11/16, 3/4, 13/16, 7/8  <b>3300C</b> Spark Plug Socket 20.8	 <b>3753J</b>  <b>3760-125</b>  <b>3760-250</b>  <b>3768J-250</b>  <b>3770</b>

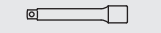
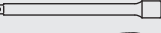



**3206AM** Socket Set  
Steckschlüssel Satz  
Jeu de clés à douille

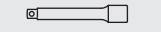
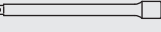

<b>3210M-00</b> 22 Pieces Set/△=2,900g <b>3210M-05</b> 22 Pieces Set/△=2,900g <b>3210M-10</b> 22 Pieces Set/△=2,900g	
METAL CASE:W360xH145xT50mm	
Sockets	Accessories
(3210M-00) <b>3400M</b> 6-pt. Sockets 6, 7, 8, 9, 10, 11, 12, 13, 14, 15, 16, 17, 18, 19, 21, 22  (3210M-05) <b>3405M</b> 12-pt. Sockets 6, 7, 8, 9, 10, 11, 12, 13, 14, 15, 16, 17, 18, 19, 21, 22  (3210M-10) <b>3410M</b> Surface Drive Sockets 6, 7, 8, 9, 10, 11, 12, 13, 14, 15, 16, 17, 18, 19, 21, 22	 <b>3753J</b>  <b>3760-125</b>  <b>3760-250</b>  <b>3768J-250</b>  <b>3770</b>  <b>3785</b>

**3210M-00 / 3210A-00** Socket Set  
Steckschlüssel Satz  
Jeu de clés à douille  
**3210M-05**  
**3210M-10**

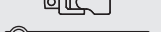

<b>3210A-00</b> 18 Pieces Set/△=2,760g	
METAL CASE:W360xH145xT50mm	
Sockets	Accessories
<b>3400A</b> 6-pt. Sockets 1/4, 5/16, 11/32, 3/8, 7/16, 1/2, 9/16, 5/8, 11/16, 3/4, 13/16, 7/8	 <b>3753J</b>  <b>3760-125</b>  <b>3760-250</b>  <b>3768J-250</b>  <b>3770</b>  <b>3785</b>

Z-SERIES  
HAND  
TITANIUM  
ACCESSORIES  
SCREWDRIVERS  
IMPACT  
SLEEVE-DRIVE  
PROTECTOR  
INDUSTRIAL  
AUTOMOTIVE  
MOTORCYCLE  
CONSTRUCTION  
SPARE PART

**3216** Spark Plug Sockets Set  
Zündkerzen-Schlüssel Satz  
Jeu de douilles pour bougies



<b>3216</b> 4 Pieces Set/△=730g	
PLASTIC BAG	
Sockets	Accessories
<b>3300C</b> Spark Plug Sockets 16, 20.8	<b>3760-125</b> <b>3774JL</b>

**3217M-00** Socket Set  
Steckschlüssel Satz  
Jeu de clés à douille  
**3217M-05**  
**3217M-10**



<b>3217M-00</b>	14 Pieces Set/△=850g
<b>3217M-05</b>	14 Pieces Set/△=850g
<b>3217M-10</b>	14 Pieces Set/△=850g
METAL CASE:W163xH52xT33mm	
Sockets	
(3217M-00) <b>3400M</b> 6-pt. Sockets 9, 10, 11, 12, 13, 14, 15, 16, 17, 18, 19, 20, 21, 22	
(3217M-05) <b>3405M</b> 12-pt. Sockets 9, 10, 11, 12, 13, 14, 15, 16, 17, 18, 19, 20, 21, 22	
(3217M-10) <b>3410M</b> Surface Drive Sockets 9, 10, 11, 12, 13, 14, 15, 16, 17, 18, 19, 20, 21, 22	

**S3240M-00 / S3240A-00** Display Stands  
Ausstellungsständer  
**S3240M-05 / S3240A-05** Présentoirs



<b>S3240M-00</b>	3400M 177 Pieces Set/△=10,300g	
<b>S3240M-05</b>	3405M 177 Pieces Set/△=10,300g	
DISPLAY STAND:W510xH150xT230mm		
Sockets		
6mm:12pcs	12mm:12pcs	18mm:8pcs
7mm:12pcs	13mm:11pcs	19mm:8pcs
8mm:12pcs	14mm:11pcs	20mm:7pcs
9mm:12pcs	15mm:10pcs	21mm:7pcs
10mm:12pcs	16mm: 9pcs	22mm:7pcs
11mm:12pcs	17mm: 9pcs	23mm:6pcs

<b>S3240A-00</b>	3400A 126 Pieces Set/△=8,500g	
<b>S3240A-05</b>	3405A 126 Pieces Set/△=8,500g	
DISPLAY STAND:W510xH150xT230mm		
Sockets		
1/4" :12pcs	9/16":10pcs	25/32":7pcs
5/16":12pcs	19/32":10pcs	13/16":7pcs
3/8" :12pcs	5/8" : 9pcs	7/8" :7pcs
7/16":12pcs	11/16": 9pcs	
1/2" :11pcs	3/4" : 8pcs	





**3250M-00** Socket Set  
Steckschlüssel Satz  
Jeu de clés à douille  
**3250M-05**



<b>3250M-00</b>	17 Pieces Set/△=2,200g	
<b>3250M-05</b>	17 Pieces Set/△=2,200g	
METAL CASE:W415xH120xT50mm		
Sockets	Accessories	
<b>3400M</b> 6-pt. Sockets 7, 8, 10, 11, 12, 13, 14, 15, 16, 17, 18, 19	<b>3753J</b> <b>3760-125</b>	
<b>3405M</b> 12-pt. Sockets 7, 8, 10, 11, 12, 13, 14, 15, 16, 17, 18, 19	<b>3760-250</b> <b>3770</b> <b>3785</b>	

**3251** 8 Pieces Set/△=675g

METAL CASE:W160xH100xT28mm

Sockets	Accessories
 <b>3025.50 TORX® Bit Sockets</b> T25H, T30H, T40H, T45H, T50H	 <b>2774PS-3/8</b>
	 <b>3763-50</b>
	 <b>3756</b>





**3251**

Bit Socket Set  
Schraubendreher-Steckschlüssel Satz  
Jeu de douilles de vissage

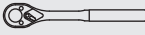

**3252M** 15 Pieces Set/△=1,530g

METAL CASE:W310xH90xT48mm

Sockets	Accessories
 <b>3400M 6-pt. Sockets</b> 5.5, 7, 8, 10, 11, 12	 <b>3753P</b>
 <b>3405M 12-pt. Sockets</b> 13, 14, 17, 19, 22	 <b>3760-75</b>
	 <b>3760-125</b>
	 <b>3770</b>







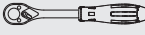

**3252M**

Socket Set  
Steckschlüssel Satz  
Jeu de clés à douille



**3275** 24 Pieces Set/△=3,150g

METAL CASE:W400xH147xT50mm

Sockets	Accessories
 <b>3400M 6-pt. Sockets</b> 6, 7, 8, 9, 10, 11, 12	 <b>3753J</b>
 <b>3405M 12-pt. Sockets</b> 13, 14, 15, 16, 17, 18, 19, 21, 22	 <b>3760-125</b>
 <b>3300C Spark Plug Sockets</b> 16, 20.8	 <b>3760-250</b>
	 <b>3768J-250</b>
	 <b>3770</b>
	 <b>3756</b>







**3275**

Socket Set  
Steckschlüssel Satz  
Jeu de clés à douille

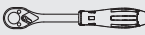

**3277** 29 Pieces Set/△=3,240g

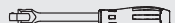
METAL CASE:W370xH150xT50mm

Sockets	Accessories
 <b>3400M 6-pt. Sockets</b> 8, 9, 10, 11, 12	 <b>3753J</b>
 <b>3405M 12-pt. Sockets</b> 13, 14, 15, 16, 17, 18, 19, 21	 <b>3760-125</b>
 <b>3300M 6-pt. Deep Sockets</b> 8, 9, 10, 11, 12	 <b>3768J-250</b>
 <b>3305M 12-pt. Deep Sockets</b> 13, 14, 15, 16, 17, 18, 19, 21	





**3277**

Socket Set  
Steckschlüssel Satz  
Jeu de clés à douille

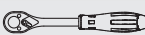

**3278** 20 Pieces Set/△=3,370g

METAL CASE:W310xH150xT50mm

Sockets	Accessories
 <b>3000 Bit Sockets</b> 2, 3	 <b>3753J</b>
 <b>3010M.62 Hex Bit Sockets</b> 5, 6, 7, 8, 10	 <b>3763-125</b>
 <b>3020.50 XZN Bit Sockets</b> M4, M5, M6, M8	
 <b>3025.50 TORX® Bit Sockets</b> T10, T15, T20, T25, T27, T30, T40	

**3278**

Bit Socket Set  
Schraubendreher-Steckschlüssel Satz  
Jeu de douilles de vissage



# Hand Sockets Hand Steckschlüssel Douilles à main

# 1/2"

Z-SERIES  
HAND  
TITANIUM  
SCREWDRIVERS ACCESSORIES  
IMPACT  
SLEEVE-DRIVE  
PROTECTOR  
INDUSTRIAL  
AUTOMOTIVE  
CONSTRUCTION MOTORCYCLE  
SPARE PART

## 4401M 6-point Sockets 6-kant Steckschlüssel Douilles 6-pans



HANDY-ENDY®

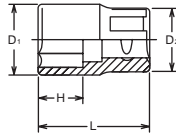

## 4406M 12-point Sockets 12-kant Steckschlüssel Douilles 12-pans



HANDY-ENDY®

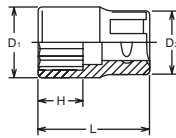

## 4400M 6-point Sockets 6-kant Steckschlüssel Douilles 6-pans

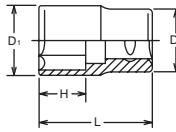

## 4405M 12-point Sockets 12-kant Steckschlüssel Douilles 12-pans

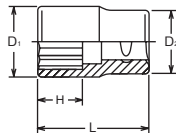

## RS4401M/10 Socket Set on Rail Steckschlüsselsatz auf Schiene Jeu de douilles sur rail



4401M 4406M (mm)	D <sub>1</sub> (mm)	D <sub>2</sub> (mm)	H (mm)	L (mm)	(g)	(pcs.)
8	13.2	22	8	36	44	10
9	13.8	22	8.5	37	44	10
10	15.3	22	9	37	45	10
11	16.5	22	9.5	37	46	10
12	17.8	22	10	37	47	10
13	19	22	10.5	37	53	10
14	20.3	22	11	37	56	10
15	21.5	22	11.5	37	52	10
16	22.8	22	12	37	62	10
17	24	22	12.5	37	69	10
18	25	23	13	37	74	10
19	26.5	24.5	14	38	89	10
20	27.8	26	15	38	92	10
21	29	27	15.5	38	102	10
22	30	28	16	40	113	10
23	31.5	29	16.5	40	128	10
24	32.8	30	17	42	140	5
25	34	31	18	42	164	5
26	35	32	19	42	165	5
27	36.5	33	19.5	43	196	5
28	37.8	34	20	43	198	5
29	39	35	20.5	43	190	5
30	40	36	22	46	222	5
31	41.5	37	22.5	46	257	5
32	42.8	38	23	46	250	5

4400M 4405M (mm)	D <sub>1</sub> (mm)	D <sub>2</sub> (mm)	H (mm)	L (mm)	(g)	(pcs.)
33	44.2	39	24	47	275	5
34	45.2	40	24	47	315	5
35	46.2	40	24	47	317	5
36	47.2	41	24	47	336	5
37	48.3	42	24	47	360	5
38	49.2	43	24	47	380	5
41	53.1	45	29	57	471	5
46	59.1	48	32	60	567	2

## RS4406M/10 Socket Set on Rail Steckschlüsselsatz auf Schiene Jeu de douilles sur rail



RS4401M/10	10 Pieces Set/Rail 300mm	(g)
10, 11, 12, 13, 14, 15, 16, 17, 18, 19		720

RS4406M/10	10 Pieces Set/Rail 300mm	(g)
10, 11, 12, 13, 14, 15, 16, 17, 18, 19		720

4400A 4405A (inch)	D <sub>1</sub> (mm)	D <sub>2</sub> (mm)	H (mm)	L (mm)	(g)	(pcs.)
1/4	10.7	21	6	36	41	10
5/16	13.2	21	8	36	44	10
3/8	14.6	21	9	37	45	10
7/16	16.5	21	9.5	37	46	10
1/2	19	22	10.5	37	53	10
9/16	20.3	22	11	37	56	10
19/32	21.5	22	11.5	37	52	10
5/8	22.8	22	12	37	62	10
21/32	24	23	12.5	37	69	10
11/16	25	24	13	37	74	10
3/4	26.5	25	14	38	89	10
25/32	27.8	26	15	38	92	10
13/16	29	27	15.5	38	102	10
7/8	30	28	16	40	113	10
15/16	32.8	30	17	42	140	5
31/32	34	31	18	42	165	5
1	35	32	19	42	165	5
1. 1/16	36.5	33	19.5	43	180	5
1. 1/8	39	35	20.5	43	210	5
1. 3/16	40	36	22	46	222	5
1. 1/4	42.8	38	23	46	250	5
1. 5/16	44.2	39	24	47	275	5
1. 3/8	46.2	40	24	47	317	5
1. 7/16	47.2	41	24	47	336	5
1. 1/2	49.2	43	24	47	380	5

Hand Sockets  
Both, 6-pt. and 12-pt. openings, are equipped with Flat Drive Openings, transferring the turning power from the corners on the flanks of nuts and bolts.

Sowohl 6-kant als auch 12-kant Steckschlüssel bieten alle Vorteile der "Flat Drive" Öffnung, die die Greifzonen auf die Flächen von Schrauben und Muttern versetzt.

Aussi bien les douilles 6-pans que 12-pans présentent tous les avantages liés au profil FLATDRIVE qui applique la force de serrage aux faces de la vis ou de l'écrou.

## 4400A 6-point Sockets 6-kant Steckschlüssel Douilles 6-pans

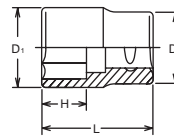

## 4405A 12-point Sockets 12-kant Steckschlüssel Douilles 12-pans

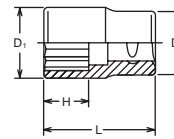

RS4400A/10	10 Pieces Set/Rail 300mm	(g)
3/8, 7/16, 1/2, 9/16, 5/8, 11/16, 3/4, 13/16, 7/8, 15/16		809
RS4405A/10	10 Pieces Set/Rail 300mm	(g)
3/8, 7/16, 1/2, 9/16, 5/8, 11/16, 3/4, 13/16, 7/8, 15/16		809

## RS4400A/10 Socket Set on Rail Steckschlüsselsatz auf Schiene Jeu de douilles sur rail



	6-Point	12-Point	Surface Drive	Nut Grip®	TORX® (E)	TORXPLUS® (EPL)	Double Square	LHSTIX® (LH-S)
1/4"	No. 2400M/A No. 2300M/A No. 2400W-BA No. 2300W-BA No. 2300X series	No. 2405M/A No. 2305M/A No. AS2405A No. AS2305A series	No. 2410M No. 2310M series	No. 2450MS No. 2350M No. 2350X series	No. 2425 No. 2325 series	—	No. 2415M/A series	—
3/8"	No. 3400M/A No. 3300M/A No. 3400W No. 3300W No. 3300X/XA series	No. 3405M/A No. 3305M/A No. 3405W No. 3305W No. 3305X/XA series	No. 3410M No. 3310M series	No. 3450M No. 3450MH No. 3350M No. 3350X series	No. 3425 No. 3325 series	—	No. 3415M/A series	No. 3400LH series
1/2"	No. 4400M/A No. 4401M No. 4300M/A No. 4400W series	No. 4405M/A No. 4406M No. 4305M/A No. 4405W series	No. 4410M No. 4310M series	No. 4450M series	No. 4425 No. 4325 series	No. 4425-EPL series	—	No. 4400LH series

## 4410M

Surface Drive Sockets  
Surface Drive Steckschlüssel  
Douilles, Surface Drive

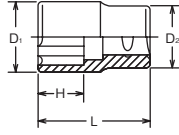

## RS4410M/10

Socket Set on Rail  
Steckschlüsselsatz auf Schiene  
Jeu de douilles sur rail



## SURFACE DRIVE

Surface drive sockets are designed to retain contact with the flat sides of the nut in order to transmit higher torque and reduce nut wear. These sockets are ideal for using on polished nuts, aluminum nuts and nuts with worn out points.

Das Profil unserer Surface-Drive Steckschlüssel greift die Schraube an deren Flächen. Dies sichert eine höhere Kraftübertragung und verhindert ein Durchrutschen des Steckschlüssels. Diese Steckschlüssel eignen sich besonders für polierte Schrauben, Aluminium Schrauben und Schrauben bei denen die Ecken bereits abgerundet sind.

Notre profil Surface Drive assure le contact entre la douille et les plats de l'écrou. Ceci réduit l'usure et permet la transmission d'un couple plus élevé. C'est une solution idéale pour les écrous polies, celles en aluminium ou arrondies.

4410M (mm)	D <sub>1</sub> (mm)	D <sub>2</sub> (mm)	H (mm)	L (mm)	(g)	(pcs.)
8	13.2	21	8	36	44	10
9	13.8	21	8.5	37	44	10
10	15.3	21	9	37	45	10
11	16.5	21	9.5	37	46	10
12	17.8	21	10	37	47	10
13	19	22	10.5	37	53	10
14	20.3	22	11	37	56	10
15	21.5	22	11.5	37	52	10
16	22.8	22	12	37	62	10
17	24	23	12.5	37	69	10
18	25	24	13	37	74	10
19	26.5	25	14	38	89	10
20	27.8	26	15	38	92	10
21	29	27	15.5	38	102	10
22	30	28	16	40	113	10
23	31.5	29	16.5	40	128	10
24	32.8	30	17	42	140	5
25	34	31	18	42	164	5
26	35	32	19	42	165	5
27	36.5	33	19.5	43	196	5
28	37.8	34	20	43	198	5
29	39	35	20.5	43	190	5
30	40	36	22	46	222	5
31	41.5	37	22.5	46	257	5
32	42.8	38	23	46	250	5
34	45.2	40	24	47	314	5

RS4410M/10	10 Pieces Set/Rail 300mm	(g)
10, 11, 12, 13, 14, 15, 17, 19, 21, 22		717

4400W 4405W (W)	D <sub>1</sub> (mm)	D <sub>2</sub> (mm)	H (mm)	L (mm)	(g)	(pcs.)
3/16	16.5	21	9.5	37	46	10
1/4	19	22	10.5	37	54	10
5/16	21.5	22	11.5	37	54	10
3/8	25	24	13	37	73	10
7/16	29	27	15.5	38	87	10
1/2	31.5	29	16.5	40	133	10
9/16	35	32	19	42	165	5
5/8	37.8	34	20	43	191	5
11/16	40	36	22	46	222	5
3/4	44.2	39	24	47	280	5

RS4400W/8	8 Pieces Set/Rail 250mm	(g)
3/16, 1/4, 5/16, 3/8, 7/16, 1/2, 9/16, 5/8		860

RS4405W/8	8 Pieces Set/Rail 250mm	(g)
3/16, 1/4, 5/16, 3/8, 7/16, 1/2, 9/16, 5/8		860

## 4400W

6-point Whitworth Sockets  
6-kant Steckschlüssel, Whitworth  
Douilles à 6-pans Whitworth

## 4405W

12-point Whitworth Sockets  
12-kant Steckschlüssel, Whitworth  
Douilles à 12-pans Whitworth

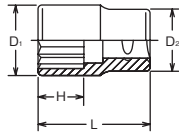

## RS4400W/8

Socket Set on Rail  
Steckschlüsselsatz auf Schiene  
Jeu de douilles sur rail



### BS W



BS-W	BS	3/16BS	1/4BS	5/16BS	3/8BS	7/16BS	1/2BS	9/16BS	5/8BS	11/16BS	3/4BS	7/8BS
	W	1/8W	3/16W	1/4W	5/16W	3/8W	7/16W	1/2W	9/16W	5/8W	11/16W	3/4W
Across Flat	(ref. mm)	8.64	11.30	13.34	15.24	18.03	20.83	23.37	25.65	27.94	30.48	33.35

## 4425-N

TORX® Sockets  
TORX® Steckschlüssel  
Douilles TORX®

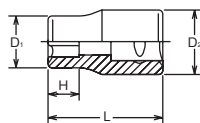

## RS4425/6-N

Socket Set on Rail  
Steckschlüsselsatz auf Schiene  
Jeu de douilles sur rail



4425 (E)	D <sub>1</sub> (mm)	D <sub>2</sub> (mm)	H (mm)	L (mm)	(g)	(pcs.)
E10N	13.2	21	8.2	36	47	10
E12N	14.6	21	9.3	37	48	10
E14N	16.5	21	10.6	37	50	10
E16N	19	22	11.8	37	60	10
E18N	20.3	22	13	37	60	10
E20N	22.8	22	14.4	37	65	10

TORX Socket for Nut and low profile bolt  
Shallow Chamfer on Socket Opening



A : Flywheel bolt MR20 NISSAN: 4425-E20N  
B : Cam sprocket FA20 for TOYOTA/SUBARU: 4425-E16N  
C : Connecting rod bolt FA20 for TOYOTA/SUBARU: 4425-E14N

RS4425/6-N	6 Pieces Set/Rail 200mm	(g)
E10N, E12N, E14N, E16N, E18N, E20N		370



4425 (E)	D <sub>1</sub> (mm)	D <sub>2</sub> (mm)	H (mm)	L (mm)	(g)	(pcs.)
E 8	10.7	21	7	36	41	10
E10	13.2	21	8.2	36	44	10
E11	13.8	21	8.7	37	45	10
E12	14.6	21	9.3	37	47	10
E14	16.5	21	10.6	37	48	10
E16	19	22	11.8	37	57	10
E18	20.3	22	13	37	57	10
E20	22.8	22	14.4	37	63	10
E22	25	24	15.5	37	78	10
E24	26.5	25	17	40	95	5

RS4425/7	7 Pieces Set/Rail 200mm	(g)
E10, E12, E14, E16, E18, E20, E24		428

### 4425 TORX® Sockets TORX® Steckschlüssel Douilles TORX®

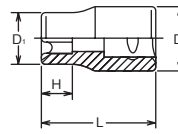

### RS4425/7 Socket Set on Rail Steckschlüsselsatz auf Schiene Jeu de douilles sur rail



### TORX® (E)

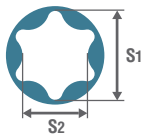

E	E4	E5	E6	E7	E8	E10	E11	E12	E14	E16	E18	E20	E22	E24	E26	E28	E30	E32
S <sub>1</sub> (ref. mm)	3.7	4.6	5.6	6.1	7.4	9.3	9.9	11.0	12.8	14.6	16.5	18.3	20.1	22.0	23.7	25.5	27.3	29.0
S <sub>2</sub> (ref. mm)	2.7	3.3	4.0	4.3	5.3	6.8	7.1	7.9	9.2	10.5	11.9	13.2	14.8	15.7	17.5	18.3	20.0	21.3

4425 (EPL)	D <sub>1</sub> (mm)	D <sub>2</sub> (mm)	H (mm)	L (mm)	(g)	(pcs.)
10EPL	13.2	21	6.2	36	45	10
12EPL	14.6	21	7.2	37	47	10
14EPL	16.5	21	8.1	37	49	10
16EPL	19	22	9.2	37	60	10
18EPL	20.3	22	10.2	37	60	10
20EPL	22.9	22	11.2	37	65	10

RS4425/6-EPL	6 Pieces Set/Rail 200mm	(g)
10EPL, 12EPL, 14EPL, 16EPL, 18EPL, 20EPL		390

### 4425 (EPL) TORXPLUS® Sockets TORXPLUS® Steckschlüssel Douilles TORXPLUS®

**TORXplus®**

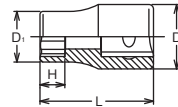

### RS4425/6-EPL Socket Set on Rail Steckschlüsselsatz auf Schiene Jeu de douilles sur rail



### TORXplus® (EP/EPL)

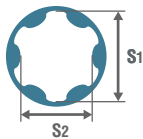

EP/EPL	8EP	10EP	12EP	14EP	16EP	18EP	20EP	22EP	24EP	26EP	28EP	30EP	32EP
S <sub>1</sub> (ref. mm)	7.4	9.3	11.0	12.8	14.6	16.5	18.3	20.1	22.0	23.7	25.5	27.3	29.0
S <sub>2</sub> (ref. mm)	5.3	6.8	7.9	9.2	10.5	11.9	13.2	14.8	15.7	17.5	18.3	20.0	21.3

# TORXplus®

TORX PLUS  
EP/EPL-style



TORX  
E-style



#### Straight Sidewalls & Reduced Recess Fall Away

- Increase tool engagement
- Virtually eliminates camout
- Ensures proper torque transfer
- Greatly reduces end load requirements
- Can reduce worker fatigue and muscular stress during manual assembly

#### Elliptically-based Geometry and Lobe Engagement

- Broadens contact surface to maximize engagement of driver and recess
- Eliminates damaging point-to-point contact

#### 0° Drive Angle

- Optimises torque transmission
- Virtually eliminates radial stresses to increase tool bit life
- Enables use of recesses with thinner walls

#### Six Lobes with Large Cross-Sectional Areas

- Enables faster tool engagement
- Maximizes torque transfer
- Increases torsional strength

TORX is a registered trademark of Acument Intellectual Properties, LLC.  
TORX ist ein registriertes Markenzeichen der Firma Acument Intellectual Properties, LLC.  
TORX est une marque déposée de Acument Intellectual Properties, LLC.

TORXplus is a registered trademark of Acument Intellectual Properties, LLC.  
TORXplus ist ein registriertes Markenzeichen der Firma Acument Intellectual Properties, LLC.  
TORXplus est une marque déposée de Acument Intellectual Properties, LLC.

# Hand Sockets Hand Steckschlüssel Douilles à main

# 1/2"

Z-SERIES  
HAND  
TITANIUM  
SCREWDRIVERS  
ACCESSORIES  
IMPACT  
SLEEVE-DRIVE  
PROTECTOR  
INDUSTRIAL  
AUTOMOTIVE  
MOTORCYCLE  
CONSTRUCTION  
SPARE PART

## 4400LH

 LHSTIX® Sockets  
Steckschlüssel mit LHSTIX® Profil  
Douilles au profil LHSTIX®

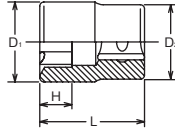

4400LH (LH-S)	D <sub>1</sub> (mm)	D <sub>2</sub> (mm)	H (mm)	L (mm)	(g)	(pcs.)
6S	13.2	21	5.6	36	44	10
8S	16.5	21	6.8	37	46	10
10S	19	22	8	37	53	10
12S	22.8	22	9.2	37	62	10
14S	25	24	10.4	37	74	10
16S	29	27	11.6	38	102	10

## RS4400LH/6

  Socket Set on Rail  
Steckschlüsselsatz auf Schiene  
Jeu de douilles sur rail



RS4400LH/6	6 Pieces Set/Rail 200mm	(g)
6S, 8S, 10S, 12S, 14S, 16S		430

### LHSTIX®

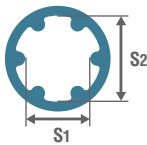

	LH-S	LH-5S	LH-6S	LH-8S	LH-10S	LH-12S	LH-14S	LH-16S
S <sub>1</sub>	(ref. mm)	5.6	6.8	9.0	11.3	13.6	15.8	18.1
S <sub>2</sub>	(ref. mm)	7.5	9.0	12.0	15.0	18.0	21.0	24.0

## 4450M

 Nut Grip Sockets **Nut Grip®**  
Steckschlüssel mit 2-facher Kugelhalterung  
Douilles à billes de retenue

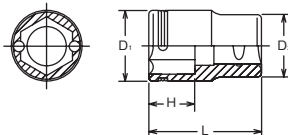

4450M (mm)	D <sub>1</sub> (mm)	D <sub>2</sub> (mm)	H (mm)	L (mm)	(g)	(pcs.)
10	15.3	21	6	36	44	10
11	16.5	21	6.5	36	46	10
12	17.8	21	7	36	46	10
13	19	22	8	36	52	10
14	20.3	22	8.5	36	54	10
15	21.5	22	9	36	52	10
16	22.8	22	9	36	60	10
17	24	23	9.5	36	68	10
18	25	24	10.5	36	77	10
19	26.5	25	11.5	36	85	10
21	29	27	12	37	110	10
22	30	28	12.5	37	105	10
24	32.8	30	14.5	39	130	5
27	36.5	33	16.5	40	139	5

## NUT GRIP®

Twin balls at the 6-point opening hold bolt/nut tightly for safe and reliable work.

Die zwei Kugeln in der 6-kant Öffnung unserer NUT GRIP Steckschlüssel halten die Schraube sicher im Steckschlüssel. Dies erlaubt ein Arbeiten auch an schwer zugänglichen Stellen.

Les 2 billes dans l'ouverture du 6-pans de la douille retiennent l'écrou de manière sûre et efficace.

## RS4450M/10

  Socket Set on Rail  
Steckschlüsselsatz auf Schiene  
Jeu de douilles sur rail



RS4450M/10	10 Pieces Set/Rail 300mm	(g)
10, 11, 12, 13, 14, 15, 17, 19, 21, 22		717

## 4300M / 4300A

6-point Deep Sockets  
6-kant Steckschlüssel, lang  
Douilles longues, 6-pans

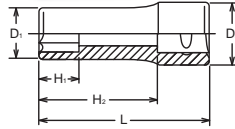

4300M 4305M (mm)	D <sub>1</sub> (mm)	D <sub>2</sub> (mm)	H <sub>1</sub> (mm)	H <sub>2</sub> (mm)	L (mm)	(g)	(pcs.)
8	13.2	21	9	59	77	76	10
9	13.8	21	10	59	77	82	10
10	15.3	21	11	59	77	82	10
11	16.5	21	12	59	77	86	10
12	17.8	21	13	59	77	92	10
13	19	21.8	14	59	77	106	10
14	20.3	21.8	15	59	77	115	10
15	21.5	21.8	16	59	77	123	10
16	22.8	22	17	59	77	141	10
17	24	23	18	59	77	139	10
18	25	24	19	59	77	149	10
19	26.5	25	20	58	77	165	10
20	27.8	26	21	58	77	183	10
21	29	27	23	58	77	190	10
22	30	28	27	57	77	200	10
23	31.5	29	27	57	77	233	10
24	32.8	30	27	57	77	249	10
25	34	31	27	57	77	270	10
26	35	32	27	56	77	279	10
27	36.5	33	28	56	77	303	10
28	37.8	34	28	56	77	331	10
29	39	35	28	55	77	357	10
30	40	36	34	55	77	342	10
31	41.5	37	34	55	77	384	10
32	42.8	38	34	55	77	405	10
33	44.2	39	35	54	77	420	5
34	45.2	40	35	54	77	442	5
35	46.2	40	35	53	77	458	5
36	47.2	41	35	53	77	484	5
37	48.2	42	38	53	77	475	5
38	49	44	38	53	77	490	5

## 4305M / 4305A

12-point Deep Sockets  
12-kant Steckschlüssel, lang  
Douilles longues, 12-pans

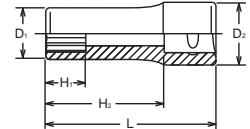

4300A 4305A (inch)	D <sub>1</sub> (mm)	D <sub>2</sub> (mm)	H <sub>1</sub> (mm)	H <sub>2</sub> (mm)	L (mm)	(g)	(pcs.)
5/16	13.2	21	9	59	77	76	10
3/8	14.6	21	10	59	77	82	10
7/16	16.5	21	12	59	77	86	10
1/2	19	21.8	14	59	77	106	10
9/16	20.3	21.8	15	59	77	115	10
19/32	21.5	21.8	16	59	77	123	10
5/8	22.8	22	17	59	77	141	10
21/32	24	23	18	59	77	139	10
11/16	25	24	19	59	77	149	10
3/4	26.5	25	20	58	77	165	10
25/32	27.8	26	21	58	77	183	10
13/16	29	27	23	58	77	190	10
7/8	30	28	27	57	77	200	10
15/16	32.8	30	27	57	77	249	10
31/32	34	31	27	57	77	270	10
1	35	32	27	56	77	279	10
1. 1/16	36.5	33	28	56	77	303	10
1. 1/8	37.8	34	28	56	77	331	10
1. 3/16	40	36	34	55	77	342	10
1. 1/4	42.8	38	34	55	77	405	10
1. 5/16	44.2	39	35	54	77	420	5
1. 3/8	46.2	40	35	54	77	422	5
1. 7/16	47.2	41	35	53	77	484	5
1. 1/2	49	44	38	53	77	523	5
1.13/16	59	48	38	51	77	791	5

RS4300M/10	10 Pieces Set/Rail 300mm	(g)
10, 11, 12, 13, 14, 15, 17, 19, 21, 22		1,415

RS4305M/10	10 Pieces Set/Rail 300mm	(g)
10, 11, 12, 13, 14, 15, 17, 19, 21, 22		1,415

RS4300M /12	12 Pieces Set/Rail 300mm	(g)
10, 12, 13, 14, 15, 16, 17, 18, 19, 20, 21, 22		1,825

RS4300A/10	10 Pieces Set/Rail 300mm	(g)
3/8, 7/16, 1/2, 9/16, 5/8, 11/16, 3/4, 13/16, 7/8, 15/16		1,600

RS4305A/10	10 Pieces Set/Rail 300mm	(g)
3/8, 7/16, 1/2, 9/16, 5/8, 11/16, 3/4, 13/16, 7/8, 15/16		1,600

## RS4300M/10



Socket Set on Rail  
Steckschlüsselsatz auf Schiene  
Jeu de douilles sur rail

## RS4305M/10



## RS4300M/12



Socket Set on Rail  
Steckschlüsselsatz auf Schiene  
Jeu de douilles sur rail



## RS4300A/10



Socket Set on Rail  
Steckschlüsselsatz auf Schiene  
Jeu de douilles sur rail

## RS4305A/10



# Hand Sockets Hand Steckschlüssel Douilles à main

# 1/2"

Z-SERIES  
HAND  
TITANIUM  
SCREWDRIVERS ACCESSORIES  
IMPACT  
SLEEVE-DRIVE  
PROTECTOR  
INDUSTRIAL  
AUTOMOTIVE  
CONSTRUCTION MOTORCYCLE  
SPARE PART

## 4310M

Surface Drive Deep Sockets  
Surface Drive Steckschlüssel, lang  
Douilles longues, Surface Drive

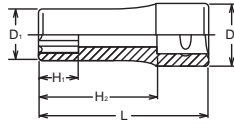
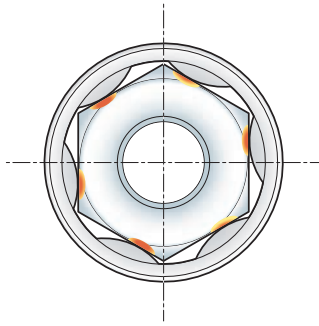

4310M (mm)	D <sub>1</sub> (mm)	D <sub>2</sub> (mm)	H <sub>1</sub> (mm)	H <sub>2</sub> (mm)	L (mm)	(g)	(pcs.)
8	13.2	21	9	59	77	79	10
9	13.8	21	10	59	77	82	10
10	15.3	21	11	59	77	82	10
11	16.5	21	12	59	77	86	10
12	17.8	21	13	59	77	92	10
13	19	21.8	14	59	77	106	10
14	20.3	21.8	15	59	77	115	10
15	21.5	21.8	16	59	77	123	10
16	22.8	22	17	59	77	141	10
17	24	23	18	59	77	139	10
18	25	24	19	59	77	149	10
19	26.5	25	20	58	77	165	10
20	27.8	26	21	58	77	183	10
21	29	27	23	58	77	190	10
22	30	28	27	57	77	200	10
23	31.5	29	27	57	77	233	10
24	32.8	30	27	57	77	249	10
25	34	31	27	57	77	270	10
26	35	32	27	56	77	279	10
27	36.5	33	28	56	77	303	10
28	37.8	34	28	56	77	334	10
29	39	35	28	55	77	357	10
30	40	36	34	55	77	342	10
31	41.5	37	34	55	77	384	10
32	42.8	38	34	55	77	405	10
34	45.2	40	35	54	77	442	5

## RS4310M/10

Socket Set on Rail  
Steckschlüsselsatz auf Schiene  
Jeu de douilles sur rail



RS4310M/10	10 Pieces Set/Rail 300mm	(g)
10, 11, 12, 13, 14, 15, 17, 19, 21, 22		1,415

## 4325

TORX® Deep Sockets  
TORX® Steckschlüssel, lang  
Douilles longues TORX®

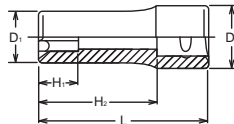

4325 (E)	D <sub>1</sub> (mm)	D <sub>2</sub> (mm)	H <sub>1</sub> (mm)	H <sub>2</sub> (mm)	L (mm)	(g)	(pcs.)
E 8	10.7	21	7	59	77	68	10
E10	13.2	21	8.2	59	77	99	10
E11	13.8	21	8.7	59	77	84	10
E12	14.6	21	9.3	59	77	99	10
E14	16.5	21	10.6	59	77	103	10
E16	19	21.8	11.8	59	77	107	10
E18	20.3	21.8	13	59	77	118	10
E20	22.8	22	14.4	59	77	141	10
E22	25	24	15.5	59	77	188	10
E24	26.6	25	17	59	77	215	10

## RS4325/7

Socket Set on Rail  
Steckschlüsselsatz auf Schiene  
Jeu de douilles sur rail



RS4325/7	7 Pieces Set/Rail 200mm	(g)
E10, E12, E14, E16, E18, E20, E24		900

### TORX® (E)

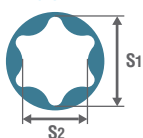

E	E4	E5	E6	E7	E8	E10	E11	E12	E14	E16	E18	E20	E22	E24	E26	E28	E30	E32
S <sub>1</sub> (ref. mm)	3.7	4.6	5.6	6.1	7.4	9.3	9.9	11.0	12.8	14.6	16.5	18.3	20.1	22.0	23.7	25.5	27.3	29.0
S <sub>2</sub> (ref. mm)	2.7	3.3	4.0	4.3	5.3	6.8	7.1	7.9	9.2	10.5	11.9	13.2	14.8	15.7	17.5	18.3	20.0	21.3

4300M(L120) (mm)	D <sub>1</sub> (mm)	D <sub>2</sub> (mm)	H <sub>1</sub> (mm)	H <sub>2</sub> (mm)	L (mm)	(g)	(pcs.)
8	13.2	21	9	102	120	120	5
10	15.3	21	11	102	120	138	5
12	17.8	21	13	102	120	157	5
14	20.3	21.8	15	102	120	193	5
16	22.8	22	17	102	120	210	5

## 4300M (L120) 6-point Extra Deep Sockets 6-kant Steckschlüssel, extra lang Douilles extra longues 6-pans

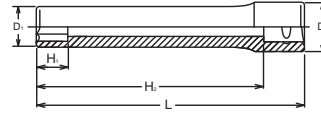

4325(L140) (E)	D <sub>1</sub> (mm)	D <sub>2</sub> (mm)	H <sub>1</sub> (mm)	H <sub>2</sub> (mm)	L (mm)	(g)	(pcs.)
E 8	10.7	21	7	122	140	110	5
E10	13.2	21	8.2	122	140	140	5
E12	14.6	21	9.3	122	140	160	5
E14	16.5	21	10.6	122	140	180	5

## 4325 (L140) TORX® Extra Deep Sockets TORX® Steckschlüssel, extra lang Douilles extra longues TORX®

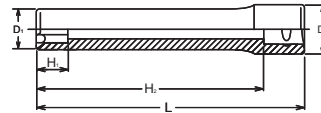

4325(L140) (E)	D <sub>1</sub> (mm)	D <sub>2</sub> (mm)	H <sub>1</sub> (mm)	H <sub>2</sub> (mm)	L (mm)	(g)	(pcs.)
E 8(2B)	10.7	21	6.6	122	140	110	5
E10(2B)	13.2	21	7.4	122	140	140	5
E12(2B)	14.6	21	9	122	140	160	5
E14(2B)	16.5	21	9.8	122	140	180	5

For Cylinder head bolt



## 4325 (L140)-2B TORX® Sockets Nut Grip® TORX® Steckschlüssel mit 2-facher Kugelhalterung Douilles TORX® à deux billes de retenue

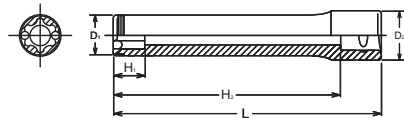

## 4117M-125 / -250 Extended Sockets Schaftsteckschlüssel Douilles rallongées

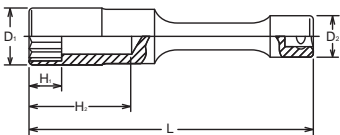

4117M-125 (mm)	D <sub>1</sub> (mm)	D <sub>2</sub> (mm)	H <sub>1</sub> (mm)	H <sub>2</sub> (mm)	L (mm)	(g)	(pce.)
13	18.7	24	13	59	125	213	1
14	20.2	24	14	59	125	227	1
17	24	24	17	59	125	274	1
19	26.9	24	19	59	125	279	1
21	28.5	24	21	59	125	291	1
22	30	24	22	59	125	323	1
24	32	24	24	59	125	361	1
27	36.5	24	27	59	125	439	1
30	40	24	30	59	125	461	1
32	42	24	32	59	125	498	1

4117M-250 (mm)	D <sub>1</sub> (mm)	D <sub>2</sub> (mm)	H <sub>1</sub> (mm)	H <sub>2</sub> (mm)	L (mm)	(g)	(pce.)
13	18.7	24	13	59	250	412	1
14	20.2	24	14	59	250	423	1
17	24	24	17	59	250	469	1
19	26.9	24	19	59	250	484	1
21	28.5	24	21	59	250	496	1
22	30	24	22	59	250	516	1
24	32	24	24	59	250	560	1
27	36.5	24	27	59	250	641	1
30	40	24	30	59	250	663	1
32	42	24	32	59	250	698	1

Z-SERIES  
HAND  
TITANIUM  
SCREWDRIVERS  
ACCESSORIES  
IMPACT  
SLEEVE-DRIVE  
PROTECTOR  
INDUSTRIAL  
AUTOMOTIVE  
CONSTRUCTION  
MOTORCYCLE  
SPARE PART

## 4440M / 4440A 6-point Universal Sockets 6-kant Gelenk-Einsätze Douilles articulées, 6-pans

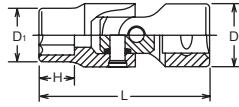

4440A (inch)	D <sub>1</sub> (mm)	D <sub>2</sub> (mm)	H (mm)	L (mm)	(g)	(pcs.)
3/8	14.8	25	8.8	63	155	10
7/16	16.5	25	10	65	158	10
1/2	19	25	11.4	66	152	10
9/16	20.3	25	11.4	66	151	10
5/8	22.8	25	13	68	150	10
11/16	24.6	25	14	69	153	10
3/4	26.5	25	15	71	170	10
7/8	30.3	25	16	72	185	5

4440M (mm)	D <sub>1</sub> (mm)	D <sub>2</sub> (mm)	H (mm)	L (mm)	(g)	(pcs.)
9	14	25	8.3	63	150	10
10	15.3	25	8.8	63	155	10
11	16.5	25	10	65	158	10
12	17.8	25	10.5	65	151	10
13	19	25	11.4	66	152	10
14	20.3	25	11.4	66	151	10
15	21.5	25	13	68	149	10
16	22.8	25	13	68	150	10
17	24	25	14	69	150	10
18	25.3	25	14	69	150	10
19	26.5	25	15	71	170	10
20	27.8	25	15	71	173	5
21	29	25	16	72	176	5
22	30.3	25	16	72	185	5

## 4445M / 4445A 12-point Universal Sockets 12-kant Gelenk-Einsätze Douilles articulées, 12-pans

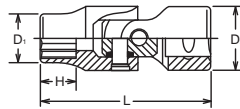

4445A (inch)	D <sub>1</sub> (mm)	D <sub>2</sub> (mm)	H (mm)	L (mm)	(g)	(pcs.)
3/8	14.8	25	8.8	63	155	10
7/16	16.5	25	10	65	158	10
1/2	19	25	11.4	66	152	10
9/16	20.3	25	11.4	66	151	10
5/8	22.8	25	13	68	150	10
11/16	24.6	25	14	69	153	10

4445M (mm)	D <sub>1</sub> (mm)	D <sub>2</sub> (mm)	H (mm)	L (mm)	(g)	(pcs.)
New 10	15.3	25	8.8	63	155	10
New 12	17.8	25	10.5	65	151	10
New 13	19	25	11.4	66	152	10
New 14	20.3	25	11.4	66	151	10
New 17	24	25	14	69	150	10
New 19	26.5	25	15	71	170	10
New 21	29	25	16	72	176	5
New 22	30.3	25	16	72	185	5

## 4440T TORX® Universal Sockets TORX® Gelenk-Einsätze Douilles articulées, TORX®

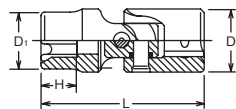

4440T (E)	D <sub>1</sub> (mm)	D <sub>2</sub> (mm)	H (mm)	L (mm)	(g)	(pcs.)
E10	13.2	25	8.2	62	145	10
E12	15	25	9.3	63	147	10
E14	16.3	25	10.6	65	148	10
E16	18.8	25	11.8	65	150	10
E18	20.4	25	13	67	153	10

## 4000-60 (PH) Phillips Bit Sockets Steckschlüssel für Kreuzschlitzschrauben, Phillips Douilles tournevis pour vis à empreinte Phillips

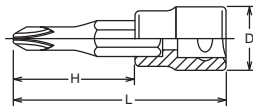

4000 (PH)	D (mm)	H (mm)	L (mm)	(g)	(pcs.)
2	22	23.5	60	65	10
3	22	23.5	60	65	10
4	22	23.5	60	67	10

## 4000-60 (PZ) PZ Bit Sockets Steckschlüssel für Kreuzschlitzschrauben, PZ Douilles tournevis pour vis à empreinte PZ

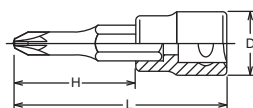

4000-60 (PZ)	D (mm)	H (mm)	L (mm)	(g)	(pcs.)
PZ2	22	23.5	60	65	10
PZ3	22	23.5	60	65	10

## 4005-60 Bit Sockets for Slotted Heads Steckschlüssel für Schlitzschrauben Douilles tournevis pour vis à fente

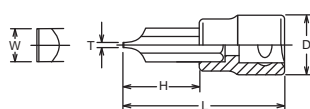



4005	TxW (mm)	D (mm)	H (mm)	L (mm)	(g)	(pcs.)
8	1.2x 8	22	23.5	60	65	10
10	1.6x10	22	23.5	60	75	10
12	2.0x12	23	23.5	60	111	10
14	2.5x14	24	23.5	60	133	10
16	2.5x16	24	23.5	60	133	10

# 1/2"

Hand Sockets  
Hand Steckschlüssel  
Douilles à main

## 4010M-50 / -75 / -100 / -160 4010A-60

 Inhex Bit Sockets  
Steckschlüssel für Innesechskant-Schrauben  
 Douilles tournevis pour vis 6-pans creux

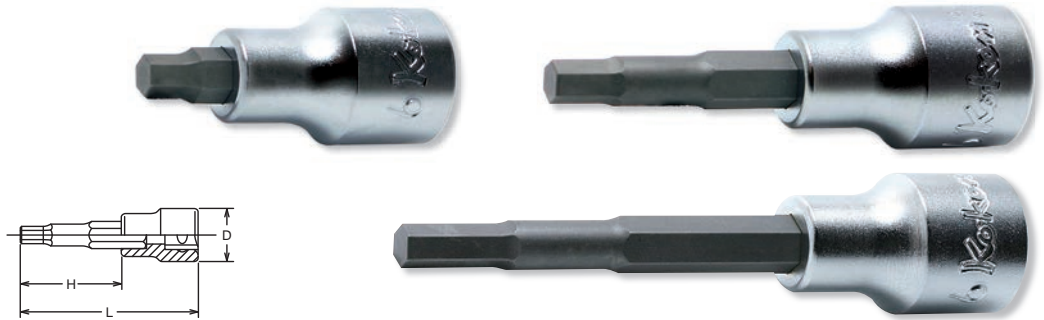

4010M-50 (mm)	D (mm)	H (mm)	L (mm)	(g)	(pcs.)
4	22	13.5	50	61	10
5	22	13.5	50	62	10
6	22	13.5	50	64	10
7	22	13.5	50	65	10
8	22	13.5	50	66	10
9	22	13.5	50	73	10
10	22	13.5	50	75	10
12	23	13.5	50	105	10
13	24	13.5	50	120	10
14	24	13.5	50	120	10
16	25	15	50	150	10
17	25	15	50	150	10
18	27	15	50	200	5
19	27	15	50	200	5

4010M-75 (mm)	D (mm)	H (mm)	L (mm)	(g)	(pcs.)
4	22	38.5	75	69	10
5	22	38.5	75	70	10
6	22	38.5	75	72	10
7	22	38.5	75	73	10
8	22	38.5	75	74	10
9	22	38.5	75	90	10
10	22	38.5	75	92	10
12	23	38.5	75	130	10
13	24	38.5	75	150	10
14	24	38.5	75	150	10
16	25	35	75	180	10
17	25	35	75	180	10
18	27	33	75	230	5
19	27	33	75	230	5

4010M-100 (mm)	D (mm)	H (mm)	L (mm)	(g)	(pcs.)
4	22	63.5	100	77	10
5	22	63.5	100	78	10
6	22	63.5	100	80	10
7	22	63.5	100	82	10
8	22	63.5	100	84	10
9	22	63.5	100	105	10
10	22	63.5	100	109	10
12	23	63.5	100	155	10
13	24	63.5	100	180	5
14	24	63.5	100	180	5
16	25	60	100	250	5
17	25	60	100	250	5
18	27	58	100	300	5
19	27	58	100	300	5

4010M-160 (mm)	D (mm)	H (mm)	L (mm)	(g)	(pcs.)
4	22	123.5	160	103	10
5	22	123.5	160	104	10
6	22	123.5	160	106	10
7	22	123.5	160	108	10
8	22	123.5	160	110	10
10	22	123.5	160	126	10
12	23	123.5	160	180	5
14	24	123.5	160	260	5
17	25	120	160	360	5
19	27	118	160	415	5



4010A-60 (inch)	D (mm)	H (mm)	L (mm)	(g)	(pcs.)
5/32	22	23.5	60	57	10
3/16	22	23.5	60	57	10
7/32	22	23.5	60	59	10
1/4	22	23.5	60	63	10
9/32	22	23.5	60	65	10
5/16	22	23.5	60	67	10
11/32	22	23.5	60	75	10
3/8	22	23.5	60	76	10
7/16	23	23.5	60	101	10
1/2	24	23.5	60	124	10
9/16	25	20	60	127	10
5/8	25	20	60	174	10
3/4	27	18	60	220	5



RS4010M/10-L50	10 Pieces Set/Rail 300mm	(g)
4, 5, 6, 7, 8, 10, 12, 14, 17, 19		968

RS4010M/10-L75	10 Pieces Set/Rail 300mm	(g)
4, 5, 6, 7, 8, 10, 12, 14, 17, 19		1,207

RS4010A/10-L60	10 Pieces Set/Rail 300mm	(g)
3/16, 7/32, 1/4, 5/16, 3/8, 7/16, 1/2, 9/16, 5/8, 3/4		1,080

**RS4010M/10-L50**  Socket Set on Rail  
Steckschlüsselsatz auf Schiene  
**RS4010M/10-L75**  Jeu de douilles sur rail  
**RS4010A/10-L60** 



# Hand Sockets Hand Steckschlüssel Douilles à main

## 1/2"

### 4012M-43 / -60 / -75 / -100



Inhex Sockets  
Steckschlüssel für Innensechskant-Schrauben  
Douilles tournevis pour vis 6-pans creux

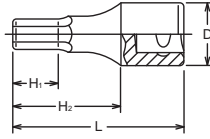

4012M-43 (mm)	D (mm)	H <sub>1</sub> (mm)	H <sub>2</sub> (mm)	L (mm)	(g)	(pcs.)
4	21.1	11.5	23	43	40	10
5	21.1	11.5	23	43	46	10
6	21.1	11.5	23	43	42	10
7	21.1	11.5	23	43	46	10
8	21.1	11.5	23	43	49	10
9	21.1	11.5	23	43	63	10
10	23	11.5	23	43	63	10
11	25	11.5	23	43	74	10
12	25	11.5	23	43	81	10
13	25	11.5	23	43	85	10
14	25	11.5	23	43	88	10
15	26	11.5	23	43	91	10
16	26	11.5	23	43	100	10
17	26	11.5	23	43	101	10
18	26	11.5	23	43	106	10
19	26	11.5	23	43	110	10
20	26	11.5	23	43	130	10
21	26	11.5	23	43	140	10
22	26	11.5	23	43	145	10
23	28	11.5	23	43	167	10
24	28	11.5	23	43	170	10
27	32	11.5	23	43	226	10

4012M-60 (mm)	D (mm)	H <sub>1</sub> (mm)	H <sub>2</sub> (mm)	L (mm)	(g)	(pcs.)
4	21.1	15.5	38	60	49	10
5	21.1	15.5	38	60	55	10
6	21.1	15.5	38	60	56	10
7	21.1	15.5	38	60	60	10
8	21.1	15.5	38	60	64	10
9	21.1	15.5	38	60	78	10
10	23	15.5	38	60	78	10
11	25	15.5	38	60	100	10
12	25	15.5	38	60	107	10
13	25	15.5	38	60	111	10
14	25	15.5	38	60	122	10
15	26	15.5	38	60	125	10
16	26	15.5	38	60	134	10
17	26	15.5	38	60	141	10
18	26	15.5	38	60	153	10
19	26	15.5	38	60	159	10
21	26	15.5	38	60	197	10
22	26	22.5	38	60	205	10
23	28	22.5	38	60	242	10
24	28	22.5	38	60	245	10

4012M-75 (mm)	D (mm)	H <sub>1</sub> (mm)	H <sub>2</sub> (mm)	L (mm)	(g)	(pcs.)
4	21.1	15.5	53	75	52	10
5	21.1	15.5	53	75	58	10
6	21.1	15.5	53	75	62	10
7	21.1	15.5	53	75	70	10
8	21.1	15.5	53	75	74	10
9	21.1	15.5	53	75	88	10
10	23	15.5	53	75	94	10
11	25	15.5	53	75	119	10
12	25	15.5	53	75	122	10
13	25	15.5	53	75	137	10
14	25	15.5	53	75	148	10
15	26	15.5	53	75	151	10
16	26	15.5	53	75	171	10
17	26	15.5	53	75	184	10
18	26	15.5	53	75	196	10
19	26	15.5	53	75	212	10
22	26	22.5	53	75	266	10
24	27.9	22.5	53	75	315	10

4012M-100 (mm)	D (mm)	H <sub>1</sub> (mm)	H <sub>2</sub> (mm)	L (mm)	(g)	(pcs.)
4	24	15.5	78	100	75	10
5	24	15.5	78	100	81	10
6	24	15.5	78	100	85	10
7	24	15.5	78	100	93	10
8	24	15.5	78	100	97	10
9	24	15.5	78	100	111	10
10	24	15.5	78	100	117	10
11	24	15.5	78	100	142	10
12	24	15.5	78	100	143	10
13	24	15.5	78	100	158	10
14	24	15.5	78	100	169	10
15	24	15.5	78	100	172	10
16	24	15.5	78	100	192	5
17	24	15.5	78	100	215	5
18	24	15.5	78	100	227	5
19	24	15.5	78	100	243	5

### RS4012M/10-L60



Socket Set on Rail  
Steckschlüsselsatz auf Schiene  
Jeu de douilles sur rail





RS4012M/10-L60	10 Pieces set/Rail 300mm	(g)
4, 5, 6, 7, 8, 10, 12, 14, 17, 19		910

4012M/A are for hand use only.  
Do not use with a power or impact wrench.  
Nicht auf Maschinenschrauben verwenden.  
À ne pas utiliser sur des machines



## 4012A-43 / -60 / -75 / -100

 Inhex Sockets  
Steckschlüssel für Innensechskant-Schrauben   
Douilles tournevis pour vis 6-pans creux

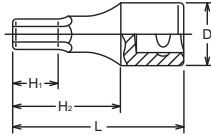

4012A-43 (inch)	D (mm)	H <sub>1</sub> (mm)	H <sub>2</sub> (mm)	L (mm)	(g)	(pcs.)
5/32	21.1	11.5	23	43	40	10
3/16	21.1	11.5	23	43	46	10
7/32	21.1	11.5	23	43	42	10
1/4	21.1	11.5	23	43	43	10
9/32	21.1	11.5	23	43	46	10
5/16	21.1	11.5	23	43	49	10
11/32	21.1	11.5	23	43	63	10
3/8	23	11.5	23	43	59	10
7/16	25	11.5	23	43	74	10
1/2	25	11.5	23	43	85	10
9/16	25	11.5	23	43	88	10
5/8	26	11.5	23	43	100	10
3/4	26	11.5	23	43	110	10
7/8	26	11.5	23	43	141	10

4012A-60 (inch)	D (mm)	H <sub>1</sub> (mm)	H <sub>2</sub> (mm)	L (mm)	(g)	(pcs.)
5/32	21.1	15.5	38	60	49	10
3/16	21.1	15.5	38	60	55	10
7/32	21.1	15.5	38	60	56	10
1/4	21.1	15.5	38	60	57	10
9/32	21.1	15.5	38	60	60	10
5/16	21.1	15.5	38	60	64	10
11/32	21.1	15.5	38	60	78	10
3/8	23	15.5	38	60	74	10
7/16	25	15.5	38	60	100	10
1/2	25	15.5	38	60	111	10
9/16	25	15.5	38	60	122	10
5/8	26	15.5	38	60	134	10
3/4	26	15.5	38	60	159	10
7/8	26	22.5	38	60	202	10

4012A-75 (inch)	D (mm)	H <sub>1</sub> (mm)	H <sub>2</sub> (mm)	L (mm)	(g)	(pcs.)
5/32	21.1	15.5	53	75	52	10
3/16	21.1	15.5	53	75	58	10
7/32	21.1	15.5	53	75	62	10
1/4	21.1	15.5	53	75	65	10
9/32	21.1	15.5	53	75	70	10
5/16	21.1	15.5	53	75	74	10
11/32	21.1	15.5	53	75	88	10
3/8	23	15.5	53	75	86	10
7/16	25	15.5	53	75	119	10
1/2	25	15.5	53	75	137	10
9/16	25	15.5	53	75	148	10
5/8	26	15.5	53	75	171	10
3/4	26	15.5	53	75	212	10
7/8	26	22.5	53	75	262	10

4012A-100 (inch)	D (mm)	H <sub>1</sub> (mm)	H <sub>2</sub> (mm)	L (mm)	(g)	(pcs.)
5/32	24	15.5	78	100	75	10
3/16	24	15.5	78	100	81	10
7/32	24	15.5	78	100	85	10
1/4	24	15.5	78	100	88	10
9/32	24	15.5	78	100	93	10
5/16	24	15.5	78	100	97	10
11/32	24	15.5	78	100	111	10
3/8	24	15.5	78	100	109	10
7/16	24	15.5	78	100	142	10
1/2	24	15.5	78	100	158	10
9/16	24	15.5	78	100	169	10
5/8	24	15.5	78	100	192	5
3/4	24	15.5	78	100	243	5

RS4012A/10-L60	10 Pieces set/Rail 300mm	(g)
3/16, 7/32, 1/4, 5/16, 3/8, 7/16, 1/2, 9/16, 5/8, 3/4		950

**RS4012A/10-L60**   Socket Set on Rail  
Steckschlüsselsatz auf Schiene  
Jeu de douilles sur rail



 4012M/A are for hand use only.  
Do not use with a power or impact wrench.  
Nicht auf Maschinenschrauben verwenden.  
À ne pas utiliser sur des machines

# Hand Sockets Hand Steckschlüssel Douilles à main

# 1/2"

Z-SERIES  
HAND  
TITANIUM  
SCREWDRIVERS ACCESSORIES  
IMPACT  
SLEEVE-DRIVE  
PROTECTOR  
INDUSTRIAL  
AUTOMOTIVE  
CONSTRUCTION MOTORCYCLE  
SPARE PART

## 4020-60 / -100 / -120 / -140

XZN Bit Sockets  
Steckschlüssel für XZN Schrauben  
Douilles tournevis pour empreinte XZN

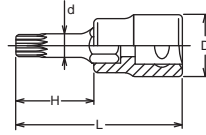
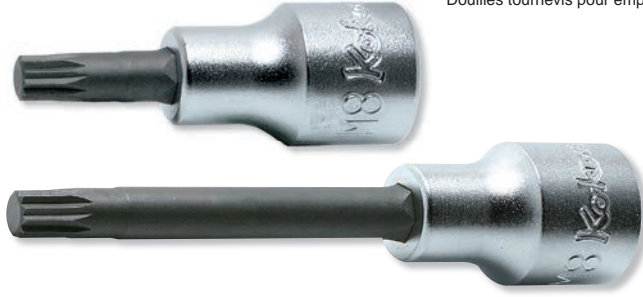

4020-60 (XZN)	D (mm)	d (mm)	H (mm)	L (mm)	(g)	(pcs.)
M 5	22	7.8	23.5	60	60	10
M 6	22	7.8	23.5	60	61	10
M 8	22	7.8	23.5	60	63	10
M10	23	11.9	23.5	60	93	10
M12	23	11.9	23.5	60	97	10
M14	24	13.9	23.5	60	105	10
M16	25	16.9	20	60	165	10
M18	27	17.9	20	60	215	5

4020-120 (XZN)	D (mm)	d (mm)	H (mm)	L (mm)	(g)	(pcs.)
M 5	22	7.8	83.5	120	86	10
M 6	22	7.8	83.5	120	87	10
M 8	22	7.8	83.5	120	89	10
M10	23	11.9	83.5	120	152	10
M12	23	11.9	83.5	120	156	10
M14	24	13.9	83.5	120	164	5

4020-100 (XZN)	D (mm)	d (mm)	H (mm)	L (mm)	(g)	(pcs.)
M 5	22	7.8	63.5	100	77	10
M 6	22	7.8	63.5	100	78	10
M 8	22	7.8	63.5	100	80	10
M10	23	11.9	63.5	100	132	10
M12	23	11.9	63.5	100	136	10
M14	24	13.9	63.5	100	144	5
M16	25	16.9	60	100	250	5
M18	27	17.9	60	100	300	5

4020-140 (XZN)	D (mm)	d (mm)	H (mm)	L (mm)	(g)	(pcs.)
M 5	22	7.8	103.5	140	95	10
M 6	22	7.8	103.5	140	96	10
M 8	22	7.8	103.5	140	98	10
M10	23	11.9	103.5	140	172	5
M12	23	11.9	103.5	140	176	5
M14	24	13.9	103.5	140	184	5

## RS4020/6-L60 RS4020/6-L100

Socket Set on Rail  
Steckschlüsselsatz auf Schiene  
Jeu de douilles sur rail



RS4020/6-L60	6 Pieces Set/Rail 150mm	(g)
<b>M5, M6, M8, M10, M12, M14</b>		500

RS4020/6-L100	6 Pieces Set/Rail 150mm	(g)
<b>M5, M6, M8, M10, M12, M14</b>		680

### XZN

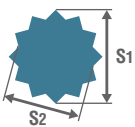

XZN		M4	M5	M6	M8	M10	M12	M14	M16	M18
S <sub>1</sub>	(ref. mm)	3.6	4.8	6.1	7.3	9.7	11.5	13.3	15.7	16.9
S <sub>2</sub>	(ref. mm)	3.1	4.1	5.1	6.1	8.1	9.7	11.2	13.2	14.2

	Phillips (PH)	PZ	Slotted	HEX	HEX (ball point)	Triple Square (XZN)	TORX® (T)	TORX® (TH)	TORXplus® (IP)	TORXplus® (IPR)	Ribe-CV
1/4"	No.2000 series	No.2000(PZ) series	No.2005 series	No.2010M/A series	No.2011M series	No.2020 series	No.2025 series	No.2025(TH) series	No.2025(IP) series	No.2025(IPR) series	—
3/8"	No.3000 series	No.3000(PZ) series	No.3005 series	No.3010M/A No.3012M/A No.3015M series	No.3011M series	No.3020 series	No.3025 series	No.3025(TH) series	No.3025(IP) series	No.3025(IPR) series	No.3027 series
1/2"	No.4000 series	No.4000(PZ) series	No.4005 series	No.4010M/A No.4012M/A series	—	No.4020 series	No.4025 series	—	No.4025(IP) series	—	No.4027 series

# 1/2"

Hand Sockets  
Hand Steckschlüssel  
Douilles à main

4025-60 (T)	D (mm)	H (mm)	L (mm)	(g)	(pcs.)
T15	22	23.5	60	58	10
T20	22	23.5	60	59	10
T25	22	23.5	60	60	10
T27	22	23.5	60	60	10
T30	22	23.5	60	60	10
T40	22	23.5	60	62	10
T45	22	23.5	60	64	10
T50	22	23.5	60	74	10
T55	23	23.5	60	96	10
T60	24	23.5	60	122	10
T70	24	23.5	60	135	10
T80	24	20	60	168	10

4025-100 (T)	D (mm)	H (mm)	L (mm)	(g)	(pcs.)
T20	22	73.5	100	76	10
T25	22	73.5	100	76	10
T27	22	73.5	100	77	10
T30	22	73.5	100	77	10
T40	22	73.5	100	78	10
T45	22	73.5	100	80	10
T50	22	73.5	100	98	10
T55	23	73.5	100	132	10
T60	24	73.5	100	170	5
T70	24	73.5	100	175	5

4025-140 (T)	D (mm)	H (mm)	L (mm)	(g)	(pcs.)
T20	22	103.5	140	94	10
T25	22	103.5	140	95	10
T27	22	103.5	140	95	10
T30	22	103.5	140	95	10
T40	22	103.5	140	97	10
T45	22	103.5	140	99	10
T50	22	103.5	140	129	10
T55	23	103.5	140	175	5
T60	24	103.5	140	229	5
T70	24	103.5	140	245	5
T80	24	100	140	320	5

RS4025/9-L60	9 Pieces Set/Rail 250mm	(g)
T20, T25, T27, T30, T40, T45, T50, T55, T60		700

## 4025-60 / -100 / -140 (T)

TORX® Bit Sockets  
TORX® Bit-Steckschlüssel  
Douilles tournevis, TORX®

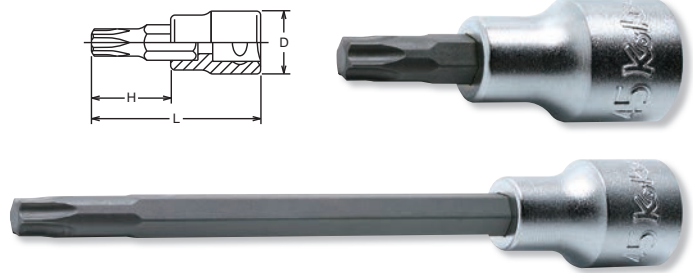

## RS4025/9-L60



Socket Set on Rail  
Steckschlüsselsatz auf Schiene  
Jeu de douilles sur rail



TORX®  
(T)

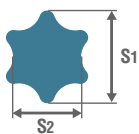

T	T8	T9	T10	T15	T20	T25	T27	T30	T40	T45	T50	T55	T60	T70	T80	T90	T100
S1 (ref. mm)	2.3	2.5	2.7	3.3	3.9	4.5	5.0	5.6	6.7	7.9	8.9	11.3	13.3	15.6	17.6	20.0	22.2
S2 (ref. mm)	1.7	1.8	2.0	2.3	2.8	3.2	3.6	4.0	4.8	5.6	6.2	8.0	9.5	11.1	12.7	14.2	15.8

4025-60	D (mm)	H (mm)	L (mm)	(g)	(pcs.)
T35	22	23.5	60	96	10

For T35 Special screws

## 4025-60-T35

Bit Socket  
Bit-Steckschlüssel  
Douille tournevis

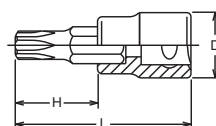

Z-SERIES  
HAND  
TITANIUM  
SCREWDRIVERS  
ACCESSORIES  
IMPACT  
SLEEVE-DRIVE  
PROTECTOR  
INDUSTRIAL  
AUTOMOTIVE  
CONSTRUCTION  
MOTORCYCLE  
SPARE PART

## 4025-60 / -100 (IP)



TORXPLUS® Bit Sockets  
TORXPLUS® Bit-Steckschlüssel  
Douilles tournevis, TORXPLUS®

**TORXplus**



4025-60 (IP)	D (mm)	H (mm)	L (mm)	(g)	(pcs.)
20IP	22	23.5	60	60	10
25IP	22	23.5	60	60	10
27IP	22	23.5	60	60	10
30IP	22	23.5	60	60	10
40IP	22	23.5	60	60	10
45IP	22	23.5	60	64	10
50IP	22	23.5	60	74	10
55IP	23	23.5	60	96	10
60IP	24	23.5	60	122	10
70IP	24	23.5	60	170	10

## RS4025/9-IP



Socket Set on Rail  
Steckschlüsselsatz auf Schiene  
Jeu de douilles sur rail



4025-100 (IP)	D (mm)	H (mm)	L (mm)	(g)	(pcs.)
40IP	22	63.5	100	79	10
45IP	22	63.5	100	81	10
50IP	22	63.5	100	100	10
55IP	23	63.5	100	133	10
60IP	24	63.5	100	172	5
70IP	25	63.5	100	241	5

RS4025/9-IP	9 Pieces set/Rail 250mm	(g)
20IP, 25IP, 27IP, 30IP, 40IP, 45IP, 50IP, 55IP, 60IP		700

### TORXPLUS® (IP)

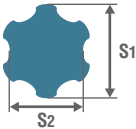

IP	8IP	9IP	10IP	15IP	20IP	25IP	27IP	30IP	40IP	45IP	50IP	55IP	60IP	70IP
S <sub>1</sub> (ref. mm)	2.3	2.5	2.7	3.3	3.9	4.5	5.0	5.6	6.7	7.9	8.9	11.3	13.3	15.6
S <sub>2</sub> (ref. mm)	1.7	1.8	2.0	2.3	2.8	3.2	3.6	4.0	4.8	5.6	6.2	8.0	9.5	11.1

## 4027-60 / -100 / -140



Bit Sockets for Ribe Screws  
Steckschlüsselklingen für Ribe Schrauben  
Douilles tournevis pour écrous profil Ribe

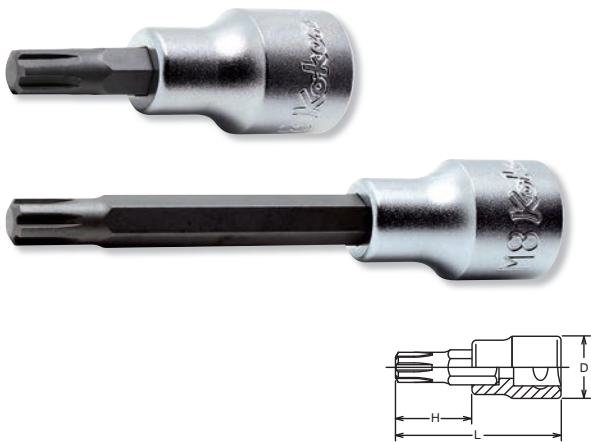

4027-60	D (mm)	H (mm)	L (mm)	(g)	(pcs.)
M 5	22	23.5	60	60	10
M 6	22	23.5	60	62	10
M 7	22	23.5	60	63	10
M 8	22	23.5	60	64	10
M 9	22	23.5	60	70	10
M10	22	23.5	60	74	10
M12	23	23.5	60	96	10
M13	24	23.5	60	116	10
M14	24	23.5	60	122	10
M16	24	25	60	135	10

4027-100	D (mm)	H (mm)	L (mm)	(g)	(pcs.)
M 5	22	63.5	100	67	10
M 6	22	63.5	100	68	10
M 7	22	63.5	100	75	10
M 8	22	63.5	100	81	10
M 9	22	63.5	100	90	10
M10	22	63.5	100	101	10
M12	23	63.5	100	134	10
M13	24	63.5	100	155	5
M14	24	63.5	100	173	5
M16	24	60	100	241	5

## RS4027/7-L60



Socket Set on Rail  
Steckschlüsselsatz auf Schiene  
Jeu de douilles sur rail



4027-140	D (mm)	H (mm)	L (mm)	(g)	(pcs.)
M 8	22	103.5	140	98	10
M10	22	103.5	140	127	10
M12	23	103.5	140	171	5
M14	24	103.5	140	226	5
M16	24	100	140	320	5

RS4027/7-L60	7 Pieces set/Rail 200mm	(g)
M5, M6, M8, M10, M12, M14, M16		600

### Ribe CV

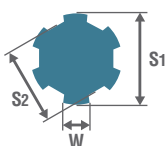

CV	M5	M6	M7	M8	M9	M10	M12	M13	M14	M16
W (ref. mm)	1.2	1.3	1.4	1.8	2.0	2.3	2.6	3.1	3.2	3.6
S <sub>1</sub> (ref. mm)	5.0	6.0	7.0	8.0	9.0	10.0	12.0	13.0	14.0	16.0
S <sub>2</sub> (ref. mm)	3.8	4.5	5.0	6.0	7.1	7.4	9.0	11.0	10.4	11.9

4110M (mm)	D (mm)	H (mm)	L (mm)	(g)	(pcs.)
8	24	10	32	57	10
10	24	10	32	62	10
10.5	24	10	32	64	10
12	24	10	32	64	10
13	24	10	32	66	10
13.5	24	10	32	67	10
19	25	15	37	101	10
20	26	15	37	114	10

4110A (inch)	D (mm)	H (mm)	L (mm)	(g)	(pcs.)
3/8	24	10	32	62	10
1/2	24	10	32	64	10

4101	TxW (mm)	D (mm)	L (mm)	(g)	(pcs.)
1	2.7x18.6	22	40	59	10
2	3.7x24	24	40	79	10
3	3.7x30	30	40	128	10

4137	D <sub>1</sub> (mm)	D <sub>2</sub> (mm)	L (mm)	(g)	(pcs.)
4137	13	22	38	53	10

For DIN3126 C6.3 Bits  
Für DIN3126 C6.3 Bits  
Pour DIN3126 C6.3 Embouts

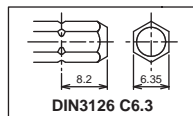

4138	D <sub>1</sub> (mm)	D <sub>2</sub> (mm)	L (mm)	(g)	(pcs.)
4138	16	22	38	62	10

For DIN3126 C8 Bits  
Für DIN3126 C8 Bits  
Pour DIN3126 C8 Embouts

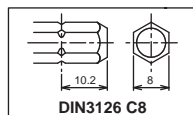

## 4110M / 4110A

4-point Male Sockets  
Öldienst-Steckschlüssel, Vierkant  
Douilles mâles 4-pans

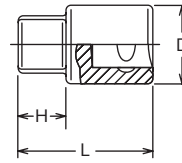

## 4101

Sockets for Slotted Heads  
Steckschlüssel für Schlitzschrauben  
Douilles tournevis pour vis à fente

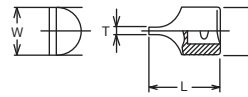

## 4137

Bit Holder  
Klingenhalter  
Porte-embouts

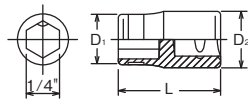

## 4138

Bit Holder  
Klingenhalter  
Porte-embouts

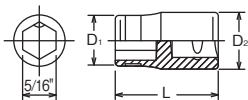

# Hand Sockets Hand Steckschlüssel Douilles à main

## 1/2"

Z-SERIES  
HAND  
TITANIUM  
SCREWDRIVERS ACCESSORIES  
IMPACT  
SLEEVE-DRIVE  
PROTECTOR  
INDUSTRIAL  
AUTOMOTIVE  
MOTORCYCLE  
CONSTRUCTION  
SPARE PART

**3749S-1/2** Reversible Ratchet Short  
Knarre, verstellbar  
Cliquet, réversible



\* Renewal Kits → 3749SRK-1/2 → P304

**3749SB-1/2** Reversible Ratchet short with quick release button  
Knarre, verstellbar mit Entriegelungsknopf  
Cliquet, réversible avec bouton de débrayage

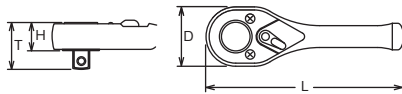

\* Renewal Kits → 3749SRK-1/2 → P304

	D (mm)	T (mm)	H (mm)	L (mm)	(g)	(pce.)
3749S-1/2	34	29	14.4	110	200	5
3749SB-1/2	34	29	14.4	110	200	5

⚠ Reversible Ratchet with quick release button has less strength compared with normal ratchet due to the technical design. Make sure to use the ratchet correctly.

**4752J** Reversible Ratchet  
Knarre, verstellbar  
Cliquet, réversible



\* Renewal Kits → 4752RK → P305

[L/R Marking]



A pointer and L/R markings on the ratchet head indicate the turning direction. The reduced diameter of the head allows easier access in tight spots.

Eine L/R Markierung auf dem Knarrenkopf zeigt die gerade eingestellte Drehrichtung an. Der geringe Kopfdurchmesser erleichtert das Arbeiten auch an schwer zugänglichen Stellen.

Un marquage L/R sur la tête de cliquet indique le sens de rotation. Le diamètre de tête réduit et facilite le travail dans les endroits difficilement accessibles.

**4752N** Reversible Ratchet  
Knarre, verstellbar  
Cliquet, réversible

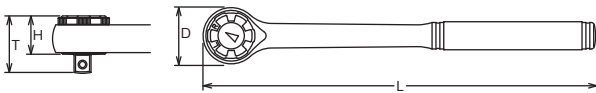

	D (mm)	T (mm)	H (mm)	L (mm)	(g)	(pce.)
4752J	35	38.8	24.5	250	470	1
4752N	35	38.8	24.5	250	480	1

## GEAR TEETH



4749series



4753series



4750series



4752series



4774series





\* Renewal Kits → 4750RK → P304

**4750J** Reversible Ratchet  
Knarre, verstellbar  
Cliquet, réversible



\* Renewal Kits → 4750RK → P304

**4750P** Reversible Ratchet  
Knarre, verstellbar  
Cliquet, réversible



\* Renewal Kits → 4750RK → P304

**4750N** Reversible Ratchet  
Knarre, verstellbar  
Cliquet, réversible



	D (mm)	T (mm)	H (mm)	L (mm)	(g)	(pce.)
4750J	38	35.9	21.3	250	508	1
4750P	38	35.9	21.3	250	553	1
4750N	38	35.9	21.3	250	548	1

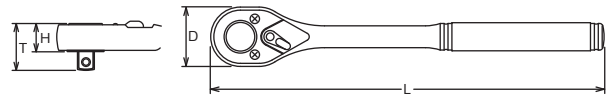

\* Renewal Kits → 4750BRK → P304

**4750JB** Reversible Ratchet with quick release button  
Knarre, verstellbar mit Entriegelungsknopf  
**4750PB** Cliquet, réversible avec bouton de débrayage ⚠  
**4750NB**



	D (mm)	T (mm)	H (mm)	L (mm)	(g)	(pce.)
4750JB	38	35.9	21.3	250	508	1
4750PB	38	35.9	21.3	250	553	1
4750NB	38	35.9	21.3	250	548	1

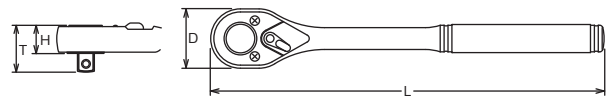

⚠ Reversible Ratchet with quick release button has less strength compared with normal ratchet due to the technical design. Make sure to use the ratchet correctly.

## [4750 series]

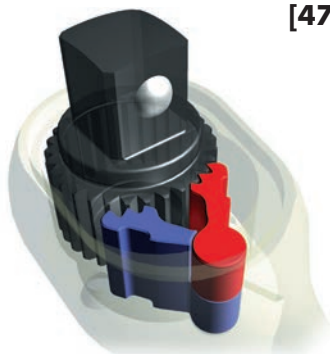

Two dogs are set in the same axis and the three teeth hold the ratchet gear. The enlarged contact area produces an about 10% higher torque value and the S.O.D.H system provides smooth and light movements.

Die scharnierartig eingelagerten Sperrklinken haben jetzt jeweils drei Zähne im Eingriff. Die dadurch vergrößerte Greiffläche erhöht das maximale Drehmoment um ca. 10%. Auch diese Knarre besticht durch ihren leichten und geschmeidigen Lauf.

Les deux rochets étant placés sur le même axe, les trois dents de l'engrenage sont engagées en permanence. Ce système assure une augmentation de 10% du couple maximum admissible. Ce cliquet se caractérise également par son fonctionnement souple et sans à-coup.

# Hand Sockets Hand Steckschlüssel Douilles à main

## 1/2"

Z-SERIES  
HAND  
TITANIUM  
SCREWDRIVERS ACCESSORIES  
IMPACT  
SLEEVE-DRIVE  
PROTECTOR  
INDUSTRIAL  
AUTOMOTIVE  
MOTORCYCLE  
CONSTRUCTION  
SPARE PART

**4753J** Reversible Ratchet  
Knarre, verstellbar  
Cliquet, réversible



\* Renewal Kits → 4753RK → P304

**4753P** Reversible Ratchet  
Knarre, verstellbar  
Cliquet, réversible



\* Renewal Kits → 4753RK → P304

**4753N** Reversible Ratchet  
Knarre, verstellbar  
Cliquet, réversible



\* Renewal Kits → 4753RK → P304

**D4753J** Reversible Ratchet  
Knarre, verstellbar  
Cliquet, réversible



\* Renewal Kits → 4753RK → P304

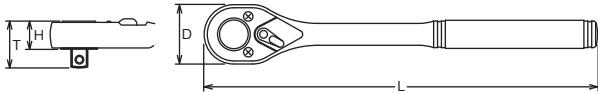

	D (mm)	T (mm)	H (mm)	L (mm)	(g)	(pce.)
4753J	38	36.2	21.6	250	545	1
4753P	38	36.2	21.6	250	570	1
4753N	38	36.2	21.6	250	595	1
D4753J	38	36.2	21.6	250	510	1

**4753JB** Reversible Ratchet with quick release button  
**4753PB** Knarre, verstellbar mit Entriegelungsknopf  
**4753NB** Cliquet, réversible avec bouton de débrayage



\* Renewal Kits → 4753BRK → P304

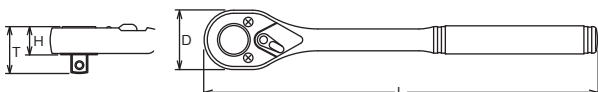

	D (mm)	T (mm)	H (mm)	L (mm)	(g)	(pce.)
4753JB	38	36.2	21.6	250	545	1
4753PB	38	36.2	21.6	250	570	1
4753NB	38	36.2	21.6	250	595	1

**⚠** Reversible Ratchet with quick release button has less strength compared with normal ratchet due to the technical design. Make sure to use the ratchet correctly.

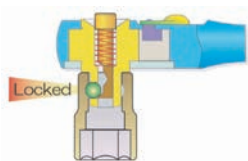

**Reversible Ratchet with Quick Release Button :**  
Sockets and accessories are safely locked. By pushing the button the sockets or extension bars are released from the ratchet.

**Umstellbare Knarre mit Entriegelungsknopf :**  
Steckschlüssel und Zubehörteile werden sicher und fest gehalten. Bei Drücken des Knopfes lösen sich die Teile.

**Cliquet réversible avec bouton de débrayage :**  
Les douilles et accessoires ne peuvent plus tomber. Une pression du pouce sur le bouton suffit pour les libérer.



# 1/2"

Hand Sockets  
Hand Steckschlüssel  
Douilles à main

Z-SERIES  
HAND  
TITANIUM  
ACCESSORIES  
SCREWDRIVERS  
IMPACT  
SLEEVE-DRIVE  
PROTECTOR  
INDUSTRIAL  
AUTOMOTIVE  
MOTORCYCLE  
CONSTRUCTION  
SPARE PART



\* Renewal Kits → 4749RK → P304

**4749J-380** Reversible Ratchet (long)  
**4749N-380** Verstellbare Knarre, lang  
Cliquet réversible, long



	D (mm)	T (mm)	H (mm)	L (mm)	(g)	(pce.)
4749J-380	44.6	33	18.4	380	743	1
4749N-380	44.6	33	18.4	380	753	1

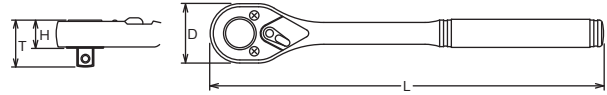

\* Renewal Kits → 4753RK → P304

**4753P-410** Reversible Ratchet (long) ⚠  
Verstellbare Knarre, lang  
Cliquet réversible, long



	D (mm)	T (mm)	H (mm)	L (mm)	(g)	(pce.)
4753P-410	38	36.2	21.6	410	790	1

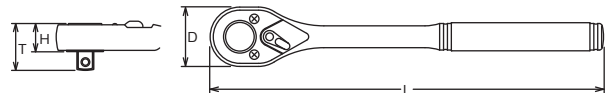

⚠ 4753P-410 have longer handle than standard, and can be loaded to excessive torque value. In the interest of your own safety always apply load evenly and progressively to avoid breakage and possible injury.



\* Renewal Kits → 4753RK → P304

**4774J** Flexible Ratchet, reversible  
**4774P** Gelenk-Knarre, verstellbar  
**4774N** Cliquet, articulé, réversible

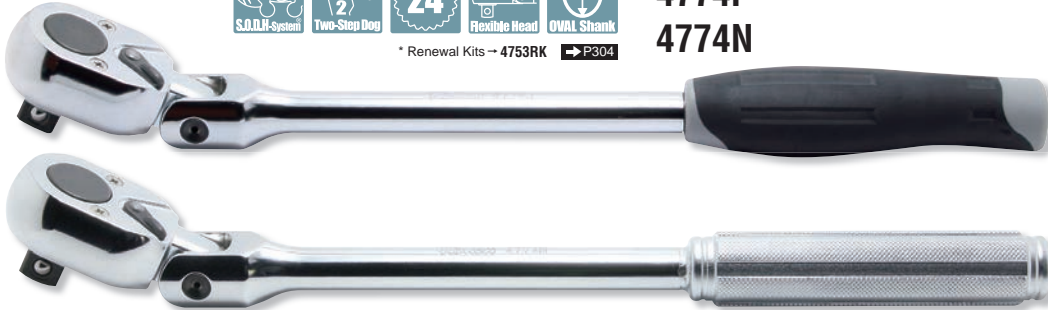

	D (mm)	T (mm)	H (mm)	L (mm)	(g)	(pce.)
4774J	38	36.2	21.6	330	685	1
4774P	38	36.2	21.6	330	700	1
4774N	38	36.2	21.6	330	700	1

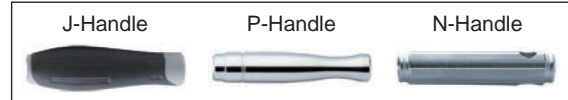
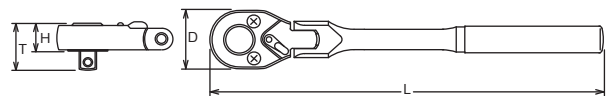

\* Renewal Kits → 4753RK → P304

**4774P-450** Flexible Ratchet, reversible ⚠  
Gelenk-Knarre, verstellbar  
Cliquet, articulé, réversible



	D (mm)	T (mm)	H (mm)	L (mm)	(g)	(pce.)
4774P-450	38	36.2	21.6	450	790	1

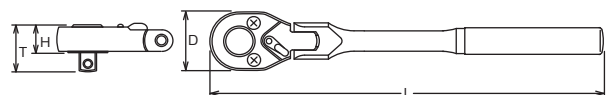

⚠ 4774P-450 has longer handle than standard, and can be loaded to excessive torque value. In the interest of your own safety always apply load evenly and progressively to avoid breakage and possible injury.

# Hand Sockets Hand Steckschlüssel Douilles à main

## 1/2"

Z-SERIES  
HAND  
TITANIUM  
SCREWDRIVERS ACCESSORIES  
IMPACT  
SLEEVE-DRIVE  
PROTECTOR  
INDUSTRIAL  
AUTOMOTIVE  
MOTORCYCLE  
CONSTRUCTION  
SPARE PART

**4774JB** Flexible Ratchet, reversible with quick release button   
**4774PB** Gelenk-Knarre, verstellbar mit Entriegelungsknopf  
**4774NB** Cliquet, articulé, réversible avec bouton de débrayage



\* Renewal Kits → 4753BRK → P304

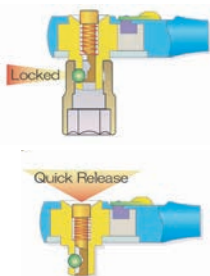
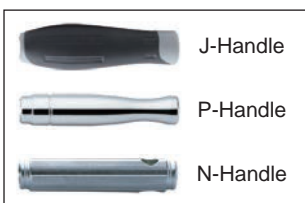
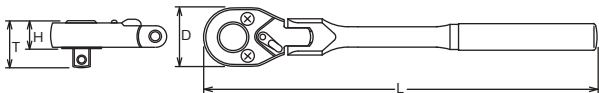

	D (mm)	T (mm)	H (mm)	L (mm)	(g)	(pce.)
4774JB	38	36.2	21.6	330	685	1
4774PB	38	36.2	21.6	330	700	1
4774NB	38	36.2	21.6	330	700	1

 Reversible Ratchet with quick release button has less strength compared with normal ratchet due to the technical design. Make sure to use the ratchet correctly.

**Reversible Ratchet with Quick Release Button :**  
Sockets and accessories are safely locked. By pushing the button the sockets or extension bars are released from the ratchet.

**Umstellbare Knarre mit Entriegelungsknopf :**  
Steckschlüssel und Zubehörteile werden sicher und fest gehalten. Bei Drücken des Knopfes lösen sich die Teile.

**Cliquet réversible avec bouton de débrayage :**  
Les douilles et accessoires ne peuvent plus se libérer. Une pression du pouce sur le bouton suffit pour les extraire.

**4755** Ratchet Adaptor  
Aufsteckknarre  
Cliquet adaptable

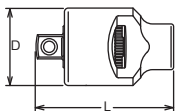

\* Renewal Kits → 4755RK → P305

	D (mm)	L (mm)	(g)	(pcs.)
4755	33.5	65	270	5

**4756** Quick Spinner  
Rändel-Drehscheibe  
Lanceur

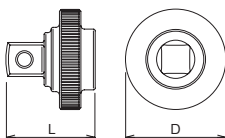

	D (mm)	L (mm)	(g)	(pcs.)
4756	38	34.5	95	10

**4768J-380 / -450** Hinge Handles  
Gelenkgriffe  
Poignées articulées 



\* Renewal Kits → 4768RK → P306



**4768P-380 / -450** Hinge Handles  
Gelenkgriffe  
Poignées articulées 



\* Renewal Kits → 4768RK → P306

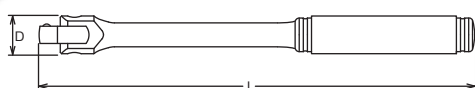

	D (mm)	L (mm)	(g)	(pcs.)
4768J-380	28	380	600	1
4768J-450	28	450	690	1
4768P-380	28	380	665	2
4768P-450	28	450	748	2

 4768-450 has longer handle than standard, and can be loaded to excessive torque value. Please use carefully.

	D (mm)	L (mm)	(g)	(pcs.)
4760-50	24	50	92	10
4760-75	24	75	138	10
4760-100	24	100	158	5
4760-125	24	125	194	5
4760-150	24	150	266	5
4760-200	24	200	295	5
4760-250	24	250	358	5
4760-300	24	300	492	2
4760-400	24	400	650	1
4760-500	24	500	808	1
4760-600	24	600	968	1
4760-900	24	900	1430	1
4760-1000	24	1000	1593	1

### 4760 Extension Bars Verlängerungen Rallonges

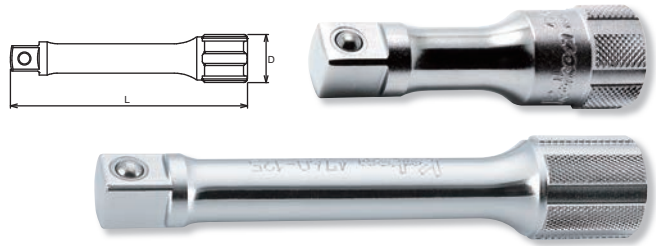

### PK4760/5 5 Pieces Set/△=1,050g PLASTIC TRAY

#### Extension Bars

4760 Extension Bars  
50, 75, 125, 150, 250

Rotation and general handling of extensions with oily hands is greatly improved with the **Kokon** developed 6 point knurling. Also the **Kokon** 6 point knurling stops the extensions from rolling around the work area.

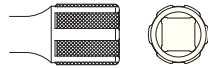

Durch die von **Kokon** entwickelte 6 fache Rändelung wird die Handhabung deutlich erleichtert. Außerdem wird das Herumrollen der Verlängerungen wirksam verhindert.

La manipulation des rallonges est grandement facilitée par le profil moleté développé par **Kokon**. Ce même profil empêche le roulement intempestif des rallonges sur le plan de travail.

### PK4760/5 Extension Bars in Plastic Box Verlängerungen in Kunststoff-Kassette Rallonges en boîte plastique



	D (mm)	L (mm)	(g)	(pcs.)
4763-50	24	50	95	10
4763-75	24	75	111	10
4763-125	24	125	157	5
4763-150	24	150	181	5
4763-250	24	250	357	5
4763-400	24	400	650	1

### 4763 Wobble-Fix Extension Bars Winkel-Verlängerungen Rallonges angulaires

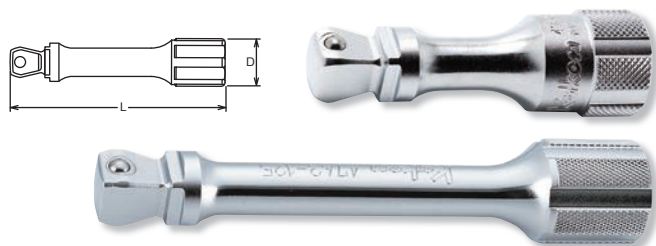

⚠ The Wobble-Fix Extension Bar has less strength than normal extension bar due to its specific design with a reduced square drive. Make sure to use it correctly.



### PK4763/5 5 Pieces Set/△=950g PLASTIC TRAY

#### Extension Bars

4763 Wobble-Fix Extension Bars  
50, 75, 125, 150, 250

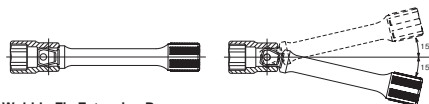

#### Wobble-Fix Extension Bar

Two way usage

- In a fixed position, as a normal extension bar
- In a half-fixed position, as a flexible extension bar providing a 15° angle operation

#### Winkel-Verlängerungen

Winkelverlängerungen lassen sich in zwei Einstellungen verwenden

- voll eingesteckt und starr,
- halb eingesteckt, mit einem Arbeitswinkel von 15°.

#### Rallonges angulaires

Deux utilisations possibles

- comme rallonge normale, dans une position fixe
- comme une rallonge angulaire avec une possibilité d'inclinaison jusqu'à 15°

### PK4763/5 Wobble-Fix Extension Bars in Plastic Box Winkel Verlängerungen in Kunststoff-Kassette Rallonges angulaires en boîte plastique



# Hand Sockets Hand Steckschlüssel Douilles à main

## 1/2"

Z-SERIES  
HAND  
TITANIUM  
SCREWDRIVERS ACCESSORIES  
IMPACT  
SLEEVE-DRIVE  
PROTECTOR  
INDUSTRIAL  
AUTOMOTIVE  
MOTORCYCLE  
CONSTRUCTION  
SPARE PART

**4770** Universal Joint  
Gelenk-Einsatz  
Cardan universel

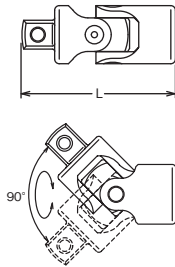

	L (mm)	(g)	(pcs.)
4770	62.4	150	10

**4771** Universal Joint  
Gelenk-Einsatz  
Joint articulé

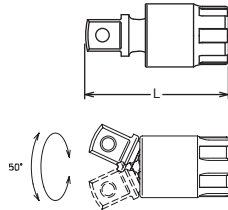

	L (mm)	(g)	(pcs.)
4771	57.7	113	10

**4780-400** Speed Handle  
Winde  
Vilebrequin

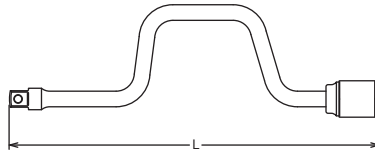

	L (mm)	(g)	(pce.)
4780	400	644	1

**4781N-450** Flexible Speed Handle  
Gelenkgriff-Winde  
Vilebrequin

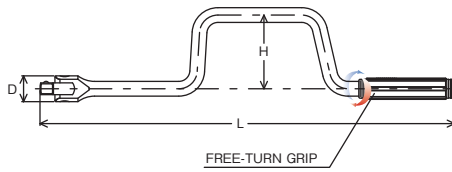

\* Renewal Kits → 4768RK → P306

	D (mm)	H (mm)	L (mm)	(g)	(pce.)
4781N-450	28	80	450	1000	1

**4785** T-Handle  
T-Griff  
Poignée coulissante



	L (mm)	(g)	(pcs.)
4785	300	410	2

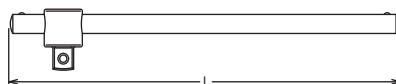



**4747** L-Handle  
L-Griff  
Poignées en L



	L <sub>1</sub> (mm)	L <sub>2</sub> (mm)	(g)	(pcs.)
<b>4747</b>	260	50	470	1

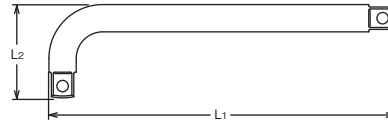

**4788-250 / -300 / -450** ⚠ L-Handles  
L-Griffe  
Poignées en L



	L <sub>1</sub> (mm)	L <sub>2</sub> (mm)	(g)	(pcs.)
<b>4788-250</b>	250	53	417	2
<b>4788-300</b>	300	53	503	1
<b>4788-450</b>	450	53	745	1



⚠ 4788-450 have longer handle than standard, and can be loaded to excessive torque value. In the interest of your own safety always apply load evenly and progressively to avoid breakage and possible injury.

	(sq.)	(sq.)	L (mm)	(g)	(pcs.)
<b>4433A-35</b>	1/2"	3/8"	35	50	10
<b>4433A-75</b>	1/2"	3/8"	75	120	10
<b>4433A-125</b>	1/2"	3/8"	125	164	5
<b>4433A-250</b>	1/2"	3/8"	250	275	5
<b>4433A-600</b>	1/2"	3/8"	600	530	1

Items in this catalogue marked ⚠ can be loaded to torque values which may cause breakage. In the interest of your own safety always apply load evenly and progressively to avoid breakage and possible injury.

Die mit ⚠ gekennzeichneten Artikel können bei Überbelastungen zu Bruch gehen. Aus Gründen Ihrer Sicherheit, sollten die betreffenden Werkzeuge nie ruckartig sondern nach und nach belastet werden, um Bruch und damit verbundene, mögliche Verletzungen zu vermeiden.

Il est possible d'appliquer aux articles marqués ⚠ des couples de serrage susceptibles d'occasionner leur rupture. Pour votre propre sécurité, veuillez toujours appliquer la charge d'une manière uniforme et progressive. Ceci pour éviter ruptures et accidents.

**4433A** Adaptors  
Verbindungsstücke  
Réducteurs Warranty 290Nm  
Garantie 290Nm Garantie 290Nm ⚠

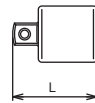

**4466A** Adaptor  
Verbindungsstück  
Réducteurs

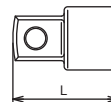

	(sq.)	(sq.)	L (mm)	(g)	(pcs.)
<b>4466A</b>	1/2"	3/4"	42	108	10

Hand Sockets  
Hand Steckschlüssel  
Douilles à main

# 1/2"

Z-SERIES  
HAND  
TITANIUM  
SCREWDRIVERS ACCESSORIES  
IMPACT  
SLEEVE-DRIVE  
PROTECTOR  
INDUSTRIAL  
AUTOMOTIVE  
MOTORCYCLE  
CONSTRUCTION  
SPARE PART

**4223M-01** Socket Sets  
Steckschlüssel Sätze  
Jeux de clés à douilles  
**4223M-06**



4223M-01 15 Pieces Set/△=2,600g  
4223M-06 15 Pieces Set/△=2,600g

METAL CASE:W415xH120xT50mm

Sockets	Accessories
(4223M-01) <b>4401M</b> 6-pt. Sockets 10, 11, 12, 13, 14, 15, 16, 17, 18, 19, 21, 22	<b>4753J</b> <b>4760-125</b> <b>4770</b>
(4223M-06) <b>4406M</b> 12-pt. Sockets 10, 11, 12, 13, 14, 15, 16, 17, 18, 19, 21, 22	

**4238AM** Socket Sets  
Steckschlüssel Sätze  
Jeux de clés à douilles



4238AM 38 Pieces Set/△=8,050g

METAL CASE:W446xH266xT50mm

Sockets	Accessories
<b>4405M</b> 12-pt. Sockets 10, 11, 12, 13, 14, 15, 16, 17, 18, 19, 21, 22, 23, 24, 26, 27, 30, 32	<b>4753N</b> <b>4760-125</b> <b>4760-250</b> <b>4770</b> <b>4780</b> <b>4785</b>
<b>4405A</b> 12-pt. Sockets 3/8, 7/16, 1/2, 9/16, 5/8, 11/16, 3/4, 13/16, 7/8, 15/16, 1.1/16, 1.1/8, 1.1/4	
<b>4300C</b> Spark Plug Socket 20.8	

**S4240M-01** Display Stands  
Ausstellungsstände  
Présentoirs  
**S4240A-00**   
**S4240M-06**   
**S4240A-05**



S4240M-01 4401M 117 Pieces Set/△=13,000g  
S4240M-06 4406M 117 Pieces Set/△=13,000g

DISPLAY STAND:W510xH150xT230mm

Sockets		
10mm:9pcs	16mm:9pcs	24mm:6pcs
11mm:9pcs	17mm:8pcs	27mm:5pcs
12mm:9pcs	19mm:7pcs	30mm:5pcs
13mm:9pcs	21mm:7pcs	32mm:4pcs
14mm:9pcs	22mm:6pcs	
15mm:9pcs	23mm:6pcs	

S4240A-00 4400A 103 Pieces Set/△=13,000g  
S4240A-05 4405A 103 Pieces Set/△=13,000g

DISPLAY STAND:W510xH150xT230mm

Sockets		
3/8" :9pcs	11/16":8pcs	1" :5pcs
7/16":9pcs	3/4" :7pcs	1.1/16":5pcs
1/2" :9pcs	13/16":7pcs	1.1/8" :5pcs
9/16":9pcs	7/8" :6pcs	1.3/16":5pcs
5/8" :9pcs	15/16":6pcs	1.1/4" :4pcs

**P4241M-01** Socket Sets  
Steckschlüssel Sätze  
Jeux de clés à douilles  
**P4241M-06**



P4241M-01 28 Pieces Set/△=6,400g

METAL CASE:W425xH332xT65mm

Sockets	Accessories
<b>4401M</b> 6-pt. Sockets 10, 11, 12, 13, 14, 15, 16, 17, 18, 19, 20, 21, 22, 23, 24, 25, 26, 27, 28, 29, 30, 32	<b>4753J</b> <b>4760-125</b> <b>4760-250</b> <b>4768J-380</b> <b>4770</b> <b>4785</b>





P4241M-06 28 Pieces Set/△=6,400g

METAL CASE:W425xH332xT65mm

Sockets	Accessories
<b>4406M</b> 12-pt. Sockets 10, 11, 12, 13, 14, 15, 16, 17, 18, 19, 20, 21, 22, 23, 24, 25, 26, 27, 28, 29, 30, 32	<b>4753J</b> <b>4760-125</b> <b>4760-250</b> <b>4768J-380</b> <b>4770</b> <b>4785</b>

4241M-01	28 Pieces Set/△=6,500g
4241M-06	28 Pieces Set/△=6,500g
4241M-10	28 Pieces Set/△=6,500g

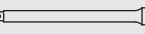
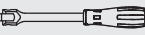
METAL CASE:W446xH266xT50mm

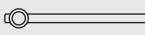





Sockets	Accessories
(4241M-01) <b>4401M</b> 6-pt. Sockets 10, 11, 12, 13, 14, 15, 16, 17, 18, 19, 20, 21, 22, 23, 24, 25, 26, 27, 28, 29, 30, 32	 <b>4753J</b>  <b>4760-125</b>  <b>4760-250</b>  <b>4768J-380</b>
(4241M-06) <b>4406M</b> 12-pt. Sockets 10, 11, 12, 13, 14, 15, 16, 17, 18, 19, 20, 21, 22, 23, 24, 25, 26, 27, 28, 29, 30, 32	 <b>4770</b>  <b>4785</b>
(4241M-10) <b>4410M</b> Surface Drive Sockets 10, 11, 12, 13, 14, 15, 16, 17, 18, 19, 20, 21, 22, 23, 24, 25, 26, 27, 28, 29, 30, 32	

**4241M-01** Socket Sets  
**4241M-06** Steckschlüssel Sätze  
**4241M-10** Jeux de clés à douilles

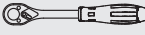

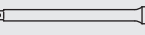
4241A-00	19 Pieces Set/△=4,900g
4241A-05	19 Pieces Set/△=4,900g

METAL CASE:W445xH190xT50mm





Sockets	Accessories
(4241A-00) <b>4400A</b> 6-pt. Sockets 3/8, 7/16, 1/2, 9/16, 5/8, 11/16, 3/4, 13/16, 7/8, 15/16, 1.1/16, 1.1/8, 1.1/4	 <b>4753J</b>  <b>4760-125</b>  <b>4760-250</b>  <b>4768J-380</b>
(4241A-05) <b>4405A</b> 12-pt. Sockets 3/8, 7/16, 1/2, 9/16, 5/8, 11/16, 3/4, 13/16, 7/8, 15/16, 1.1/16, 1.1/8, 1.1/4	 <b>4770</b>  <b>4785</b>

**4241A-00** Socket Sets  
**4241A-05** Steckschlüssel Sätze  
Jeux de clés à douilles

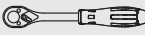

4249M-01	20 Pieces Set/△=4,800g
4249M-06	20 Pieces Set/△=4,800g

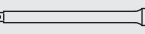
METAL CASE:W445xH190xT50mm

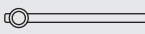



Sockets	Accessories
(4249M-01) <b>4401M</b> 6-pt. Sockets 10, 11, 12, 13, 14, 15, 16, 17, 18, 19, 21, 22, 24, 27, 30	 <b>4753J</b>  <b>4760-125</b>  <b>4760-250</b>
(4249M-06) <b>4406M</b> 12-pt. Sockets 10, 11, 12, 13, 14, 15, 16, 17, 18, 19, 21, 22, 24, 27, 30	 <b>4770</b>  <b>4785</b>

**4249M-01** Socket Sets  
**4249M-06** Steckschlüssel Sätze  
Jeux de clés à douilles

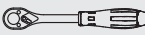

4250M-01	18 Pieces Set/△=4,700g
4250M-06	18 Pieces Set/△=4,700g
4250M-10	18 Pieces Set/△=4,700g

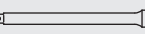
METAL CASE:W445xH190xT50mm

Sockets	Accessories
(4250M-01) <b>4401M</b> 6-pt. Sockets 10, 11, 12, 13, 14, 15, 17, 19, 22, 24, 27, 30, 32	 <b>4753J</b>  <b>4760-125</b>  <b>4760-250</b>
(4250M-06) <b>4406M</b> 12-pt. Sockets 10, 11, 12, 13, 14, 15, 17, 19, 22, 24, 27, 30, 32	 <b>4770</b>  <b>4785</b>
(4250M-10) <b>4410M</b> Surface Drive Sockets 10, 11, 12, 13, 14, 15, 17, 19, 22, 24, 27, 30, 32	

**4250M-01** Socket Sets  
**4250M-06** Steckschlüssel Sätze  
**4250M-10** Jeux de clés à douilles



Hand Sockets  
Hand Steckschlüssel 1/2"  
Douilles à main

Z-SERIES  
HAND  
TITANIUM  
SCREWDRIVERS ACCESSORIES  
IMPACT  
SLEEVE-DRIVE  
PROTECTOR  
INDUSTRIAL  
AUTOMOTIVE  
MOTORCYCLE  
CONSTRUCTION  
SPARE PART

**4251M-01** Socket Sets  
Steckschlüssel Sätze  
Jeux de clés à douilles  
**4251M-06**  
**4251M-10**  
**4251A-00**  
**4251A-05**



4251M-01	22 Pieces Set/⚖️=3,200g
4251M-06	22 Pieces Set/⚖️=3,200g
4251M-10	22 Pieces Set/⚖️=3,200g
4251A-00	18 Pieces Set/⚖️=2,700g
4251A-05	18 Pieces Set/⚖️=2,700g

METAL CASE:W330xH68xT48mm

Sockets	
(4251M-01) <b>4401M</b> 6-pt. Sockets	10, 11, 12, 13, 14, 15, 16, 17, 18, 19, 20, 21, 22, 23, 24, 25, 26, 27, 28, 29, 30, 32
(4251M-06) <b>4406M</b> 12-pt. Sockets	
(4251M-10) <b>4410M</b> Surface Drive Sockets	
(4251A-00) <b>4400A</b> 6-pt. Sockets	3/8, 7/16, 1/2, 9/16, 19/32, 5/8, 21/32, 11/16, 3/4, 25/32, 13/16, 7/8, 15/16, 1, 1.1/16, 1.1/8, 1.3/16, 1.1/4
(4251A-05) <b>4405A</b> 12-pt. Sockets	

**4252M-01** Socket Sets  
Steckschlüssel Sätze  
Jeux de clés à douilles  
**4252M-06**  
**4252M-10**



4252M-01	13 Pieces Set/⚖️=1,200g
4252M-06	13 Pieces Set/⚖️=1,200g
4252M-10	13 Pieces Set/⚖️=1,200g

METAL CASE:W168xH60xT42mm

Sockets	
(4252M-01) <b>4401M</b> 6-pt. Sockets	10, 11, 12, 13, 14, 15, 16, 17, 18, 19, 20, 21, 22
(4252M-06) <b>4406M</b> 12-pt. Sockets	
(4252M-10) <b>4410M</b> Surface Drive Sockets	

**4254** Socket Sets  
Steckschlüssel Sätze  
Jeux de clés à douilles



4254	12 Pieces Set/⚖️=1,070g
------	-------------------------

METAL CASE:W215xH80xT47mm

Sockets		Accessories	
3/8"	3425- E6, E8		4763-50
1/2"	4425- E10, E12, E14		4433A-35
3/8"	3325- E6, E8		
1/2"	4325- E10, E12, E14		

**4262M-01** Socket Sets  
Steckschlüssel Sätze  
Jeux de clés à douilles  
**4262M-06**  
**4262M-10**



4262M-01	20 Pieces Set/⚖️=4,400g
4262M-06	20 Pieces Set/⚖️=4,400g
4262M-10	20 Pieces Set/⚖️=4,400g





METAL CASE:W445xH190xT50mm

Sockets		Accessories	
(4262M-01) <b>4401M</b> 6-pt. Sockets	8, 10, 11, 12, 13, 14, 15, 16, 17, 18, 19, 21, 22, 24, 27		4753J
(4262M-06) <b>4406M</b> 12-pt. Sockets	8, 10, 11, 12, 13, 14, 15, 16, 17, 18, 19, 21, 22, 24, 27		4760-125
(4262M-10) <b>4410M</b> Surface Drive Sockets	8, 10, 11, 12, 13, 14, 15, 16, 17, 18, 19, 21, 22, 24, 27		4760-250
			4770
			4785



4272AM-01 29 Pieces Set/△=5,000g  
4272AM-06 29 Pieces Set/△=5,000g

METAL CASE:W445xH190xT50mm

Sockets	Accessories
(4272AM-01) <b>4401M</b> 6-pt. Sockets 10, 11, 12, 13, 14, 15, 16, 17, 18, 19, 21, 22, 24	 <b>4753J</b>
<b>4400A</b> 6-pt. Sockets 3/8, 7/16, 1/2, 9/16, 5/8, 11/16, 3/4, 13/16, 7/8, 15/16, 1	 <b>4760-125</b>
(4272AM-06) <b>4406M</b> 12-pt. Sockets 10, 11, 12, 13, 14, 15, 16, 17, 18, 19, 21, 22, 24	 <b>4760-250</b>
<b>4405A</b> 12-pt. Sockets 3/8, 7/16, 1/2, 9/16, 5/8, 11/16, 3/4, 13/16, 7/8, 15/16, 1	 <b>4770</b>
	 <b>4785</b>





## 4272AM-01 4272AM-06

Socket Sets  
Steckschlüssel Sätze  
Jeux de clés à douilles

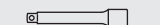
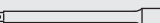

4275 24 Pieces Set/△=5,340g

METAL CASE:W445xH190xT50mm

Sockets	Accessories
<b>4406M</b> 12-pt. Sockets 10, 11, 12, 13, 14, 15, 16, 17, 18, 19, 21, 22, 24	 <b>4750J</b>
<b>4300C</b> Spark Plug Sockets 16, 20.8	 <b>4760-125</b>
<b>4300M</b> Wheel Nut Sockets 17(L60), 19(L60), 21(L60)	 <b>4760-250</b>
	 <b>4768J-380</b>
	 <b>4770</b>
	 <b>4785</b>

## 4275

Socket Sets  
Steckschlüssel Sätze  
Jeux de clés à douilles



4276 17 Pieces Set/△=2,890g

METAL CASE:W370xH150xT50mm

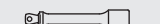
Sockets	Accessories
<b>4010M.50</b> Bit Sockets 6, 7, 8, 10, 12, 14	 <b>4752J</b>
<b>4025.60</b> TORX® Bit Sockets T20, T25, T27, T30, T40, T45, T50, T55, T60	 <b>4763-125</b>



## 4276

Socket Sets  
Steckschlüssel Sätze  
Jeux de clés à douilles

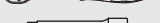

4277 27 Pieces Set/△=5,660g

METAL CASE:W445xH190xT50mm

Sockets	Accessories
<b>4406M</b> 12-pt. Sockets 10, 12, 13, 14, 15, 16, 17, 18, 19, 21, 22, 24	 <b>4750J</b>
<b>4305M</b> 12-pt. Deep Sockets 10, 12, 13, 14, 15, 16, 17, 18, 19, 21, 22, 24	 <b>4760-125</b>
	 <b>4768J-380</b>

## 4277

Socket Sets  
Steckschlüssel Sätze  
Jeux de clés à douilles



Z-SERIES  
HAND  
TITANIUM  
SCREWDRIVERS ACCESSORIES  
IMPACT  
SLEEVE-DRIVE  
PROTECTOR  
INDUSTRIAL  
AUTOMOTIVE  
MOTORCYCLE  
CONSTRUCTION  
SPARE PART

## 6400M / 6400A

6-point Sockets  
6-kant Steckschlüssel  
Douilles 6-pans

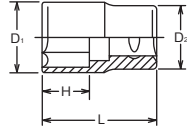

6400M 6405M (mm)	D <sub>1</sub> (mm)	D <sub>2</sub> (mm)	H (mm)	L (mm)	(g)	(pcs.)
14	22.1	34	11	50	160	10
16	24.6	34	12	50	167	10
17	26	34	12.5	50	175	5
18	27	34	13	50	178	5
19	28.5	34	13.5	50	179	5
20	29.5	34	14	50	185	5
21	31	34	14.5	50	185	5
22	32	34	15	50	187	5
23	33.5	34	16	50	187	5
24	34.5	34	17	50	200	5
25	36	34	17.5	50	217	5
26	37	34	18	50	222	5
27	38.5	37	19	53	254	5
28	39.5	38	19.5	53	298	5
29	41	38	20	55	292	5
30	42	38	21	55	301	5
31	43.5	38	22	57	294	5
32	44.5	40	23	57	351	5
33	46	40	23.5	57	384	5
34	47	40	24	57	397	5
35	48.5	42	24.5	59	422	5
36	49.5	42	25	59	438	5
37	51	42	25.5	59	484	5
38	52	45	26	59	523	5
39	53.5	45	26.5	59	538	5
40	54.5	45	27	62	550	5
41	56	47	28	62	633	5
42	57	47	28.5	62	652	2
43	58.5	47	29	62	659	2
44	59.5	47	29.5	62	657	2
45	61	47	30	68	734	2
46	62	47	31	68	791	2
47	63.5	48	31.5	68	816	2
48	64.5	45	32	68	800	2
50	67	48	34	68	880	2
52	69.5	53	33	72	925	2
54	72	55	33	72	1040	2
55	73.5	53	36	72	1006	2
56	74.5	53	36	72	1092	2
57	76	53	36	72	1169	2
58	77	53	36	72	1149	2
60	79.5	58	39	76	1402	2
63	83.5	58	39	76	1494	2
65	86	63	42	80	1608	2
70	92	68	45	84	1785	2
75	98.5	73	48	86	2186	1
78	102.1	73	55	86	2425	1
80	104.5	78	52	90	2475	1
85	111	78	52	90	2620	1

## 6405M / 6405A

12-point Sockets  
12-kant Steckschlüssel  
Douilles 12-pans

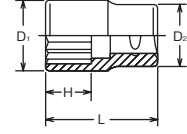

6400A 6405A (inch)	D <sub>1</sub> (mm)	D <sub>2</sub> (mm)	H (mm)	L (mm)	(g)	(pcs.)
5/8	24.6	34	12	50	168	10
11/16	27	34	13	50	178	5
3/4	28.5	34	13.5	50	179	5
25/32	29.5	34	14	50	185	5
13/16	31	34	14.5	50	185	5
7/8	32	34	15	50	187	5
15/16	34.5	34	17	50	200	5
31/32	36	34	17.5	50	217	5
1	37	34	18	50	222	5
1. 1/16	38.5	37	19	53	254	5
1. 1/8	41	38	20	53	292	5
1. 3/16	42	38	21	55	301	5
1. 1/4	44.5	40	23	57	351	5
1. 5/16	46	40	23.5	57	384	5
1. 3/8	48.5	42	24.5	57	422	5
1. 7/16	51	42	25.5	59	484	5
1. 1/2	52	45	26	59	523	5
1. 9/16	54.5	45	27	59	550	5
1. 5/8	56	47	28	62	633	5
1.11/16	58.5	47	29	62	659	2
1. 3/4	59.5	47	29.5	62	657	2
1.13/16	62	47	31	68	791	2
1. 7/8	64.5	45	32	68	892	2
1.15/16	66	48	32.5	68	870	2
2	68.5	52	34.5	68	949	2
2. 1/16	71	54	33	72	983	2
2. 1/8	72	55	33	72	1040	2
2. 3/16	74.5	53	36	72	1092	2
2. 1/4	76	53	36	72	1169	2
2. 5/16	78.5	53	36	72	1344	2
2. 3/8	79.5	58	39	76	1402	2
2. 7/16	82	58	39	76	1420	2
2. 1/2	84.5	58	39	76	1497	2
2. 9/16	86	63	42	80	1608	2
2. 5/8	88.5	63	42	80	1709	2
2.11/16	89.5	63	42	80	1634	2
2. 3/4	92	68	45	84	1785	2
2.13/16	94.5	68	45	84	2018	2
2. 7/8	96	68	45	84	2062	2
2.15/16	98.5	73	48	86	2186	1
3	101	73	48	86	2309	1
3. 1/8	104.5	78	52	90	2475	1

## 6425

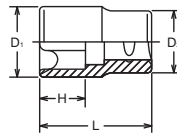

TORX® Sockets  
TORX® Steckschlüssel  
Douilles TORX®



6425 (E)	D <sub>1</sub> (mm)	D <sub>2</sub> (mm)	H (mm)	L (mm)	(g)	(pcs.)
E18	22.1	34	11.9	50	156	5
E20	24.6	34	13.3	50	166	5
E22	27.1	34	14.4	50	178	5
E24	28.6	34	16	50	185	5
E26	31.1	34	17.7	55	217	5
E28	32.1	34	24.1	60	237	5
E30	35	34	24.1	60	242	5
E32	36.1	34	24.1	60	247	5

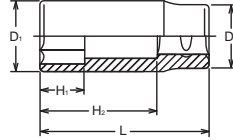

## 6300M / 6300A 6-point Deep Sockets 6-kant-Steckschlüssel,lang Douilles longues 6-pans





6300M 6305M (mm)	D <sub>1</sub> (mm)	D <sub>2</sub> (mm)	H <sub>1</sub> (mm)	H <sub>2</sub> (mm)	L (mm)	 (g)	 (pcs.)
17	26	34	18	64	90	278	5
18	27	34	19	64	90	281	5
19	28.5	34	20	64	90	292	5
20	29.5	34	21	64	90	334	5
21	31	34	22	64	90	343	5
22	32	34	23	64	90	347	5
23	33.5	34	24	64	90	361	5
24	34.5	34	25	64	90	352	5
25	36	34	26	64	90	369	5
26	37	34	27	64	90	384	5
27	38.5	37	28	64	90	425	5
28	39.5	38	29	63	90	470	5
29	41	38	30	63	90	503	5
30	42	38	31	63	90	503	5
31	43.5	38	32	62	90	517	5
32	44.5	40	34	62	90	544	5
33	46	40	34	62	90	557	5
34	47	40	35	61	90	570	5
35	48.5	42	36	61	90	622	5
36	49.5	42	37	61	90	631	2
38	52	45	39	60	90	710	2
40	54.5	45	41	60	90	742	2
41	56	47	42	59	90	802	2
42	57	47	43	59	90	829	2
44	59.5	47	45	59	90	838	2
46	62	47	47	58	90	906	2
48	64.5	50	49	57	90	998	2
50	67	48	51	57	90	1005	2
52	69.5	53	49	-	100	1270	2
53	71	54	49	-	100	1338	2
54	72	55	49	-	100	1351	2
55	73.5	53	52	-	100	1388	2
56	74.5	53	52	-	100	1389	2
57	76	53	52	-	100	1467	2
58	77	53	52	-	100	1480	2
60	79.5	58	55	-	100	1626	2
63	83.5	58	55	-	100	1740	2
65	86	63	65	-	100	1939	2

## 6305M / 6305A 12-point Deep Sockets 12-kant Steckschlüssel,lang Douilles longues, 12-pans



6300A 6305A (inch)	D <sub>1</sub> (mm)	D <sub>2</sub> (mm)	H <sub>1</sub> (mm)	H <sub>2</sub> (mm)	L (mm)	 (g)	 (pcs.)
3/4	28.5	34	20	64	90	292	5
25/32	29.5	34	21	64	90	334	5
13/16	31	34	22	64	90	343	5
7/8	32	34	23	64	90	347	5
15/16	34.5	34	25	64	90	352	5
1	37	34	27	64	90	384	5
1. 1/16	38.5	37	28	64	90	425	5
1. 1/8	41	38	30	63	90	503	5
1. 3/16	42	38	31	63	90	503	5
1. 1/4	44.5	40	34	62	90	544	5
1. 5/16	46	40	34	62	90	557	5
1. 3/8	48.5	42	36	61	90	622	5
1. 7/16	51	42	38	61	90	656	2
1. 1/2	52	45	39	60	90	710	2
1. 9/16	54.5	45	41	60	90	742	2
1. 5/8	56	47	42	59	90	802	2
1.11/16	58.5	47	44	59	90	831	2
1. 3/4	59.5	47	45	59	90	838	2
1.13/16	62	47	47	58	90	906	2
2	68.5	52	52	57	90	1061	2
2. 1/16	71	54	49	-	100	1338	2
2. 1/8	72	55	49	-	100	1351	2
2. 3/16	74.5	53	52	-	100	1389	2
2. 1/4	76	53	52	-	100	1467	2
2. 5/16	78.5	53	52	-	100	1787	2
2. 3/8	79.5	58	55	-	100	1626	2
2. 7/16	82	58	55	-	100	1715	2

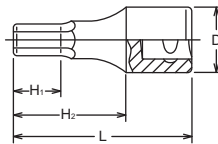

6012M-75 (mm)	D (mm)	H <sub>1</sub> (mm)	H <sub>2</sub> (mm)	L (mm)	 (g)	 (pcs.)
12	35	15.5	40	75	253	10
14	35	15.5	40	75	265	10
15	35	15.5	40	75	271	10
16	35	15.5	40	75	285	10
17	35	15.5	40	75	292	10
18	35	15.5	40	75	302	10
19	35	15.5	40	75	312	10
20	35	15.5	40	75	323	10
21	38	15.5	40	75	330	10
22	38	22.5	40	75	340	10
24	38	22.5	40	75	362	10
27	38	22.5	40	75	402	10
30	38	28.5	40	75	445	10
32	38	28.5	40	75	485	10
36	42	28.5	40	75	663	10

## 6012M-75 Inhex Sockets Steckschlüssel für Innensechskant-Schrauben Douilles tournevis pour vis 6-pans creux

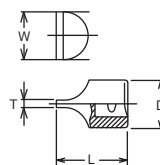

## 6101 Socket for Slotted Heads Steckschlüssel für Schlitzschrauben Douilles tournevis pour vis à fente



	TxW (mm)	D (mm)	L (mm)	 (g)	 (pcs.)
6101	6.4x33.5	35	50	205	5

Z-SERIES  
HAND  
TITANIUM  
ACCESSORIES  
SCREWDRIVERS  
IMPACT  
SLEEVE-DRIVE  
PROTECTOR  
INDUSTRIAL  
AUTOMOTIVE  
MOTORCYCLE  
CONSTRUCTION  
SPARE PART

**6749**  
**6749-1000** ⚠️  
**6749-HEAD**  
**PIPE-400 / -800**

Reversible Ratchet  
Knarre, verstellbar  
Cliquet, réversible





\* Renewal Kits → 6749RK → P304

RATCHET HANDLE

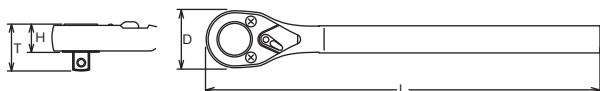

	D (mm)	T (mm)	H (mm)	L (mm)	(g)	(pce.)
6749	68	49.6	29.6	565	2840	1
6749-1000	68	49.6	29.6	965	3960	1
6749-HEAD	68	49.6	29.6	165	1730	1
PIPE-400	-	-	-	400	1110	1
PIPE-800	-	-	-	800	2230	1

⚠️ 6749-1000 have longer handle than standard, and can be loaded to excessive torque value. In the interest of your own safety always apply load evenly and progressively to avoid breakage and possible injury.



**6752**  
**6752-HEAD**  
**PIPE-400**

Reversible Ratchet  
Knarre, verstellbar  
Cliquet, réversible



\* Renewal Kits → 6752RK → P305

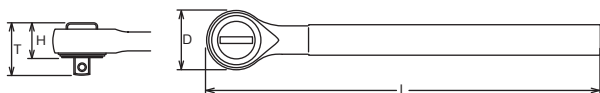

	D (mm)	T (mm)	H (mm)	L (mm)	(g)	(pce.)
6752	67	55.5	35.5	500	2360	1
6752-HEAD	67	55.5	35.5	100	1250	1
PIPE-400	-	-	-	400	1110	1



# 3/4"

Hand Sockets  
Hand Steckschlüssel  
Douilles à main

Z-SERIES  
HAND  
TITANIUM  
ACCESSORIES  
SCREWDRIVERS  
IMPACT  
SLEEVE-DRIVE  
PROTECTOR  
INDUSTRIAL  
AUTOMOTIVE  
MOTORCYCLE  
CONSTRUCTION  
SPARE PART

60

\* Renewal Kits → 6755RK → P306

	D (mm)	L (mm)	(g)	(pce.)
6755	62	97	1162	1

**6755** Ratchet Adaptor  
Aufsteckknarre  
Cliquet adaptable

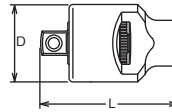

**6760** Extension Bars  
Verlängerungen  
Rallonges



	D (mm)	L (mm)	(g)	(pcs.)
6760-75	35	75	335	10
6760-100	35	100	434	10
6760-125	35	125	528	10
6760-150	35	150	624	2
6760-200	35	200	815	1
6760-300	35	300	1203	1
6760-400	35	400	1585	1



**6768** Hinge Handle  
Gelenkgriff  
Poignée articulée



\* Renewal Kits → 6768RK → P306

	D (mm)	L (mm)	(g)	(pce.)
6768	42	450	1715	1

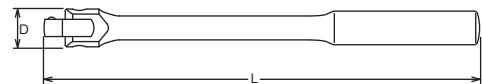

**6768-600 / -1000** ⚠ Hinge Handle  
Gelenkgriff  
Poignée articulée  
**6768-HEAD**  
**PIPE-400 / -800**



\* Renewal Kits → 6768RK → P306

	D (mm)	L (mm)	(g)	(pce.)
6768				
6768-600	42	600	2360	1
6768-1000	42	1000	3480	1
6768-HEAD	42	200	1250	1
PIPE-400	-	400	1110	1
PIPE-800	-	800	2230	1

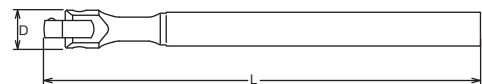

⚠ 6768-600/-1000 have longer handle than standard, and can be loaded to excessive torque value. In the interest of your own safety always apply load evenly and progressively to avoid breakage and possible injury.



Z-SERIES  
HAND  
TITANIUM  
SCREWDRIVERS ACCESSORIES  
IMPACT  
SLEEVE-DRIVE  
PROTECTOR  
INDUSTRIAL  
AUTOMOTIVE  
MOTORCYCLE  
CONSTRUCTION  
SPARE PART

**6785** T-Handle  
T-Griff  
Poignée coulissante

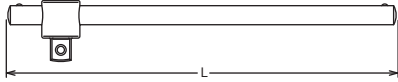

	L (mm)	(g)	(pce.)
<b>6785</b>	500	1542	1

**6788** L-Handle  
L-Griff  
Poignée en L



	L (mm)	(g)	(pce.)
<b>6788</b>	330	1175	1

**6770** Universal Joint  
Gelenk-Einsatz  
Cardan universel

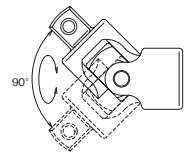
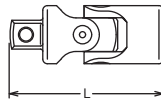

	L (mm)	(g)	(pcs.)
<b>6770</b>	105	478	2

**6644A** Adaptor  
Verbindungsstück  
Réducteur  
Warranty 668Nm  
Garantie 668Nm  
Garantie 668Nm

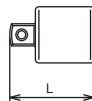

	(sq.)	(sq.)	L (mm)	(g)	(pcs.)
<b>6644A</b>	3/4"	1/2"	47	136	5
<b>6688A</b>	3/4"	1"	60	285	5

Adapting down from bigger square drive to smaller square drive may lead to excessive torque load and possibly cause breakage. Always stay within safe torque of the smaller square drive.

Die mit gekennzeichneten Artikel können bei Überbelastung zu Bruch gehen. Aus Gründen Ihrer eigenen Sicherheit sollten die betreffenden Werkzeuge nie ruckartig, sondern nach und nach belastet werden, um Bruch und damit verbundene mögliche Verletzungen zu vermeiden.

Il est possible d'appliquer aux articles marqués des couples de serrage susceptibles d'occasionner leur rupture. Pour votre propre sécurité, veuillez toujours appliquer la charge d'une manière uniforme et progressive. Ceci pour éviter ruptures et accidents.

**6688A** Adaptor  
Verbindungsstück  
Augmentateur

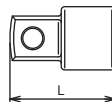

# 3/4"

Hand Sockets  
Hand Steckschlüssel  
Douilles à main

**6201M-00**  
**6201A-00**  
**6201M-05**  
**6201A-05**

Socket Sets  
Steckschlüssel Sätze  
Jeux de clés à douilles



6201A-00	18 Pieces Set/△=17,600g
6201A-05	18 Pieces Set/△=17,600g
METAL CASE:W580xH200xT85mm	
Sockets	Accessories
(6201A-00) <b>6400A</b> 6-pt. Sockets 7/8, 15/16, 1.1/16, 1.1/8, 1.1/4, 1.5/16, 1.7/16, 1.1/2, 1.5/8, 1.11/16, 1.13/16, 1.7/8, 2	<b>6749</b> <b>6760-200</b> <b>6760-400</b> <b>6768</b> <b>6785</b>
(6201A-05) <b>6405A</b> 12-pt. Sockets 7/8, 15/16, 1.1/16, 1.1/8, 1.1/4, 1.5/16, 1.7/16, 1.1/2, 1.5/8, 1.11/16, 1.13/16, 1.7/8, 2	

6201M-00	16 Pieces Set/△=17,300g
6201M-05	16 Pieces Set/△=17,300g
METAL CASE:W580xH200xT85mm	
Sockets	Accessories
(6201M-00) <b>6400M</b> 6-pt. Sockets 22, 24, 27, 30, 32, 36, 41, 46, 50, 55, 60	<b>6749</b> <b>6760-200</b> <b>6760-400</b> <b>6768</b> <b>6785</b>
(6201M-05) <b>6405M</b> 12-pt. Sockets 22, 24, 27, 30, 32, 36, 41, 46, 50, 55, 60	

**6212M-00**  
**6212M-05**

Socket Sets  
Steckschlüssel Sätze  
Jeux de clés à douilles



6212M-00	12 Pieces Set/△=8,200g
6212M-05	12 Pieces Set/△=8,200g
METAL CASE:W580xH124xT70mm	
Sockets	Accessories
(6212M-00) <b>6400M</b> 6-pt. Sockets 22, 24, 27, 30, 32, 36, 41, 46, 50	<b>6749</b> <b>6760-200</b> <b>6785</b>
(6212M-05) <b>6405M</b> 12-pt. Sockets 22, 24, 27, 30, 32, 36, 41, 46, 50	

Z-SERIES  
HAND  
TITANIUM  
ACCESSORIES  
SCREWDRIVERS  
IMPACT  
SLEEVE-DRIVE  
PROTECTOR  
INDUSTRIAL  
AUTOMOTIVE  
MOTORCYCLE  
CONSTRUCTION  
SPARE PART

Hand Sockets  
Hand Steckschlüssel  
Douilles à main



SPARE PART CONSTRUCTION MOTORCYCLE AUTOMOTIVE INDUSTRIAL PROTECTOR SLEEVE-DRIVE IMPACT SOREWDRIVERS ACCESSORIES TITANIUM HAND Z-SERIES

**8400M / 8400A**

6-point Sockets  
6-kant Steckschlüssel  
Douilles 6-pans

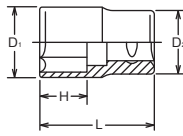

**8405M / 8405A**

12-point Sockets  
12-kant Steckschlüssel  
Douilles 12-pans

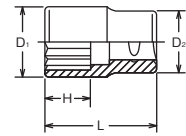

8400M 8405M (mm)	D <sub>1</sub> (mm)	D <sub>2</sub> (mm)	H (mm)	L (mm)	(g)	(pce.)
24	36.5	44	17	60	348	1
27	40.5	44	19	60	362	1
28	41.5	44	19.5	60	368	1
29	43	44	20	60	378	1
30	44	45	21	65	410	1
32	46.5	45	23	65	455	1
33	48	46	23.5	65	485	1
34	49	46	24	65	500	1
35	50.5	48	24.5	65	536	1
36	51.5	48	25	65	600	1
38	54	50	26	65	624	1
40	56.5	53	27	65	686	1
41	58	53	28	68	747	1
42	59	53	28.5	68	789	1
46	64	53	31	72	928	1
50	69	53	34	72	943	1
54	74	55	37	72	1016	1
55	75.5	53	42	77	1167	1
56	76.5	53	42	77	1160	1
58	79	53	41	77	1200	1
60	81.5	58	46	82	1440	1
63	85.5	58	45	82	1470	1
64	86.5	58	46	82	1540	1
65	88	63	49	86	1683	1
67	90.5	63	49	86	1840	1
68	91.5	63	49	86	1800	1
70	94	68	50	88	1963	1
71	95.5	68	50	88	2200	1
75	100.5	73	53	90	2204	1
78	104	75	52.5	90	2500	1
80	106.5	75	58	95	2550	1
83	110.5	78	57	95	2730	1
85	113	80	57	95	2680	1
90	119	80	59	100	3420	1
95	125.5	85	58	100	4900	1
100	131.5	85	57	100	4840	1

8400A 8405A (inch)	D <sub>1</sub> (mm)	D <sub>2</sub> (mm)	H (mm)	L (mm)	(g)	(pce.)
15/16	36.5	44	17	60	355	1
1. 3/16	44	45	21	65	410	1
1. 1/4	46.5	45	23	65	455	1
1. 5/16	48	46	23.5	65	485	1
1. 3/8	50.5	48	24.5	65	536	1
1. 7/16	53	50	25.5	65	607	1
1. 1/2	54	50	26	65	624	1
1. 9/16	56.5	53	27	65	686	1
1. 5/8	58	53	28	68	747	1
1.11/16	60.5	53	29	68	830	1
1. 3/4	61.5	53	29.5	68	807	1
1.13/16	64	53	31	72	928	1
1. 7/8	66.5	53	32	72	936	1
1.15/16	68	53	32.5	72	941	1
2	70.5	53	37	72	976	1
2. 1/16	73	54	37	72	1027	1
2. 1/8	74	55	37	72	1016	1
2. 3/16	76.5	53	41	77	1192	1
2. 1/4	78	53	41	77	1177	1
2. 5/16	80.5	53	41	77	1292	1
2. 3/8	81.5	58	46	82	1440	1
2. 7/16	84	58	45	82	1495	1
2. 1/2	86.5	58	45	82	1497	1
2. 9/16	88	63	49	86	1683	1
2. 5/8	90.5	63	49	86	1840	1
2.11/16	91.5	63	49	86	1800	1
2. 3/4	94	68	50	88	1963	1
2.13/16	96.5	68	50	88	2035	1
2. 7/8	98	70	50	88	2100	1
2.15/16	100.5	73	53	90	2204	1
3	103	75	53	90	2406	1
3. 1/8	106.5	75	58	95	2550	1
3. 1/4	110.5	78	57	95	2730	1
3. 3/8	114	80	57	95	3050	1
3. 1/2	119	80	59	100	3420	1
3. 3/4	125.5	85	58	100	4900	1



8012M-80 (mm)	D (mm)	H <sub>1</sub> (mm)	H <sub>2</sub> (mm)	L (mm)	(g)	(pcs.)
17	44.2	15.5	45	80	400	5
19	44.2	15.5	45	80	410	5
22	47.9	22.5	45	80	436	5
24	47.9	22.5	45	80	471	5
27	47.9	22.5	45	80	526	5
30	47.9	22.5	45	80	658	5
32	47.9	22.5	45	80	715	5
36	54.2	22.5	45	80	945	5

## 8012M-80

 Inhex Sockets  
Steckschlüssel für Innensechskant-Schrauben  
Douilles tournevis pour vis 6-pans creux

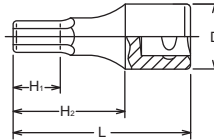

	D (mm)	L (mm)	(g)	(pce.)
8760-200	44	200	1300	1
8760-400	44	400	2570	1

## 8760

Extension Bars  
Verlängerungen  
Rallonges

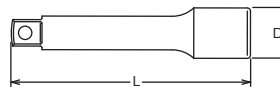

	L (mm)	(g)	(pce.)
8770	143	1170	1

## 8770

Universal Joint  
Gelenk-Einsatz  
Cardan universel

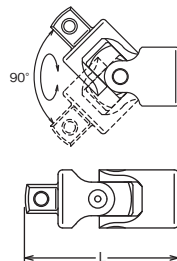

	(mm)	(mm)	L (mm)	(g)	(pcs.)
8866A	1"	3/4"	60	338	5

 Adapting down from bigger square drive to smaller square drive may lead to excessive torque and possibly cause breakage.

Reduzierstücke sind mit Vernunft einzusetzen.  
Es besteht Bruchgefahr. Überschreiten Sie niemals die Sicherheitsgrenzen.

Les réducteurs doivent être utilisés avec modération. Ne dépassez jamais les limites de sécurité.

## 8866A

Adaptor  
Verbindungsstück  
Réducteur

Warranty 1850Nm   
Garantie 1850Nm  
Garantie 1850Nm

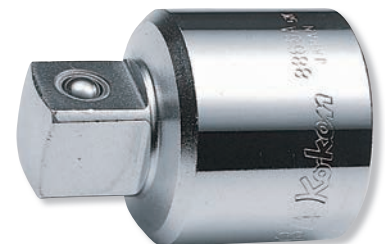
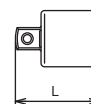

**8749**  
**8749-1000** ⚠  
**8749-HEAD**  
**PIPE-580 / -800**

Reversible Ratchet  
Knarre, verstellbar  
Cliquet, réversible



\* Renewal Kits → 8749RK → P304

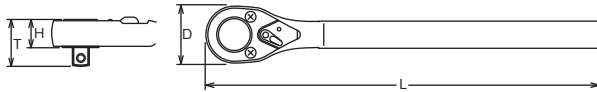

	D (mm)	T (mm)	H (mm)	L (mm)	(g)	(pce.)
8749	70	62.2	36.2	800	4100	1
8749-1000	70	62.2	36.2	1020	4720	1
8749-HEAD	70	62.2	36.2	220	2490	1
PIPE-580	—	—	—	580	1610	1
PIPE-800	—	—	—	800	2230	1

⚠ 8749-1000 have longer handle than standard, and can be loaded to excessive torque value. In the interest of your own safety always apply load evenly and progressively to avoid breakage and possible injury.

**8768**  
**8768-1000** ⚠  
**8768-HEAD**  
**PIPE-400 / -800**

Hinge Handle  
Gelenkgriff  
Poignée articulée

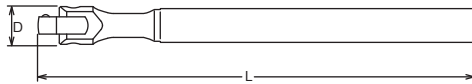

\* Renewal Kits → 8768RK → P306

	D (mm)	L (mm)	(g)	(pce.)
8768	55	600	2590	1
8768-1000	55	1000	3710	1
8768-HEAD	55	200	1480	1
PIPE-400	—	400	1110	1
PIPE-800	—	800	2230	1

⚠ 8768-1000 have longer handle than standard, and can be loaded to excessive torque value. In the interest of your own safety always apply load evenly and progressively to avoid breakage and possible injury.

**8785**  
**8785-700** ⚠

T-Handle  
T-Griff  
Poignée coulissante

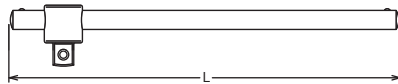
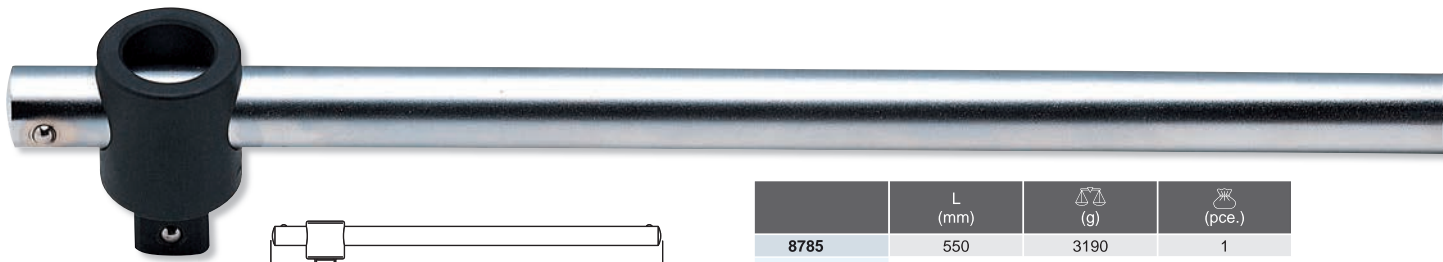

	L (mm)	(g)	(pce.)
8785	550	3190	1
8785-700	700	3906	1

⚠ 8785-700 have longer handle than standard, and can be loaded to excessive torque value. In the interest of your own safety always apply load evenly and progressively to avoid breakage and possible injury.

**8788**  
L-Handle  
L-Griff  
Poignée en L

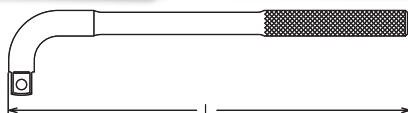
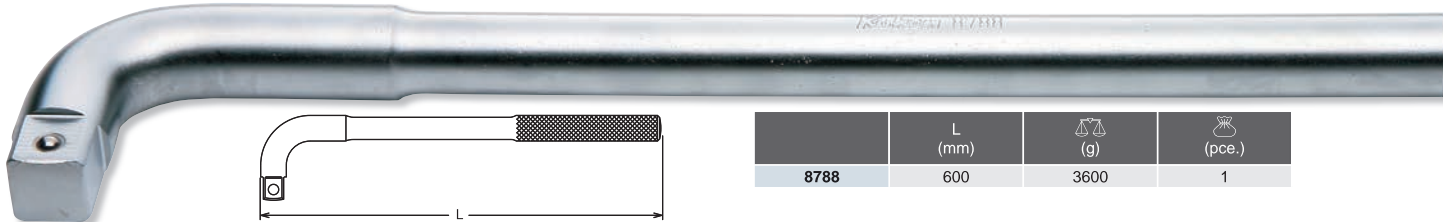

	L (mm)	(g)	(pce.)
8788	600	3600	1

# 1”

Hand Sockets  
Hand Steckschlüssel  
Douilles à main

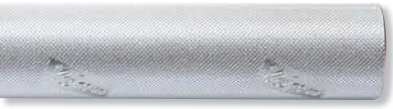
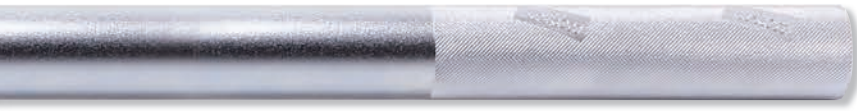

Z-SERIES  
HAND  
TITANIUM  
ACCESSORIES  
SCREWDRIVERS  
IMPACT  
SLEEVE-DRIVE  
PROTECTOR  
INDUSTRIAL  
AUTOMOTIVE  
MOTORCYCLE  
CONSTRUCTION  
SPARE PART

Hand Sockets  
Hand Steckschlüssel 1"  
Douilles à main

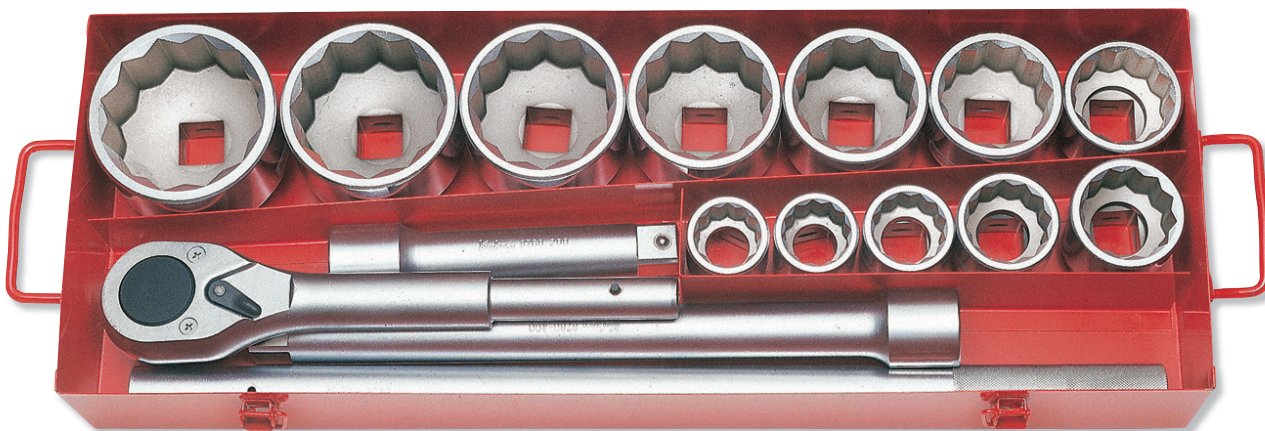

**8225M-00** Socket Sets  
Steckschlüssel Sätze  
Jeux de clés à douilles

**8225M-05**



8225M-00 15 Pieces Set/重量=27,000g  
8225M-05 15 Pieces Set/重量=27,000g

METAL CASE:W600xH217xT97mm

Sockets	Accessories
(8225M-00) <b>8400M</b> 6-pt. Sockets 32, 33, 36, 41, 46, 50, 55, 60, 65, 70, 75, 80	 <b>8749</b>
(8225M-05) <b>8405M</b> 12-pt. Sockets 32, 33, 36, 41, 46, 50, 55, 60, 65, 70, 75, 80	 <b>8760-200</b>
	 <b>8760-400</b>



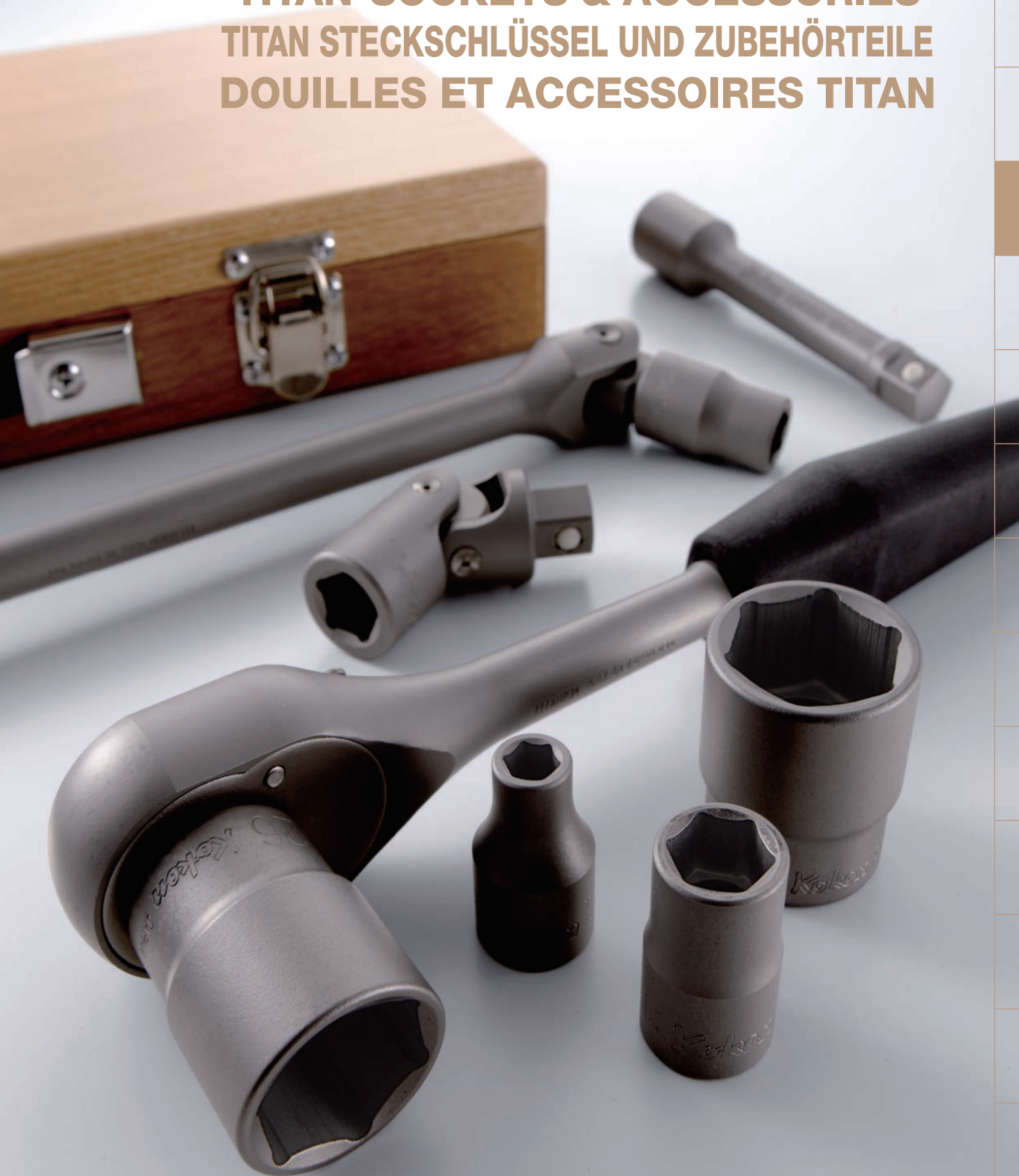

**TITAN-SOCKETS & ACCESSORIES**  
**TITAN STECKSCHLÜSSEL UND ZUBEHÖRTEILE**  
**DOUILLES ET ACCESSOIRES TITAN**



## TI4261M

Socket Set Titanium  
Steckschlüssel Satz Titanium  
Jeu de clés à douille Titanium

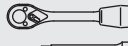
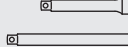
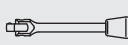
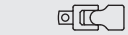

TI4261M		18 Pieces Set/△=4,280g	
WOODEN CASE:W445xH190xT60mm			
Sockets		Accessories	
	<b>TI4400M</b> 6-pt. Sockets 8, 10, 11, 12, 13, 14, 17, 19, 21, 22, 24, 26, 27		<b>TI4749J</b>
			<b>TI4760-125</b>
			<b>TI4760-250</b>
			<b>TI4768J-380</b>
			<b>TI4770</b>

### Characteristic of TITAN

- Light weight** : Makes it effective for operating tools. The specific gravity is only about 58% of chrome molybdenum steel which is used for our normal products.
- Non-Corrosion** : Corrosion Resistance is greatly improved against salt water and any kind of chemical products.
- Non-Magnetic** : Non-Magnetic material will prevent the tools from magnetizing.

### Eigenschaften der TITAN Legierung

- Geringes Gewicht** : Das spezifische Gewicht liegt bei 58% herkömmlicher Chrom-Molybdän Stähle.
- Korrosionsfest** : Meerwasser oder Säuren hinterlassen keine Spuren.
- Nicht magnetisch** : Titan Werkzeuge lassen sich nicht magnetisieren.

### Caractéristiques de l'alliage TITAN

- Légèreté** : Son poids spécifique n'est que 58% de celui de l'acier au chrome-molybdène utilisé pour tous nos produits standards.
- Anti-corrosion** : Aussi bien pour l'eau que pour tous les produits chimiques.
- Anti-magnétique** : Le Titan empêche toute magnétisation de l'outil.



Pentagonal drive is designed to avoid using with normal square drive items, so that it will provide extra safety and much more strength.

Der 5-kant Antrieb (Pentagon-Drive) gewährt einen kraftvollen Anzug und unterbindet aus Sicherheitsgründen die Verwendung von Zubehörteilen anderer Legierungen.

L'entraînement pentagonal est conçu pour obtenir un serrage puissant et pour empêcher l'utilisation d'accessoires traditionnels et ce pour des raisons de sécurité.



**ACCESSORIES**  
**ZUBEHÖRTEILE**  
**ACCESSOIRES**



Stud Pullers & Setters  
 Stehbolzendreher  
 Extracteurs de goujons

Z-SERIES  
 HAND  
 TITANIUM  
 ACCESSORIES  
 SCREWDRIVERS  
 IMPACT  
 SLEEVE-DRIVE  
 PROTECTOR  
 INDUSTRIAL  
 AUTOMOTIVE  
 MOTORCYCLE  
 CONSTRUCTION  
 SPARE PART

**4100M / 4100A** ○ Screw and Stud Pullers  
 Stehbolzendreher  
 Extracteurs de goujons

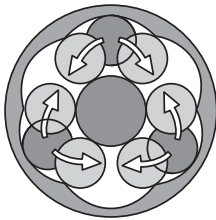
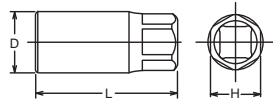

**Screw and Stud Pullers**  
 Hexagon body design can lessen the excessive load on cages and rollers inside the pullers.

**Stehbolzendreher**  
 Der neue Körper mit sechs Walzenmulden verteilt den Druck auf Käfig und Walzen weitaus vorteilhafter.

**Extracteurs de goujons**  
 Le nouveau corps de forme hexagonale répartit l'effort de façon plus uniforme sur la cage et les rouleaux.

4100M (mm)	□	D (mm)	L (mm)	H (mm)	(g)	(pcs.)	
5	1/2"	24	65	21	145	10	
6		24	65	21	150	10	
7		24	65	21	150	10	
8		24	65	21	147	10	
9		28	75	21	217	10	
10		28	75	21	213	10	
10.5		28	75	21	202	10	
11		28	75	21	218	10	
12		28	75	21	220	10	
14		34	75	27	340	5	
16		-⚠	34	75	27	315	5

4100A (inch)	□	D (mm)	L (mm)	H (mm)	(g)	(pcs.)
1/4	1/2"	24	65	21	150	10
5/16		24	65	21	147	10
3/8		28	75	21	213	10
7/16		28	75	21	218	10
1/2		28	75	21	191	10
9/16		34	75	27	340	5
5/8	-⚠	34	75	27	315	5

\* Renewal Kits → **4100MRK/4100ARK** → P307  
 ⚠ 4100M-16 and 4100A-5/8 do not have 1/2" square drive.  
 Drive the outer hexagon part with 27mm sockets or ring wrenches.  
 Die Artikel 4100M 16mm und 4100A 5/8" haben keinen 1/2" Antriebsvierkant.  
 Bitte benutzen Sie den 27mm Aussensechskant.  
 Les articles 4100M-16 et 4100A-5/8" n'ont pas de carré entraînant 1/2" , veuillez utiliser l'hexagonal 6 pans 27 mm

Tolerance			
4100M (mm)		4100A (inch)	
5	4.7- 5	1/4	6 - 6.4
6	5.6- 6	5/16	7.6- 8
7	6.6- 7	3/8	9 - 9.6
8	7.6- 8	7/16	10.5-11.1
9	8.4- 9	1/2	12.1-12.7
10	9.4-10	9/16	13.5-14.3
10.5	9.9-10.5	5/8	15.2-16
11	10.4-11		
12	11.4-12		
14	13.2-14		
16	15.2-16		

**4211M / 4211A** ○ Screw and Stud Pullers Sets  
 Stehbolzendreher im Satz  
 Jeux d'extracteurs de goujons



**4211M** 4 Pieces Set/△=1,040g  
 METAL CASE:W215xH80xT47mm  
 PULLER  
 ○ 4100M Stud Pullers  
 6, 8, 10, 12

**4211A** 4 Pieces Set/△=1,040g  
 METAL CASE:W215xH80xT47mm  
 PULLER  
 ○ 4100A Stud Pullers  
 1/4, 5/16, 3/8, 1/2

**4214M** ○ Screw and Stud Pullers Set  
 Stehbolzendreher im Satz  
 Jeux d'extracteurs de goujons



**4214M** 5 Pieces Set/△=1,450g  
 METAL CASE:W215xH80xT47mm  
 PULLER  
 ○ 4100M Stud Pullers  
 6, 8, 10, 12, 14



6100M (mm)		D (mm)	L (mm)	H (mm)	(g)	(pcs.)
18	3/4"	48	100	36	840	1
20		48	100	36	816	1
22		48	100	36	745	1
24		48	100	36	739	1
27		63	125	46	1707	1
28		63	125	46	1701	1
29		63	125	46	1696	1
30		63	125	46	1691	1

\* Renewal Kits → 6100MRK → P307

6100M-22 to -30 do not have 3/4" square drive.  
Drive the outer hexagon part with sockets or ring wrenches  
(size 22-24mm = 36H, 27-30mm = 46H.)  
Die Stehbolzendreher ab Abmessung 22mm haben keinen 3/4" Antriebsvierkant.  
Bitte benutzen sie den Aussensechskant.

Tolerance

6100M (mm)	Tolerance
18	16.9-18
20	18.8-20
22	20.8-22
24	22.7-24
27	25.7-27
28	26.7-28
29	27.6-29
30	28.6-30

6100M Screw and Stud Pullers  
Stehbolzendreher  
Extracteurs de goujons

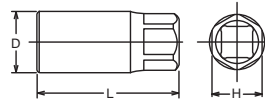

14100M (mm)		D <sub>1</sub> (mm)	D <sub>2</sub> (mm)	L (mm)	(g)	(pcs.)	
6	1/2"	24	25	48	126	10	*1
7		24	25	48	126	10	*1
8		24	25	48	122	10	*1
9		28	30	48	181	10	*2
10		28	30	48	181	10	*2
12		28	30	48	175	10	*2

14100A (inch)		D <sub>1</sub> (mm)	D <sub>2</sub> (mm)	L (mm)	(g)	(pcs.)	
1/4	1/2"	24	25	48	126	10	*1
5/16		24	25	48	122	10	*1
3/8		28	30	48	181	10	*2
7/16		28	30	48	181	10	*2
1/2		28	30	48	180	10	*2

\*1 C-Ring=1401C, Pin/O-Ring=1401A/B → P254-255  
\*2 C-Ring=1402C, Pin/O-Ring=1402A/B

Tolerance

14100M (mm)	Tolerance	14100A (inch)	Tolerance
6	5.6- 6	1/4	6 - 6.4
7	6.6- 7	5/16	7.6- 8
8	7.6- 8	3/8	9 - 9.6
9	8.4- 9	7/16	10.5-11.1
10	9.4-10	1/2	12.1-12.7
12	11.4-12		

14100M / 14100A IMPACT Screw and Stud Pullers  
IMPACT Stehbolzendreher  
Extracteurs de goujons IMPACT

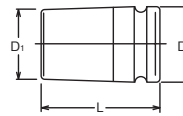

Stud Pullers & Setters  
 Stehbolzendreher  
 Extracteurs de goujons

Z-SERIES  
 HAND  
 TITANIUM  
 ACCESSORIES  
 SCREWDRIVERS  
 IMPACT  
 SLEEVE-DRIVE  
 PROTECTOR  
 INDUSTRIAL  
 AUTOMOTIVE  
 MOTORCYCLE  
 CONSTRUCTION  
 SPARE PART

**141S / 141** Stud Puller Ratchets  
 Stehbolzensausdreher-Knarren  
 Dégoujoneuses à cliquet



141S (mm)	D (mm)	L (mm)	(g)	(pce.)
6	28	120	150	1
8	28	120	150	1
10	32	120	153	1
12	32	120	152	1

141S (inch)	D (mm)	L (mm)	(g)	(pce.)
5/16	28	120	150	1
3/8	32	120	153	1
1/2	32	120	152	1

141 (mm)	D (mm)	L (mm)	(g)	(pce.)
6	28	205	215	1
8	28	205	215	1
10	32	205	234	1
12	32	205	233	1

141 (inch)	D (mm)	L (mm)	(g)	(pce.)
5/16	28	205	215	1
3/8	32	205	234	1
1/2	32	205	233	1

**141P** Stud Puller Ratchets  
 Stehbolzensausdreher-Knarren  
 Dégoujoneuses à cliquet

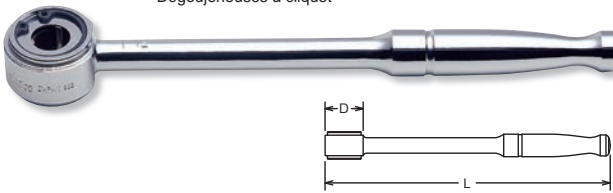

141P (mm)	D (mm)	L (mm)	(g)	(pce.)
6	28	205	210	1
8	28	205	210	1
10	32	205	229	1
12	32	205	227	1

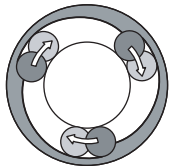

The three roller system can protect the studs from damage.  
 Das Drei-Rollen-System schützt die Stehbolzen.  
 Le système à trois roulettes n'endommage pas les goujons.



**1201** Stud Puller Ratchets  
 Stehbolzensausdreher-Knarren  
 Dégoujoneuses à cliquet



**1201** 4 Pieces Set/△=973g  
 METAL CASE:W240xH100xT32mm  
 PULLER  
 141S Stud Puller Ratchet  
 6, 8, 10, 12

**4104** Screw and Stud Puller  
 Stehbolzendreher  
 Extracteur de goujons



4104	□	Tolerance		D (mm)	L (mm)	(g)	(pcs.)
		min	max				
	1/2	φ 6	φ 19	54	56	489	2

4103M (mm)		D <sub>1</sub> (mm)	D <sub>2</sub> (mm)	H (mm)	L (mm)	(g)	(pcs.)
6(1.0)	1/2"	10.3	22	9	37	54	10
7(1.0)		11.5	22	10	37	58	10
8(1.25)		13.2	22	11	37	60	10
10(1.25)		15.3	23	13	44	86	10
10(1.5)		15.3	23	13	44	86	10
12(1.25)		17.8	23	14	44	86	10
12(1.75)		17.8	23	14	44	86	10



**4103M** Stud Bolt Setters  
Stehbolzensetzer  
Monte-goujons

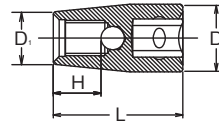

Depend on the stud bolt and using torque, 4103M/13103M/14103M may cause a scratch against the stud bolts or got stuck itself during a work.

**4203M** 4 Pieces Set/△=530g  
METAL CASE:W130xH65xT26mm  
Stud Bolt Setter  
 **4103M** Stud Bolt Setters  
6(1.0), 8(1.25), 10(1.5), 12(1.75)

**4203MF** 4 Pieces Set/△=530g  
METAL CASE:W130xH65xT26mm  
Stud Bolt Setter  
 **4103M** Stud Bolt Setters  
6(1.0), 8(1.25), 10(1.25), 12(1.25)

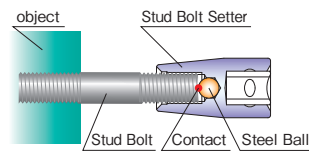

A special socket for installing a stud bolt.  
Inside steel ball prevents the stud bolt stuck onto the socket. After installing a stud bolt, turn to anti-clockwise to removing the socket.

Spezialwerkzeug zum Setzen von Stehbolzen. Der Bolzen trifft im Werkzeug nur auf die gehärtete Stahlkugel, was die Kontaktfläche verringert. Nach dem Setzen des Stehbolzens kann das Werkzeug im Linkslauf vom Stehbolzen abgezogen werden.

Douilles spéciales pour monter les goujons.  
Le goujon est en contact avec une bille d'acier pour l'empêcher d'adhérer à la douille.  
Après avoir posé le goujon, tourner dans le sens antihorlogique pour le retirer

**4203M** Stud Bolt Setters Set  
Stehbolzensetzer im Satz  
**4203MF** Jeu de monte-goujons



13103M (mm)		D <sub>1</sub> (mm)	D <sub>2</sub> (mm)	H (mm)	L (mm)	(g)	(pcs.)	
5(0.8)	3/8"	9.5	19	8	32	39	10	*1
6(1.0)		10.8	19	9	32	41	10	*1
7(1.0)		12.5	19	10	32	44	10	*1
8(1.25)		13.5	19	11	35	49	10	*1
10(1.25)		15.8	19	13	35	49	10	*1
10(1.5)		15.8	19	13	35	49	10	*1

\*1 C-Ring=1301C, Pin/O-Ring=1301A/B → P254-255

Depend on the stud bolt and using torque, 4103M/13103M/14103M may cause a scratch against the stud bolts or got stuck itself during a work.

**13103M** Impact Stud Bolt Setters  
Impact Stehbolzensetzer  
Monte-goujons Impact

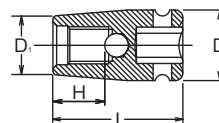

14103M (mm)		D <sub>1</sub> (mm)	D <sub>2</sub> (mm)	H (mm)	L (mm)	(g)	(pcs.)	
6(1.0)	1/2"	12	25	11	42	75	10	*1
7(1.0)		13.2	25	12	42	78	10	*1
8(1.25)		14.5	25	15	42	81	10	*1
10(1.25)		17	25	18	49	106	10	*1
10(1.5)		17	25	18	49	106	10	*1
12(1.25)		19.5	25	19	49	107	10	*1
12(1.75)		19.5	25	19	49	107	10	*1
14(1.5)	22	25	21	55	128	10	*1	
14(2.0)	22	25	21	55	128	10	*1	

\*1 C-Ring=1401C, Pin/O-Ring=1401A/B → P254-255

Depend on the stud bolt and using torque, 4103M/13103M/14103M may cause a scratch against the stud bolts or got stuck itself during a work.

**14103M** Impact Stud Bolt Setters  
Impact Stehbolzensetzer  
Monte-goujons Impact

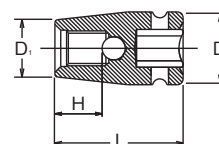

Tap Holder / Die Holder  
 Halter für Gewindeschneider / Halter für Gewindeschneideisen  
 Porte taraud / Porte-filière

Z-SERIES  
 HAND  
 TITANIUM  
 ACCESSORIES  
 SCREWDRIVERS  
 IMPACT  
 SLEEVE-DRIVE  
 PROTECTOR  
 INDUSTRIAL  
 AUTOMOTIVE  
 MOTORCYCLE  
 CONSTRUCTION  
 SPARE PART

**3131E** Tap Holder  
 Halter für Gewindeschneider  
 Porte taraud / porte-filière

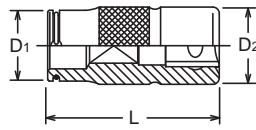

	3131E	□	D <sub>1</sub> (mm)	D <sub>2</sub> (mm)	L (mm)	(g)	(pcs.)
New	□2.1x	□2.8	6.8	18	40	45	10
New	□2.7x	□3.5	8	18	40	46	10
New	□3.4x	□4.5	9.5	18	40	47	10
New	□4.9x	□6	11.5	18	40	48	10
New	□5.5x	□7	12.5	18	40	49	10
New	□7 x	□9	15	18	40	48	10
New	□9 x	□11	17	18	40	48	10
New	□9 x	□12	18	18	40	48	10

For DIN352, DIN351, DIN2181, DIN5157 tap

**3264** Tap Holder set 10 pieces  
 Halter für Gewindeschneider im Satz  
 Jeu de portes taraud



3264		10 Pieces Set/ 1.050g	
METAL CASE:W240xH100xT32mm			
Sockets		Accessories	
3131E	□2.1x□2.8, □2.7x□3.5, □3.4x□4.5, □4.9x□6, □5.5x□7, □7x□9, □9x□11, □9x□12,		160K
			3760-125

**3131A** Adjustable Tap Holder  
 Halter für Gewindeschneider, einstellbar  
 Porte taraud, ajustable

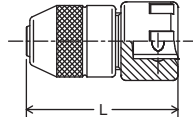

3131A	□	S(mm)		L (mm)	(g)	(pcs.)
		Min.	Max.			
1	□3/8"	2.0	5.0	42	80	5
2	□3/8"	4.5	8.0	47	100	5

S(mm)

Min.

Max.

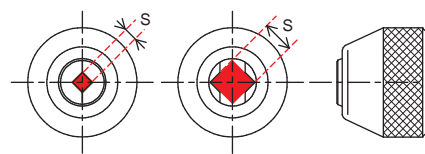

**160K** Reversible Ratchet  
 Verstellbare Knarre  
 Cliquet réversible

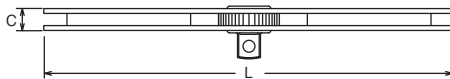

Tap is not included.  
 Gewindeschneider, nicht enthalten.  
 Taraud non inclus.

	□	C (mm)	L (mm)	(g)	(pce.)
160K	□3/8"	10	220	130	1
160K-1/2	□1/2"	10	220	135	1

**3132** Die Holder  
 Halter für Gewindeschneideisen  
**4132** Porte-filière

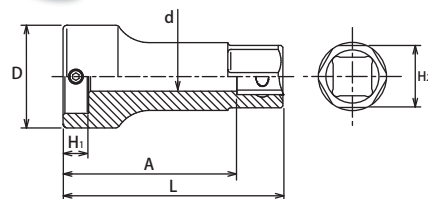

	□	D (mm)	H <sub>1</sub> (mm)	H <sub>2</sub> (mm)	d (mm)	A (mm)	L (mm)	(g)	(pcs.)
3132-20	□3/8"	28	7	17	8	45	60	130	5
4132-25		34	9	22	14	40	60	170	2
4132-38	□1/2"	48	13	24	18	60	80	315	2
4132-50		60	16	27	30	85	105	740	2



Die is not included.  
 Gewindeschneideisen, nicht enthalten.  
 Filière non inclus.

2127 (mm)	□	D <sub>1</sub> (mm)	D <sub>2</sub> (mm)	H (mm)	L (mm)	(g)	(pcs.)
4	1/4"	7	13	4	23	14	10
4.5		7.4	13	4	23	14	10
5		8	13	5	23	14	10
5.5		8.8	13	5	23	14	10
6		9.5	13	6	23	14	10
7		10.9	13	6	23	14	10
8		11.5	13	8	23	14	10
9		13	13	8	23	15	10
9.5		13.8	13	10	23	16	10
10		14.8	13	10	23	17	10



2127 ○ NUTTWISTER®

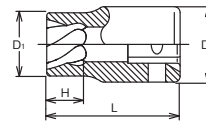

RS2127/6	6 Pieces Set/Rail 150mm	(g)
4, 4.5, 5, 5.5, 6, 7		105

RS2127/6 ○ ■■ Socket Set on Rail  
Steckschlüsselsatz auf Schiene  
Jeu de douilles sur rail



RS2127/10	10 Pieces Set/Rail 150mm	(g)
4, 4.5, 5, 5.5, 6, 7, 8, 9, 9.5, 10		180

RS2127/10 ○ ■■ Socket Set on Rail  
Steckschlüsselsatz auf Schiene  
Jeu de douilles sur rail



3127 (mm)	□	D <sub>1</sub> (mm)	D <sub>2</sub> (mm)	H (mm)	L (mm)	(g)	(pcs.)
8	3/8"	11.5	19	8	32	40	10
9		13	19	8	32	40	10
9.5		13.8	19	8	32	41	10
10		14.8	19	10	32	41	10
11		16	19	10	32	43	10
12		17	19	12	32	44	10
13		18.5	19	12	32	46	10
14		19.7	19	14	32	48	10
15		20.7	19	14	32	52	10
16		22.2	22	14	32	66	10
17	23.5	22	16	35	80	10	
19	26	22	16	35	92	10	

3127 ○ NUTTWISTER®

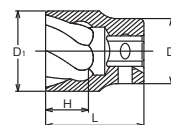

RS3127/8	8 Pieces Set/Rail 200mm	(g)
8, 9, 10, 11, 12, 13, 14, 16		420

RS3127/8 ○ ■■ Socket Set on Rail  
Steckschlüsselsatz auf Schiene  
Jeu de douilles sur rail



3128-80 (mm)	□	D <sub>1</sub> (mm)	D <sub>2</sub> (mm)	H (mm)	L (mm)	(g)	(pcs.)
8	3/8"	11.5	19	6	80	58	10
9		13	19	6	80	61	10
10		14.8	19	8	80	66	10
11		16	19	8	80	70	10
12		17	19	10	80	77	10
13		18.5	19	10	80	80	10
14		19.7	19	12	80	82	10

3128 (L80) ○ NUTTWISTER® (Long type)

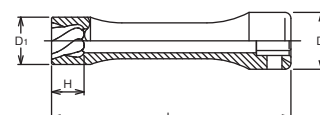

Z-SERIES  
HAND  
TITANIUM  
ACCESSORIES  
SCREWDRIVERS  
IMPACT  
SLEEVE-DRIVE  
PROTECTOR  
INDUSTRIAL  
AUTOMOTIVE  
MOTORCYCLE  
CONSTRUCTION  
SPARE PART

**4127**  NUTTWISTER®

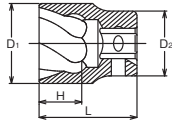

4127 (mm)		D <sub>1</sub> (mm)	D <sub>2</sub> (mm)	H (mm)	L (mm)	(g)	(pcs.)
14	1/2"	19.7	30	14	42	125	10
17		23.5	30	16	42	137	10
19		26	30	16	42	146	10
21		28	30	17	42	153	10
22		29.5	30	17	42	158	10
24		32	30	18	42	174	10
25.4		33.5	30	18	42	183	10

**RS4127/6**   Socket Set on Rail  
Steckschlüsselsatz auf Schiene  
Jeu de douilles sur rail



RS4127/6	6 Pieces Set/Rail 200mm	(g)
17, 19, 21, 22, 24, 25.4		960

**4128 (L120)**  NUTTWISTER® (Long type)

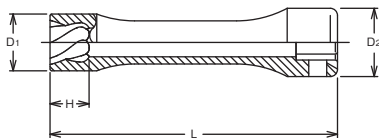

4128-120 (mm)		D <sub>1</sub> (mm)	D <sub>2</sub> (mm)	H (mm)	L (mm)	(g)	(pcs.)
17	1/2"	23.5	30	16	120	227	10
19		26	30	16	120	247	10
21		28	30	17	120	262	10
22		29.5	30	17	120	259	10

A very effective method and easy solution for removing rounded off nuts, bolts and studs. The sharp edges of the NUTTWISTER® Socket opening will tighten around the nut, bolt or stud and turn it easily off.

Eine einfache und wirkungsvolle Methode rund gedrehte Muttern und Bolzen herausdrehen bzw. zu öffnen.  
Die scharfen Kanten der gewundenen NUTTWISTER® Öffnung setzen sich um die Mutter bzw. den Schraubenkopf und drehen sie problemlos heraus.

Il existe une méthode simple mais efficace pour retirer les écrous et les boulons arrondis ainsi que les goujons et les dispositifs de verrouillage des jantes.  
Les arêtes vives de la douille NUTTWISTER® vont «mordre» l'écrou, le boulon ou le goujon et permettre ainsi facilement son extraction.



NUTTWISTER®

3129-32 (mm)		D <sub>1</sub> (mm)	D <sub>2</sub> (mm)	L (mm)	(g)	(pcs.)
2	3/8"	2	19	32	32	10
3		3	19	32	33	10
4		4	19	32	33	10
6		6	19	32	35	10
8		8	19	32	37	10
10		10	19	32	40	10

3129-60 (mm)		D <sub>1</sub> (mm)	D <sub>2</sub> (mm)	L (mm)	(g)	(pcs.)
2	3/8"	2	19	60	38	10
3		3	19	60	42	10
4		4	19	60	44	10
6		6	19	60	47	10
8		8	19	60	53	10
10		10	19	60	64	10

RS3129/6-L32	6 Pieces Set/Rail 150mm	(g)
2, 3, 4, 6, 8, 10		250

RS3129/6-L60	6 Pieces Set/Rail 150mm	(g)
2, 3, 4, 6, 8, 10		320

4129-37 (mm)		D <sub>1</sub> (mm)	D <sub>2</sub> (mm)	L (mm)	(g)	(pcs.)
8	1/2"	8	24	37	59	10
10		10	24	37	63	10
12		12	24	37	67	10
14		14	24	37	72	10
16		16	24	37	78	10

4129-75 (mm)		D <sub>1</sub> (mm)	D <sub>2</sub> (mm)	L (mm)	(g)	(pcs.)
8	1/2"	8	24	75	80	10
10		10	24	75	94	10
12		12	24	75	110	10
14		14	24	75	130	10
16		16	24	75	150	10

RS4129/5-L37	5 Pieces Set/Rail 150mm	(g)
8, 10, 12, 14, 16		370

RS4129/5-L75	5 Pieces Set/Rail 150mm	(g)
8, 10, 12, 14, 16		600



3129-32 / -60 BOLTTWISTER®

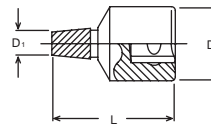

RS3129/6-L32 / -L60 Socket Set on Rail Steckschlüsselsatz auf Schiene Jeu de douilles sur rail



4129-37 / -75 BOLTTWISTER®

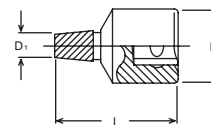

RS4129/5-L37 / -L75 Socket Set on Rail Steckschlüsselsatz auf Schiene Jeu de douilles sur rail

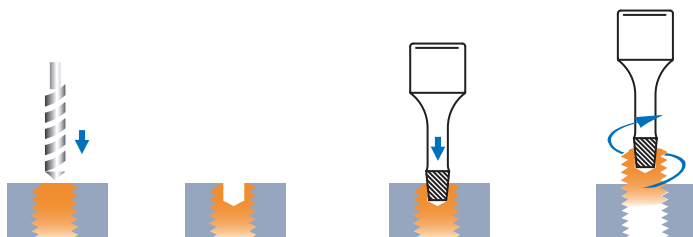

Effective method and easy solution for removing twisted off bolt. Drill a hole in the center of bolt and drive BOLTTWISTER® firmly into the hole. The sharp spiral edges will hold the broken bolt and easily remove it.

BOLTTWISTER	Bolt size	Drill size
2	M5	φ 2.4 ~ 2.6
3	M6	φ 3.2 ~ 3.5
4	M8	φ 4.2 ~ 4.5
6	M10 ~ M12	φ 6.2 ~ 6.5
8	M14 ~ M16	φ 8.2 ~ 8.5
10	M18 ~ M20	φ 10.2 ~ 10.5
12	M22 ~ M24	φ 12.2 ~ 12.5
14	M27 ~ M30	φ 14.2 ~ 14.5
16	M33	φ 16.2 ~ 16.5

# Ratcheting Ring Spanners

## Knarren-Ringschlüssel

### Clés hexagonales à cliquet

Z-SERIES  
HAND  
TITANIUM  
ACCESSORIES  
SCREWDRIVERS  
IMPACT  
SLEEVE-DRIVE  
PROTECTOR  
INDUSTRIAL  
AUTOMOTIVE  
MOTORCYCLE  
CONSTRUCTION  
SPARE PART

## 102NM / 102NA Without reverse lever Nicht umstellbar Non réversible

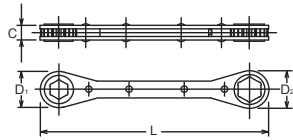

102NM (mm)	L (mm)	D <sub>1</sub> (mm)	D <sub>2</sub> (mm)	C (mm)	(g)	(pcs.)
6x7	108	15.3	16.4	7.5	60	10
7x8	108	15.3	16.4	7.5	60	10
8x9	134	17.1	19.7	7.5	80	10
8x10	134	17.1	19.7	7.5	80	10
10x11	140	20.1	22.7	7.5	87	10
10x12	140	20.1	22.7	7.5	87	10
11x13	145	23.6	24.6	9	112	10
12x13	145	23.6	24.6	9	112	10
12x14	145	23.6	24.6	9	112	10

102NA (inch)	L (mm)	D <sub>1</sub> (mm)	D <sub>2</sub> (mm)	C (mm)	(g)	(pcs.)
7/32 x 1/4	108	15.3	16.4	7.5	60	10
1/4 x 9/32	108	15.3	16.4	7.5	60	10
1/4 x 5/16	108	15.3	16.4	7.5	60	10
5/16 x 11/32	134	17.1	19.7	7.5	80	10
5/16 x 3/8	134	17.1	19.7	7.5	80	10
3/8 x 7/16	140	20.1	22.7	7.5	87	10
7/16 x 1/2	145	23.6	24.6	9	112	10
1/2 x 9/16	145	23.6	24.6	9	112	5

## 102KM / 102KA Reversible Umstellbar Réversible



102KM (mm)	L (mm)	D <sub>1</sub> (mm)	D <sub>2</sub> (mm)	C (mm)	(g)	(pcs.)
6x7	108	15.3	16.4	7.2	51	10
7x8	108	15.3	16.4	7.2	51	10
8x9	134	17	20	9.1	76	10
8x10	134	17	20	9.1	76	10
10x11	141	21	23.5	9.1	84	10
10x12	141	21	23.5	9.1	84	10
12x13	146	24	25	9.1	89	10
12x14	146	24	25	9.1	89	5
13x17	200	27.1	31.8	11.5	190	5
14x17	200	27.1	31.8	11.5	200	5

102KA (inch)	L (mm)	D <sub>1</sub> (mm)	D <sub>2</sub> (mm)	C (mm)	(g)	(pcs.)
7/32 x 1/4	108	15.3	16.4	7.2	51	10
1/4 x 5/16	108	15.3	16.4	7.2	51	10
5/16 x 11/32	134	17	20	9	76	10
3/8 x 7/16	141	21	23.5	9.1	84	10
1/2 x 9/16	146	24	25	9.1	89	5

## 102KM.BH With Twin Openings (Two-in-One) Doppel-Ringschlüssel (zwei Öffnungen in einer) Ouvertures doubles

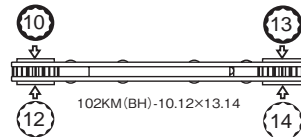

102KM.BH (mm)	L (mm)	D <sub>1</sub> (mm)	D <sub>2</sub> (mm)	C (mm)	(g)	(pcs.)
5.5- 6x 7- 8	108	15.3	16.4	10	60	10
8 -10x12-13	141	21	23.5	13	87	10
9 -10x11-12	141	21	23.5	13	87	10
10 -12x13-14	146	24	25	13	98	10
13 -14x15-17	200	27.1	31.8	16	200	5

## 102KT Reversible TORX® Umstellbar TORX® Réversible TORX®



102KT (E)	L (mm)	D <sub>1</sub> (mm)	D <sub>2</sub> (mm)	C (mm)	(g)	(pcs.)
E 4xE 6	108	15.3	16.4	7.5	51	10
E 6xE 8	108	15.3	16.4	7.5	51	10
E10xE12	134	17	20	9	76	10



103KM (mm)	L (mm)	D <sub>1</sub> (mm)	D <sub>2</sub> (mm)	C (mm)	(g)	(pcs.)
6x 7	108	15.3	16.4	7.5	51	5
7x 8	108	15.3	16.4	7.5	51	5
8x 9	134	17	20	9	76	5
8x10	134	17	20	9	76	5
10x11	140	21	23.5	9	84	5
10x12	140	21	23.5	9	84	5
12x13	145	24	25	9	89	5
12x14	145	24	25	9	89	5

103KA (inch)	L (mm)	D <sub>1</sub> (mm)	D <sub>2</sub> (mm)	C (mm)	(g)	(pcs.)
7/32x 1/4	108	15.3	16.4	7.5	51	5
1/4 x 5/16	108	15.3	16.4	7.5	51	5
5/16x11/32	134	17	20	9	76	5
5/16x 3/8	134	17	20	9	76	5
3/8 x 7/16	140	21	23.5	9	84	5
7/16x 1/2	145	24	25	9	89	5
1/2 x 9/16	145	24	25	9	89	5

103KA.BH (inch)	L (mm)	D <sub>1</sub> (mm)	D <sub>2</sub> (mm)	C (mm)	(g)	(pcs.)
1/4x5/16	108	15.3	16.4	7.5	51	5
3/8x7/16	140	21	23.5	9	84	5
1/2x9/16	145	24	25	9	89	5

103KT (E)	L (mm)	D <sub>1</sub> (mm)	D <sub>2</sub> (mm)	C (mm)	(g)	(pcs.)
E 4xE 6	104	15.3	16.4	7.5	51	5
E 6xE 8	104	15.3	16.4	7.5	51	5
E10xE12	128	17	20	9	76	5
E14xE16	139	24	25	9	89	5

145KM (mm)	L (mm)	D (mm)	C (mm)	(g)	(pcs.)
10H	125	20.1	7.5	72	10



150-10H (mm)	D (mm)	H (mm)	L (mm)	(g)	(pcs.)
5	12	3.5	11	6	10
6	12	4.5	12.5	7	10
7	12	5	14	7	10
8	12	6	15.5	7	10
9	13	6	16	7	10
10	14.3	7	17	9	10
12	17.4	9	19.5	14	10

1203		7 Pieces Set/△=250g
METAL CASE:W130xH65xT20mm		
Sockets		Accessory
○ 150.10H	5, 6, 7, 8, 9, 10	🔧 145KM-10H

**103KM / 103KA** ○ Reversible  
Umstellbar  
Réversible

**103KA.BH** ○ Reversible (12P)  
Umstellbar (12P)  
Réversible (12P)

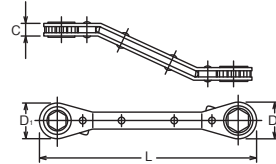

**103KT** ○ Reversible TORX®  
Umstellbar TORX®  
Réversible TORX®

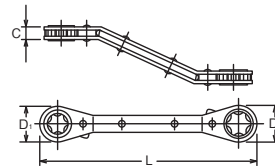
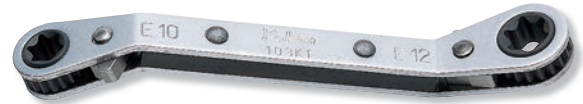

**145KM-10H** ○ Reversible, 10mm 6-pt.  
Verstellbar SW10mm  
Réversible 10mm

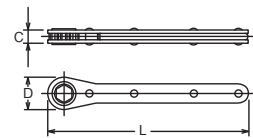

**150-10H** ○ Sockets with 10mm 6-point Drive End  
Steckschlüssel mit 10mm Sechskant-Antrieb  
Douilles à conducteur de 10mm 6-pans mâle

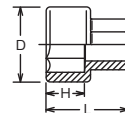

**1203** ○ Sockets with 10mm 6-point Drive End in Set with Ratchet  
Steckschlüssel mit 10mm Sechskant-Antrieb mit Knarre im Satz  
Jeu de douilles à conducteur 10mm 6-pans mâle, avec cliquet





Ratcheting Ring Spanners  
 Knarren-Ringschlüssel  
 Clés hexagonales à cliquet

Z-SERIES  
 HAND  
 TITANIUM  
 ACCESSORIES  
 SCREWDRIVERS  
 IMPACT  
 SLEEVE-DRIVE  
 PROTECTOR  
 INDUSTRIAL  
 AUTOMOTIVE  
 MOTORCYCLE  
 CONSTRUCTION  
 SPARE PART

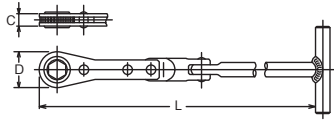

**154M**  Push and Pull-Ratchets  
 Hub-Knarren  
 Clé à cliquet de levage



154M (mm)	L (mm)	D (mm)	C (mm)	 (g)	 (pcs.)
8	294	17.1	7.5	178	2
10	297	20.1	7.5	183	2
12	300	23.6	9	189	2
13	301	24.6	9	194	2
14	301	24.6	9	194	2



**154ML**  Push and Pull-Ratchets  
 Hub-Knarren  
 Clé à cliquet de levage

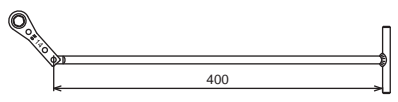

154ML (mm)	L (mm)	D (mm)	C (mm)	 (g)	 (pcs.)
10	297	20.1	7.5	230	2
12	300	23.6	9	252	2

**1206**  Push and Pull-Ratchet  
 Hub-Knarre  
 Clé à cliquet de levage



1206		3 Pieces Set/  =320g
CARDBOARD BOX		
Sockets		Accessory
 150.14H Sockets 12, 14	154K-14	

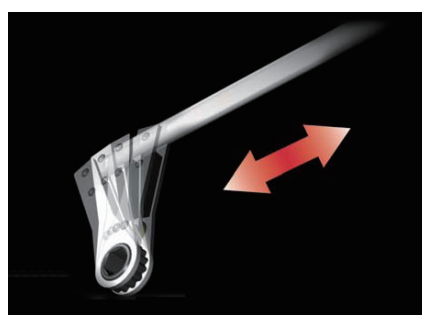

# Ratcheting Ring Spanners Knarren-Ringschlüssel Clés hexagonales à cliquet

137	L (mm)	D <sub>1</sub> (mm)	D <sub>2</sub> (mm)	C (mm)	(g)	(pcs.)
	141	23.5	21	9	104	5

1/4" × 3/8"

138	L (mm)	D <sub>1</sub> (mm)	D <sub>2</sub> (mm)	C (mm)	(g)	(pcs.)
	141	23.5	21	9	97	10

1/4" × 1/4"

139	L (mm)	D (mm)	C (mm)	(g)	(pcs.)
	125	20.1	7.5	80	10

1/4"

R810 (inch)	L (mm)	D <sub>1</sub> (mm)	D <sub>2</sub> (mm)	C (mm)	(g)	(pcs.)
1/4×5/16	108	15.3	16.4	7.5	60	10
3/8×7/16	140	20.1	22.7	7.5	87	10
1/2×9/16	145	23.6	24.6	9	112	10

**137**  For 1/4" and 3/8" Square Drive Sockets  
Für Steckschlüssel mit 1/4" und 3/8" Antrieb  
Pour douilles d'un carré conducteur de 1/4" et 3/8"

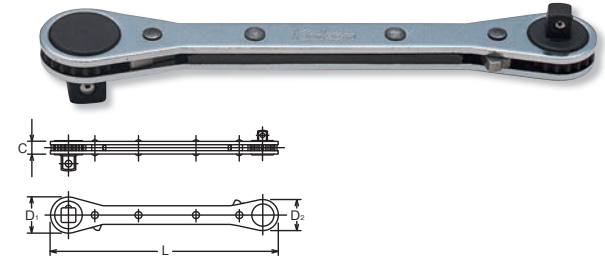

**138**  For Bits 101  
Für Klängen 101  
Pour embouts 101

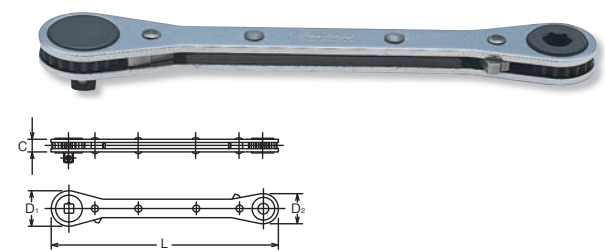

**139**  For 1/4" Square Drive Sockets  
Für Steckschlüssel mit 1/4" Antrieb  
Pour douilles d'un carré conducteur de 1/4"

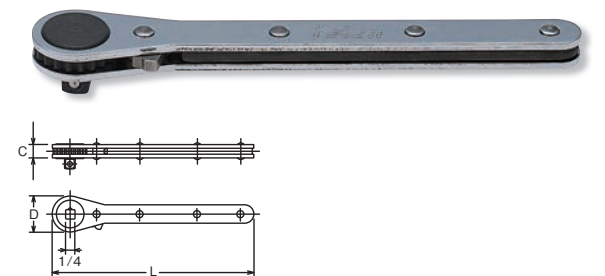

**R810**  Reversible (12P)  
Umstellbar (12P)  
Réversible (12P)

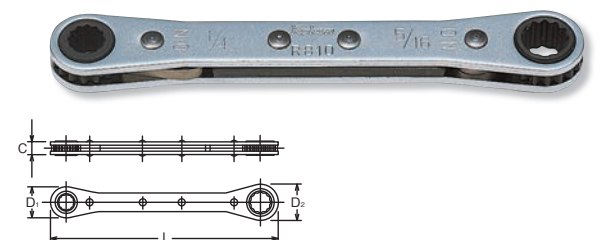

# Ratcheting Ring Spanners

## Knarren-Ringschlüssel

### Clés hexagonales à cliquet

Z-SERIES  
HAND  
TITANIUM  
ACCESSORIES  
SCREWDRIVERS  
IMPACT  
SLEEVE-DRIVE  
PROTECTOR  
INDUSTRIAL  
AUTOMOTIVE  
MOTORCYCLE  
CONSTRUCTION  
SPARE PART

#### 101P PH Bits PH Bits Embouts, PH

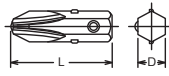

101P (PH)	D (mm)	L (mm)	(g)	(pcs.)
1	6.35	20.5	3	10
2	6.35	20.5	4	10
3	6.35	20.5	5	10

#### 101S Slotted Bits Schlitz Bits Embouts, fente

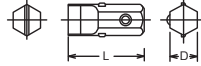

101S	D (mm)	L (mm)	(g)	(pcs.)
1.0x7	6.35	15	3	10
1.2x7	6.35	15	3	10

#### 101H Hex Bits Sechskant Bits Embouts, 6 pans creux

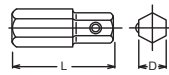

101H (mm)	D (mm)	L (mm)	(g)	(pcs.)
3	6.35	20.5	5	10
4	6.35	20.5	5	10
5	6.35	20.5	5	10
6	6.35	20.5	5	10
7	6.35	20.5	6	10
8	6.35	20.5	7	10

#### 101B Ball-point Hex Bits Sechskant Bits Embouts, 6 pans creux

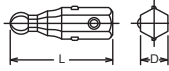

101B (mm)	D (mm)	L (mm)	(g)	(pcs.)
3	6.35	25	4	10
4	6.35	25	4	10
5	6.35	25	5	10
6	6.35	25	5	10

 Ball point bits have less strength due to the special design. Make sure to use them correctly.

#### 101T (T) TORX® Bits TORX® Bits Embouts, TORX®

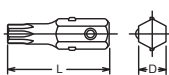

101T (T)	D (mm)	L (mm)	(g)	(pcs.)
T 9	6.35	25	4	10
T10	6.35	25	4	10
T15	6.35	25	5	10
T20	6.35	25	5	10
T25	6.35	25	5	10
T27	6.35	25	6	10
T30	6.35	25	6	10

#### 101T (TH) Tamper-Resistant TORX® Bits TORX® Bits Embouts, TORX®

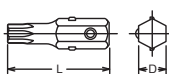

101T (TH)	D (mm)	L (mm)	(g)	(pcs.)
T10H	6.35	25	4	10
T15H	6.35	25	4	10
T20H	6.35	25	5	10
T25H	6.35	25	5	10
T27H	6.35	25	6	10
T30H	6.35	25	6	10

 Tamper Resistant TORX® Bits have less strength due to special design. Make sure to use it correctly.

128H (mm)	D (mm)	L (mm)	(g)	(pcs.)
3	8	32	11	10
4	8	32	11	10
5	8	32	12	10
6	8	32	12	10
8	8	32	13	10

128T (T)	D (mm)	L (mm)	(g)	(pcs.)
T10	8	32	9	10
T15	8	32	9	10
T20	8	32	9	10
T25	8	32	10	10
T27	8	32	10	10
T30	8	32	11	10

101A	D (mm)	S (mm)	L (mm)	(g)	(pcs.)
	8	6.35	20	8	10

1202		15 Pieces Set/ 420g
METAL CASE:W190xH60xT30mm		
Bits	Accessory	
<b>101P</b> Phillips Bits 1, 2, 3 <b>101S</b> Slotted Bit 1x7 <b>101B</b> Ballpoint Hex Bits 3, 4, 5, 6 <b>101T</b> TORX® Bits T10, T15, T20, T25, T27, T30	<b>138</b>	

2254M		12 Pieces Set/ 450g
METAL CASE:W160xH100xT28mm		
Bits	Accessories	
<b>101P</b> Phillips Bits 1, 2, 3 <b>101S</b> Slotted Bits 1x7, 1.2x7 <b>101H</b> Hex Bits 3, 4, 5	<b>102NA-1/4x5/16</b> <b>2769F</b> <b>101A</b> <b>2137</b>	

**128H** Hex Bits  
 Sechskant Bits  
 Embouts, 6 pans creux



**128T** TORX® Bits  
 TORX® Bits  
 Embouts, TORX®



**101A** Adaptor  
 Verbindungsstück  
 Adaptateur



**1202** Bit Set  
 Bit-Satz  
 Jeu d'embouts



**2254M** Bit Set  
 Bit-Satz  
 Jeu d'embouts



# Ratcheting Ring Spanners Knarren-Ringschlüssel Clés hexagonales à cliquet

Z-SERIES  
HAND  
TITANIUM  
ACCESSORIES  
SCREWDRIVERS  
IMPACT  
SLEEVE-DRIVE  
PROTECTOR  
INDUSTRIAL  
AUTOMOTIVE  
MOTORCYCLE  
CONSTRUCTION  
SPARE PART

**R810A** Bit Set  
Bit-Satz  
Jeu d'embouts



<b>R810A</b> 5 Pieces Set/△=208g	
METAL CASE:W130xH65xT20mm	
Bits	Accessory
<b>101P</b> Phillips Bits 1, 2, 3 <b>101S</b> Slotted Bit 1x7	<b>102NA-1/4x5/16</b>

**R810B** Bit Set  
Bit-Satz  
Jeu d'embouts



<b>R810B</b> 10 Pieces Set/△=268g	
METAL CASE:W130xH65xT20mm	
Bits	Accessory
<b>101P</b> Phillips Bits 1, 2, 3 <b>101S</b> Slotted Bit 1x7 <b>128H</b> Hex Bits 3, 4, 5, 6, 8	<b>102NA-1/4x5/16</b>

**R810C** Bit and Socket Set  
Bit und Steckschlüssel Satz  
Jeu de douilles et d'embouts



<b>R810C</b> 12 Pieces Set/△=227g	
METAL CASE:W130xH65xT20mm	
Bits, Sockets	Accessories
<b>101P</b> Phillips Bits 1, 2, 3 <b>101S</b> Slotted Bit 1x7 <b>2400M</b> Sockets 5, 6, 7, 8, 9, 10	<b>102NA-1/4x5/16</b> <b>101A</b>

**R810D** Bit and Socket Set  
Bit und Steckschlüssel Satz  
Jeu de douilles et d'embouts



<b>R810D</b> 17 Pieces Set/△=336g	
METAL CASE:W130xH65xT20mm	
Bits, Sockets	Accessories
<b>101P</b> Phillips Bits 1, 2, 3 <b>101S</b> Slotted Bit 1x7 <b>128H</b> Hex Bits 3, 4, 5, 6, 8 <b>2400M</b> Sockets 5, 6, 7, 8, 9, 10	<b>102NA-1/4x5/16</b> <b>101A</b>

**R810E** Socket Set  
Steckschlüssel Satz  
Jeu de clés à douilles



<b>R810E</b> 9 Pieces Set/△=445g	
METAL CASE:W130xH65xT20mm	
Sockets	Accessories
<b>2300M</b> Deep Sockets 6, 7, 8, 9, 10, 11, 12	<b>102NA-1/4x5/16</b> <b>101A</b>



**156M**  6-Point Deep  
6-kant, lang  
Longues 6-pans

156M (mm)	D (mm)	H <sub>1</sub> (mm)	H <sub>2</sub> (mm)	L <sub>1</sub> (mm)	L <sub>2</sub> (mm)	(g)	(pce.)
8	12	9	41	355	200	231	1
10	14.5	11	41	355	200	289	1
12	16.8	13	41	355	200	429	1
14	20	16	41	355	200	454	1

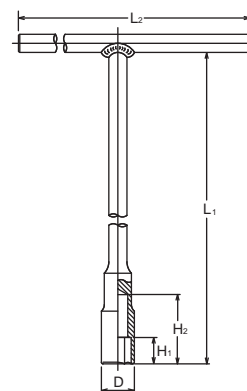

**104ME / 104A**  6-Point  
6-kant  
6-pans

104ME (mm)	D (mm)	H (mm)	L <sub>1</sub> (mm)	L <sub>2</sub> (mm)	(g)	(pce.)
6	9.5	8	200	180	150	1
7	11	9	200	180	152	1
8	12	10	250	200	183	1
9	14	12	250	200	188	1
10	14	13	250	200	230	1
11	16	14	250	200	234	1
12	18	15	250	200	355	1
13	18.5	17	250	250	390	1
14	20	18	250	250	399	1
15	21	19	250	250	404	1
16	22.5	21	250	250	419	1
17	24	22	250	250	568	1
18	25	23	250	250	577	1
19	26.5	25	250	250	594	1

104A (inch)	D (mm)	H (mm)	L <sub>1</sub> (mm)	L <sub>2</sub> (mm)	(g)	(pce.)
1/4	9.5	8	200	180	150	1
5/16	12	10	250	200	183	1
3/8	14	12	250	200	188	1
7/16	16	14	250	200	234	1
1/2	18.5	17	300	250	412	1
9/16	20	18	300	250	428	1
5/8	22.5	21	350	300	528	1
3/4	26.5	25	350	300	717	1

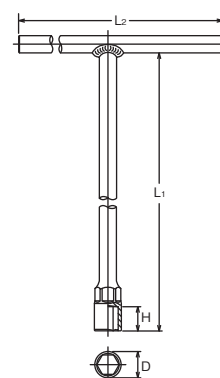
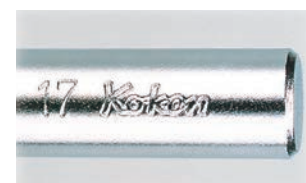

Z-SERIES  
HAND  
TITANIUM  
ACCESSORIES  
SCREWDRIVERS  
IMPACT  
SLEEVE-DRIVE  
PROTECTOR  
INDUSTRIAL  
AUTOMOTIVE  
MOTORCYCLE  
CONSTRUCTION  
SPARE PART

**3116M**  Universal with 6-point Socket  
Gelenk mit 6-kant Steckschlüssel  
Cardan avec douille 6-pans



**124M-600 (2B)**

 Ball Joint plus Nut Grip Socket  
Kugelgelenk mit 2-facher Kugelhalterung  
Douilles articulées avec deux billes de retenue

3116M (mm)	D (mm)	H (mm)	L <sub>1</sub> (mm)	L <sub>2</sub> (mm)	(g)	(pce.)
10	14.5	8	800	190	796	1
12	17	10.3	800	190	797	1
13	18	11.3	800	190	797	1
14	19.5	11.3	800	190	797	1
15	21	12.8	800	190	799	1
16	22	12.8	800	190	806	1
17	23.6	13.8	800	190	801	1
18	24	13.8	800	190	809	1

124M-600 (mm)	D (mm)	H (mm)	L <sub>1</sub> (mm)	L <sub>2</sub> (mm)	(g)	(pce.)
8(2B)	12	5	600	200	332	1
10(2B)	14.5	6	600	200	334	1
12(2B)	16.8	7	600	200	424	1
13(2B)	18	8	600	200	425	1
14(2B)	19.5	8.5	600	200	527	1
17(2B)	23.3	9.5	600	200	538	1

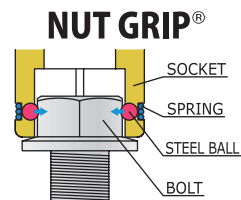

**NUT GRIP®**

Twin balls at the 6-point opening hold bolt/nut tightly for safe and reliable work.

Die zwei Kugeln in der 6-kant Öffnung unserer NUT GRIP Steckschlüssel halten die Schraube sicher im Steckschlüssel. Dies erlaubt ein Arbeiten auch an schwer zugänglichen Stellen.

Les 2 billes dans l'ouverture du 6-pans de la douille retiennent l'écrou de manière sûre et efficace.

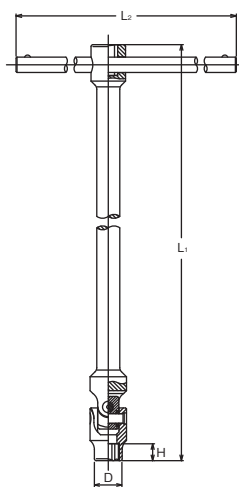

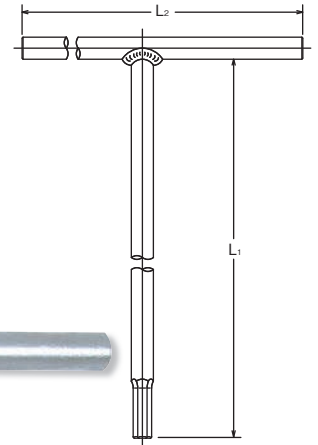

photo: 3116M



**157HE**  For Inhex Screws  
Für Innensechskant-Schrauben  
Pour vis à 6-pans creux

157HE (mm)	L <sub>1</sub> (mm)	L <sub>2</sub> (mm)	(g)	(pce.)
3	250	180	98	1
4	250	180	121	1
5	250	180	158	1
6	250	180	416	1
8	250	180	422	1
10	300	190	440	1
12	320	210	660	1



**157T**  For TORX® Screws  
Für TORX®-Schrauben  
Pour vis TORX®

157T (T)	L <sub>1</sub> (mm)	L <sub>2</sub> (mm)	(g)	(pce.)
T25	250	180	95	1
T27	250	180	96	1
T30	250	180	167	1
T40	250	180	168	1
T45	250	180	213	1
T50	250	180	215	1



**157S**  For Slotted Heads  
Für Schlitzschrauben  
Pour vis à fente

157S	TxW	L <sub>1</sub> (mm)	L <sub>2</sub> (mm)	(g)	(pce.)
6	1.0x6	200	180	84	1
8	1.2x8	250	180	170	1



**157PE**  For Phillips Screws  
Für Kreuzschlitzschrauben, Phillips  
Pour vis à empreinte Phillips

157PE (PH)	L <sub>1</sub> (mm)	L <sub>2</sub> (mm)	(g)	(pce.)
2	250	180	95	1
3	250	180	170	1

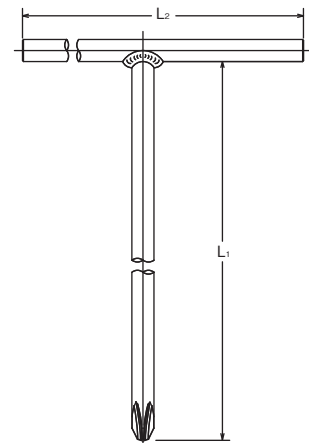
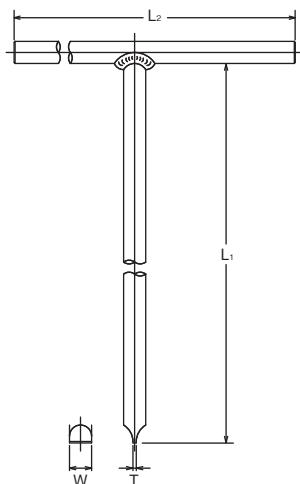
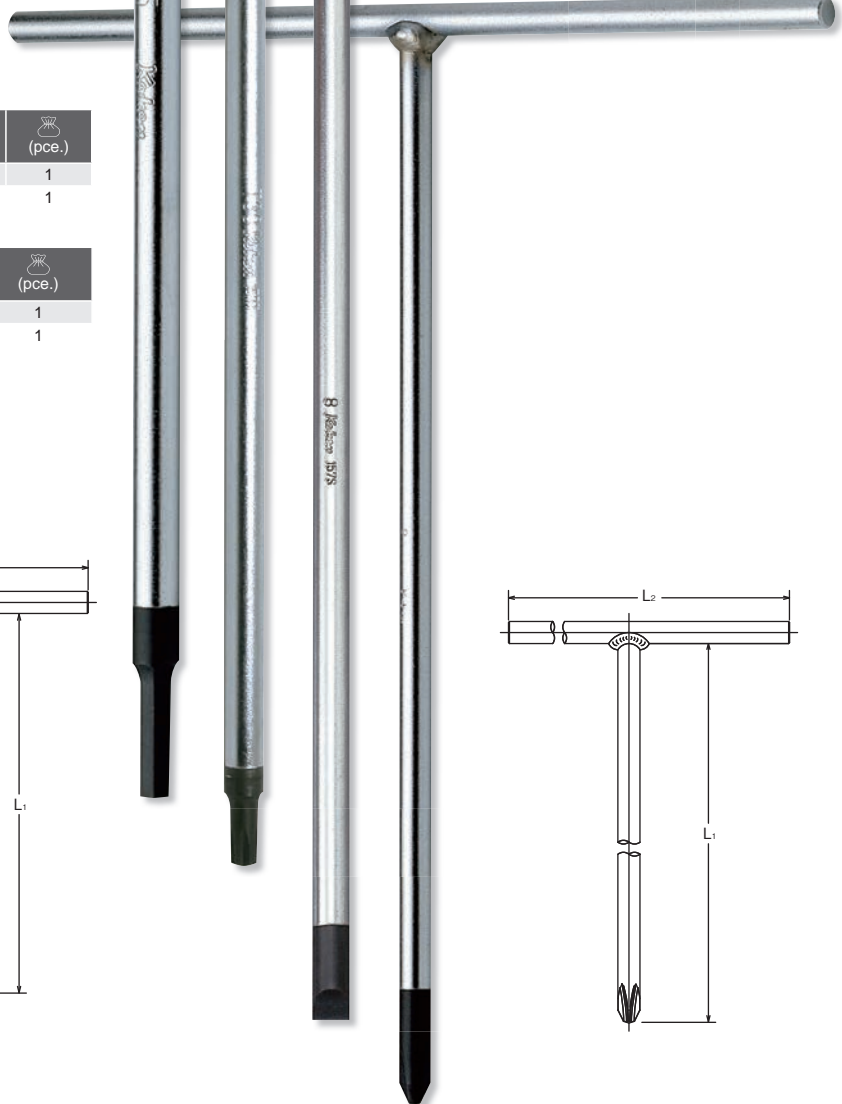

T-Handles  
T-Griffe  
Poignées en T

Z-SERIES  
HAND  
TITANIUM  
ACCESSORIES  
SCREWDRIVERS  
IMPACT  
SLEEVE-DRIVE  
PROTECTOR  
INDUSTRIAL  
AUTOMOTIVE  
MOTORCYCLE  
CONSTRUCTION  
SPARE PART

**2715**  T-Handle  
T-Griff  
Poignée coulissante



**3715**  T-Handle  
T-Griff  
Poignée coulissante



**3715S**  T-Handle  
T-Griff  
Poignée coulissante



**3715SL**  T-Handle  
T-Griff  
Poignée coulissante







**3715SLK**  T-Handle  
T-Griff  
Poignée coulissante

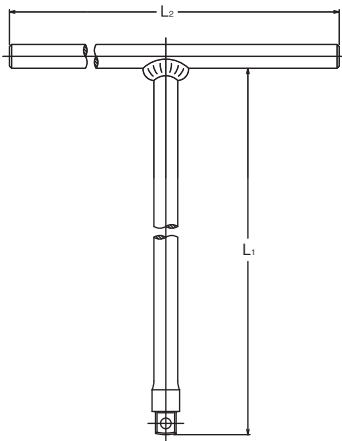

**3716**  T-Handle  
T-Griff  
Poignée coulissante



		L <sub>1</sub> (mm)	L <sub>2</sub> (mm)	 (g)	 (pce.)
<b>2715</b>		200	120	130	1

		L <sub>1</sub> (mm)	L <sub>2</sub> (mm)	 (g)	 (pce.)
<b>3715</b>		268	240	386	1
<b>3715S</b>		268	190	347	1
<b>3715SL</b>		237	200	325	1
<b>3715SLK</b>		236	200	470	1
<b>3716</b>		268	240	379	1

3716  
3716 has a reduced square drive and similar function as offset extension bars.



photo: 3715SLK



**4715**  T-Handle  
T-Griff  
Poignée coulissante







**4715S**  T-Handle  
T-Griff  
Poignée coulissante

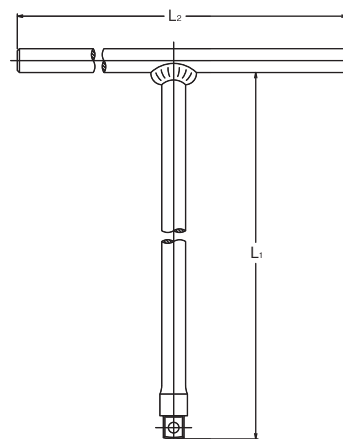

**4715SL**  T-Handle  
T-Griff  
Poignée coulissante



		L <sub>1</sub> (mm)	L <sub>2</sub> (mm)	 (g)	 (pce.)
4715		267	255	475	1
4715S		267	170	402	1
4715SL		250	250	640	1

**4711X**  Spinning cross wrench  
T-Griff für die Radmuttermontage  
Poignée coulissante pour montage des écrous à roue

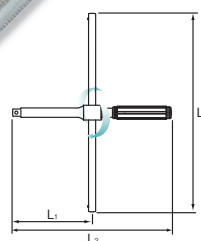
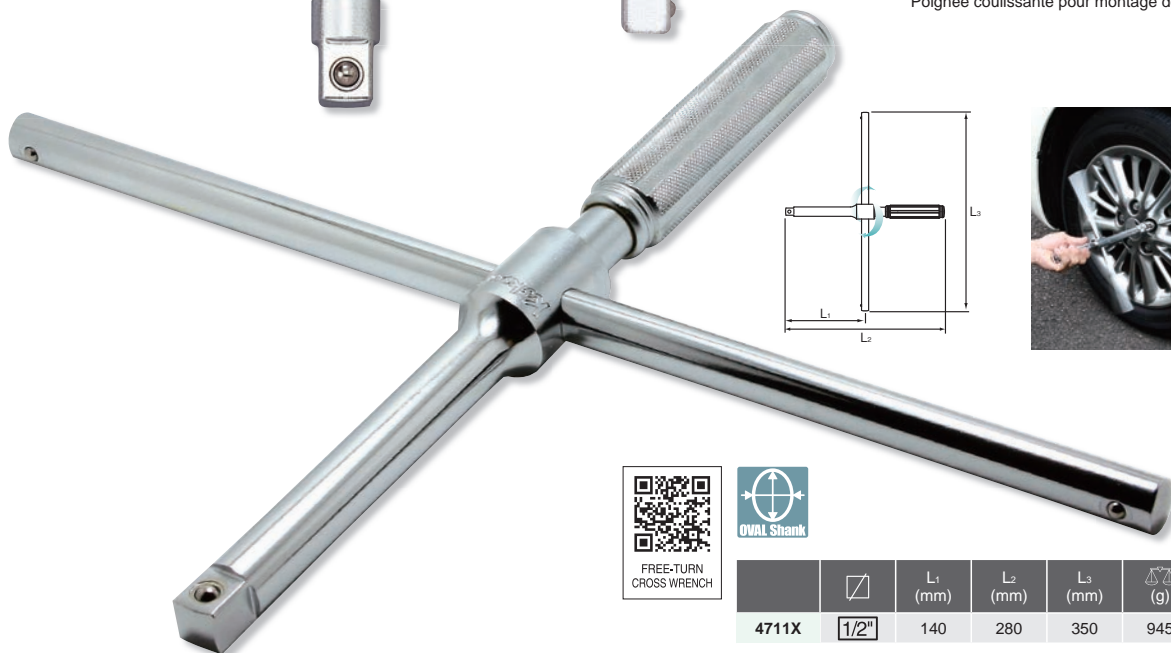

		L <sub>1</sub> (mm)	L <sub>2</sub> (mm)	L <sub>3</sub> (mm)	 (g)	 (pce.)
4711X		140	280	350	945	1

# Attack Drivers

## Hand-Schlagschrauber

### Tournevis à frapper

Z-SERIES  
HAND  
TITANIUM  
ACCESSORIES  
SCREWDRIVERS  
IMPACT  
SLEEVE-DRIVE  
PROTECTOR  
INDUSTRIAL  
AUTOMOTIVE  
MOTORCYCLE  
CONSTRUCTION  
SPARE PART

**3112G** Attack Driver  
Handschlagschrauber  
Tournevis à frapper



	□	L (mm)	⚖ (g)	📦 (pce.)
<b>3112G</b>	3/8"	159	810	1

\* Renewal Kits → **3112RK** → P306

**4112G** Attack Driver  
Handschlagschrauber  
Tournevis à frapper



	□	L (mm)	⚖ (g)	📦 (pce.)
<b>4112G</b>	1/2"	163	810	1
<b>4112N</b>	1/2"	163	730	1

\* Renewal Kits → **4112RK** → P306

**4112N** Attack Driver  
Handschlagschrauber  
Tournevis à frapper



	□	L (mm)	⚖ (g)	📦 (pce.)
<b>6112</b>	3/4"	190	1900	1

\* Renewal Kits → **6112RK** → P306



Black finished striking head prevents the problem of peeling.  
Das geschwärzte Schlagende vermeidet das Abspringen von Chromteilen.  
La finition "black finish" de la tête évite l'écaillage du au chromage.

**6112** Attack Driver  
Handschlagschrauber  
Tournevis à frapper



ATTACK DRIVER®

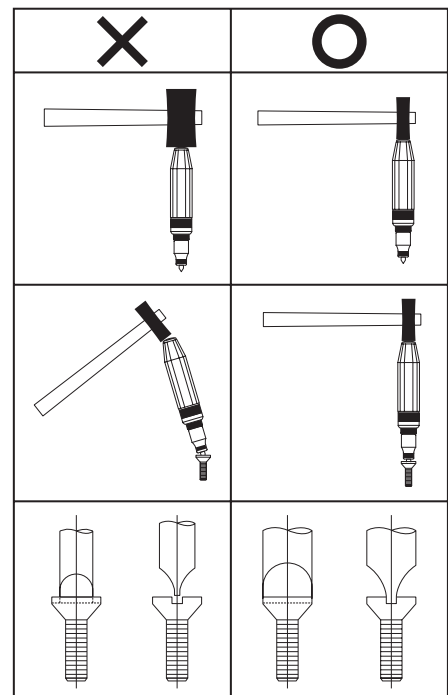

**AG318A** 6 Pieces Set/△=1,150g

METAL CASE:W220xH82xT60mm

Bits	Accessories
<b>100P.32</b> Phillips Bits 2, 3	<b>3112G</b>
<b>100S.32</b> Slotted Bits 9, 11	<b>3138</b>

**AG112A** 6 Pieces Set/△=1,150g

METAL CASE:W220xH82xT60mm

Bits	Accessories
<b>100P.32</b> Phillips Bits 2, 3	<b>4112G</b>
<b>100S.32</b> Slotted Bits 9, 11	<b>4138</b>

100P, S Bits → P158

**AG112H** 18 Pieces Set/△=1,480g

METAL CASE:W220xH82xT60mm

Bits	Accessories
<b>100P.32</b> Phillips Bits 2, 3, 4	<b>4112G</b>
<b>100S.32</b> Slotted Bits 8, 9, 10, 12, 14	<b>4138</b>
<b>100H.32</b> Hex Bits 5, 6, 8, 10	
<b>100T.32</b> TORX® Bits T30, T40, T45, T50	

100P, S, H, T Bits → P158

**AG112F** 25 Pieces Set/△=1,530g

METAL CASE:W220xH82xT60mm

Bits	Accessories
<b>100P.32</b> Phillips Bits 2, 3	<b>4112G</b>
<b>100P.32</b> PZ Bits PZ2, PZ3	<b>4138</b>
<b>100S.32</b> Slotted Bits 9, 11	
<b>100H.32</b> Hex Bits 4, 5, 6, 7, 8, 10	
<b>100T.32</b> TORX® Bits T25, T27, T30, T40, T45, T50	
<b>100X.32</b> XZN Bits M5, M6, M8, M10, M12	

100P, S, H, T, X Bits → P158-159

**AN112A** 6 Pieces Set/△=1,070g

METAL CASE:W190xH59xT45mm

Bits	Accessories
<b>100P.32</b> Phillips Bits 2, 3	<b>4112N</b>
<b>100S.32</b> Slotted Bits 9, 11	<b>4138</b>

100P, S Bits → P158

**AN112C** 8 Pieces Set/△=1,350g

METAL CASE:W220xH82xT60mm

Bits	Accessories
<b>100P.80</b> Phillips Bits 1, 2, 3	<b>4112N</b>
<b>100S.80</b> Slotted Bits 7, 9, 12	<b>4138</b>

100P, S Bits → P158

**AG318A** Attack Driver Set  
Handschlagschrauber-Satz  
Jeu de tournevis à frapper



**AG112H** Attack Driver Set  
Handschlagschrauber-Satz  
Jeu de tournevis à frapper

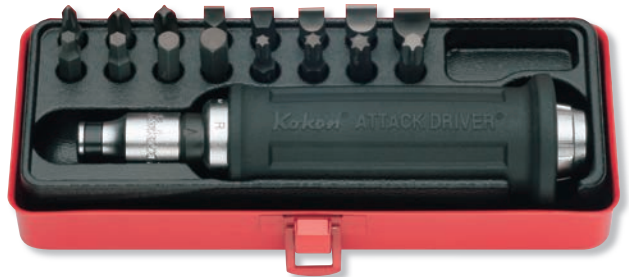

**AG112F** Attack Driver Set  
Handschlagschrauber-Satz  
Jeu de tournevis à frapper



**AN112A** Attack Driver Set  
Handschlagschrauber-Satz  
Jeu de tournevis à frapper



**AN112C** Attack Driver Set  
Handschlagschrauber-Satz  
Jeu de tournevis à frapper

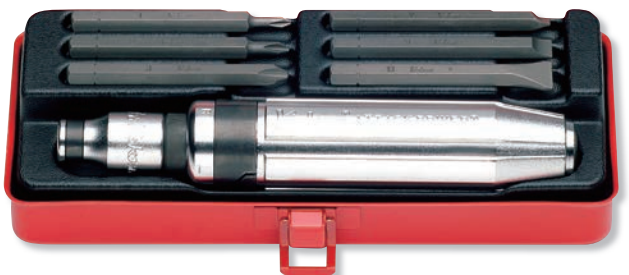

Z-SERIES  
HAND  
TITANIUM  
ACCESSORIES  
SCREWDRIVERS  
IMPACT  
SLEEVE-DRIVE  
PROTECTOR  
INDUSTRIAL  
AUTOMOTIVE  
MOTORCYCLE  
CONSTRUCTION  
SPARE PART

**108P-25 / -32 / -50**  PH Bits  
PH Bits  
Embouts, PH

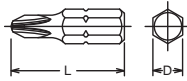

**108S-25 / -39**  Slotted Bits  
Schlitz Bits  
Embouts, fente

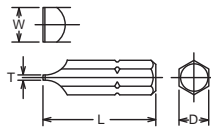

**108H-25**  Hex Bits  
Sechskant Bits  
Embouts, 6 pans creux

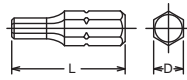

**108T-25 (T)**  TORX® Bits  
TORX® Bits  
Embouts, TORX®

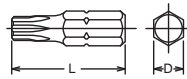

**108T-25 (TH)**  Tamper-Resistant TORX® Bits  
Tamper-Resistant TORX® Bits  
Embouts TORX®, Tamper-Resistant 

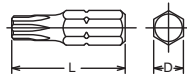

 Tamper Resistant TORX® Bits have less strength due to special design.  
Make sure to use it correctly.

**108A**  Adaptor  
Verbindungsstück  
Adaptateur

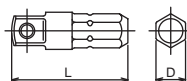

108P-25 (PH)	D (mm)	L (mm)	(g)	(pcs.)
1	6.35	25	5	10
2	6.35	25	5	10
3	6.35	25	6	10

108P-32 (PH)	D (mm)	L (mm)	(g)	(pcs.)
1	6.35	32	7	10
2	6.35	32	7	10
3	6.35	32	8	10

108P-50 (PH)	D (mm)	L (mm)	(g)	(pcs.)
1	6.35	50	10	10
2	6.35	50	11	10
3	6.35	50	11	10

108S-25	TxW (mm)	D (mm)	L (mm)	(g)	(pcs.)
3	0.5x3	6.35	25	3	10
4	0.6x4	6.35	25	3	10
4.5	0.6x4.5	6.35	25	4	10
5	0.8x5	6.35	25	5	10
5.5	0.8x5.5	6.35	25	5	10
6	1.0x6	6.35	25	5	10
8	1.2x8	6.35	25	6	10

108S-39	TxW (mm)	D (mm)	L (mm)	(g)	(pcs.)
3	0.5x3	6.35	39	6	10
4	0.6x4	6.35	39	6	10
4.5	0.6x4.5	6.35	39	6	10
5	0.8x5	6.35	39	7	10
5.5	0.8x5.5	6.35	39	8	10
6	1.0x6	6.35	39	9	10
8	1.2x8	6.35	39	12	10

108H-25 (mm)	D (mm)	L (mm)	(g)	(pcs.)
3	6.35	25	4	10
4	6.35	25	5	10
5	6.35	25	5	10
6	6.35	25	6	10
7	6.35	25	7	10
8	6.35	25	8	10
10	6.35	25	11	10

108H-25 (inch)	D (mm)	L (mm)	(g)	(pcs.)
1/8	6.35	25	4	10
9/64	6.35	25	5	10
5/32	6.35	25	5	10
3/16	6.35	25	5	10
7/32	6.35	25	6	10
1/4	6.35	25	7	10

108T-25 (T)	D (mm)	L (mm)	(g)	(pcs.)
T 8	6.35	25	4	10
T10	6.35	25	4	10
T15	6.35	25	4	10
T20	6.35	25	5	10
T25	6.35	25	6	10
T27	6.35	25	6	10
T30	6.35	25	6	10
T40	6.35	25	6	10

108T-25 (TH)	D (mm)	L (mm)	(g)	(pcs.)
T10H	6.35	25	4	10
T15H	6.35	25	4	10
T20H	6.35	25	5	10
T25H	6.35	25	6	10
T27H	6.35	25	6	10
T30H	6.35	25	6	10
T40H	6.35	25	6	10

108A-25	D (mm)	L (mm)	(g)	(pcs.)
1/4B	6.35	25	10	10

	□	D <sub>1</sub> (mm)	D <sub>2</sub> (mm)	L (mm)	(g)	(pcs.)
2137	1/4"	12	12	22.5	13	10
3137	3/8"	13	16.5	30	30	10
4137	1/2"	13	22	38	53	10

For DIN3126 C6.3 Bits  
Für DIN3126 C6.3 Bits  
Pour DIN3126 C6.3 Embouts

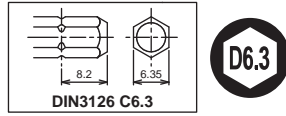

- 2137 ○ Bit Holder  
Klingenhalter  
Porte-embouts
- 3137 ○
- 4137 ○

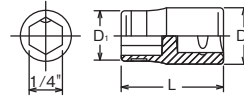

	□	D <sub>1</sub> (mm)	D <sub>2</sub> (mm)	L (mm)	(g)	(pcs.)	⚡
12139	1/4"	11	13	25	15	10	*1
13139	3/8"	11	19	30	32	10	*2
14139	1/2"	11	25	35	62	10	*3

\*1 Pin/O-Ring=1200A/B  
\*2 C-Ring=1301C,Pin/O-Ring=1301A/B  
\*3 C-Ring=1401C,Pin/O-Ring=1401A/B

→ P254-255

For DIN3126 C6.3 Bits  
Für DIN3126 C6.3 Bits  
Pour DIN3126 C6.3 Embouts

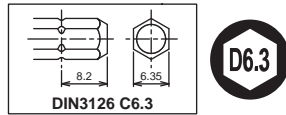

- 12139 ○ Impact Bit Holder  
Impact Klingenhalter  
Porte embouts Impact
- 13139 ○
- 14139 ○

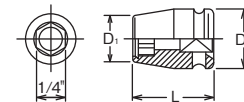

	□	D <sub>1</sub> (mm)	D <sub>2</sub> (mm)	L (mm)	(g)	(pcs.)	⚡
13142-D6.3	3/8"	16	19	45	60	10	*1
14142-D6.3	1/2"	16	25	55	97	10	*2

\*1 C-Ring=1301C,Pin/O-Ring=1301A/B  
\*2 C-Ring=1401C,Pin/O-Ring=1401A/B

→ P254-255

For DIN3126 C6.3 Bits  
Für DIN3126 C6.3 Bits  
Pour DIN3126 C6.3 Embouts

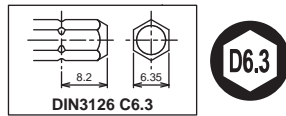

- 13142-D6.3 ○ Impact Bit Holder  
Impact Klingenhalter  
Porte embouts Impact ⚠
- 14142-D6.3 ○

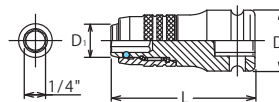

### Lock & Quick Release

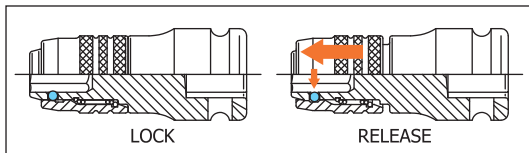

⚠ You may not hold the sliding part while moving to avoid heating up by friction and reduction by wear.

	D (mm)	H (mm)	L (mm)	(g)	(pcs.)
2749P-1/4HF	25	12	125	96	10
2774P-1/4HF	25	12	165	133	2

For DIN3126 C6.3 Bits  
Für DIN3126 C6.3 Bits  
Pour DIN3126 C6.3 Embouts

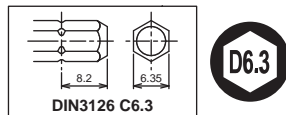

- 2749P-1/4HF ○ Reversible Ratchet, for Bits 1/4"  
Knarre, verstellbar, für Bits 1/4"  
Cliquet, réversible pour embouts 1/4"



- 2774P-1/4HF ○ Flexible Ratchet, reversible, for Bits 1/4"  
Gelenk-Knarre, verstellbar, für Bits 1/4"  
Cliquet à tête articulée pour embouts 1/4"

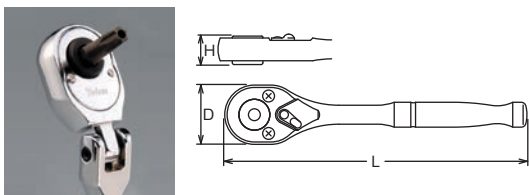
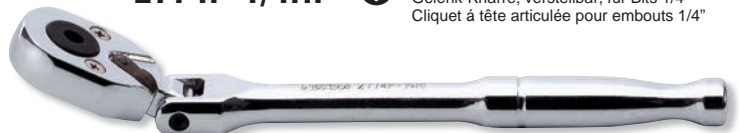

	D (mm)	H (mm)	L (mm)	(g)	(pcs.)
180M-50	11	13.5	50	15	10

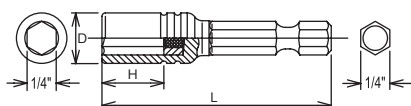

- 180M-50 ○ Bit Holder with Magnet  
Klingenhalter mit Magnet  
Porte-embouts avec aimant



SPARE PART CONSTRUCTION MOTORCYCLE AUTOMOTIVE INDUSTRIAL PROTECTOR SLEEVE-DRIVE IMPACT TITANIUM HAND Z-SERIES

## 100P-32 / -80 / -125 PH Bits PH Bits Embouts, PH

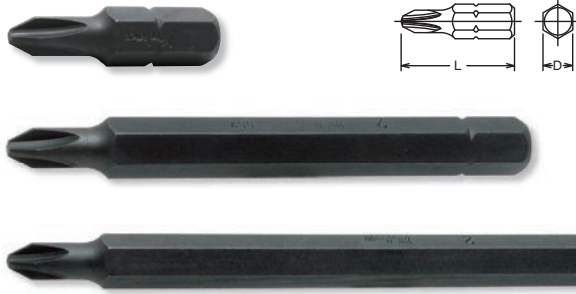

100P-32 (PH)	D (mm)	L (mm)	(g)	(pcs.)
1	8	32	11	10
2	8	32	11	10
3	8	32	12	10
4	8	32	12	10

100P-80 (PH)	D (mm)	L (mm)	(g)	(pcs.)
1	8	80	30	10
2	8	80	30	10
3	8	80	31	10
4	8	80	32	10

100P-125 (PH)	D (mm)	L (mm)	(g)	(pcs.)
2	8	125	48	10
3	8	125	49	10

## 100P-32 (PZ) PZ Bits PZ Bits Embouts, PZ



100P-32 (PZ)	D (mm)	L (mm)	(g)	(pcs.)
PZ2	8	32	10	10
PZ3	8	32	11	10

## 100S-32 / -80 Slotted Bits Schlitz Bits Embouts, fente

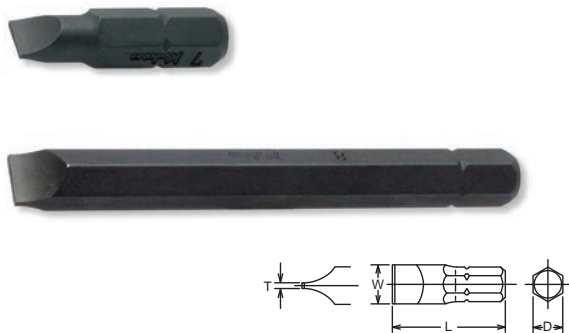

100S-32	TxW (mm)	D (mm)	L (mm)	(g)	(pcs.)
6	1 x 6	8	32	10	10
7	1 x 7	8	32	11	10
8	1.2x 8	8	32	12	10
9	1.6x 9	8	32	12	10
10	1.6x10	8	32	13	10
11	1.6x11	8	32	15	10
12	2 x12	8	32	18	10
14	2 x14	8	32	21	10

100S-80	TxW (mm)	D (mm)	L (mm)	(g)	(pcs.)
6	1 x 6	8	80	29	10
7	1 x 7	8	80	30	10
8	1.2x 8	8	80	31	10
9	1.6x 9	8	80	32	10
10	1.6x10	8	80	33	10
11	1.6x11	8	80	33	10
12	2 x12	8	80	34	10
14	2 x14	8	80	37	10

## 100H-32 Hex Bits Sechskant Bits Embouts, 6 pans creux



100H-32 (mm)	D (mm)	L (mm)	(g)	(pcs.)
3	8	32	11	10
4	8	32	11	10
5	8	32	12	10
6	8	32	12	10
7	8	32	13	10
8	8	32	13	10
9	8	32	16	10
10	8	32	16	10
11	8	32	20	10
12	8	32	23	10
14	8	32	29	10

## 100T-32 (T) TORX® Bits TORX® Bits Embouts, TORX®



100T-32 (T)	D (mm)	L (mm)	(g)	(pcs.)
T10	8	32	9	10
T15	8	32	9	10
T20	8	32	9	10
T25	8	32	10	10
T27	8	32	10	10
T30	8	32	11	10
T40	8	32	12	10
T45	8	32	12	10
T50	8	32	12	10
T55	8	32	12	10



100T-32 (TH)	D (mm)	L (mm)	(g)	(pcs.)
T10H	8	32	9	10
T15H	8	32	9	10
T20H	8	32	9	10
T25H	8	32	10	10
T27H	8	32	10	10
T30H	8	32	11	10
T40H	8	32	12	10
T45H	8	32	12	10
T50H	8	32	12	10
T55H	8	32	12	10

100X-32	D (mm)	L (mm)	(g)	(pcs.)
M 5	8	32	10	10
M 6	8	32	11	10
M 8	8	32	12	10
M10	8	32	16	10
M12	8	32	19	10

		D <sub>1</sub> (mm)	D <sub>2</sub> (mm)	L (mm)	(g)	(pcs.)
2138	1/4"	16	16	26	32	10
3138	3/8"	16	18	38	55	10
4138	1/2"	16	22	38	62	10

For DIN3126 C8 Bits  
Für DIN3126 C8 Bits  
Pour DIN3126 C8 Embouts

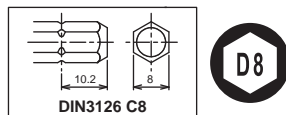

## 100T-32 (TH)

Tamper-Resistant TORX® Bits  
Tamper-Resistant TORX® Bits  
Embouts TORX®, Tamper-Resistant



Tamper Resistant TORX® Bits have less strength due to special design.  
Make sure to use it correctly.

## 100X-32 (XZN)

XZN Bits  
XZN Bits  
Embouts, XZN



## 2138

Bit Holder  
Klingenhalter  
Porte-embouts

## 3138

## 4138

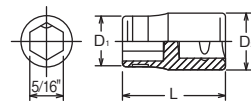

## 12140

## 13140

## 14140

Impact Bit Holder  
Impact Klingenhalter  
Porte embouts Impact

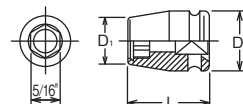

		D <sub>1</sub> (mm)	D <sub>2</sub> (mm)	L (mm)	(g)	(pcs.)	
12140	1/4"	14	13	25	15	10	*1
13140	3/8"	14	19	30	32	10	*2
14140	1/2"	14	25	35	62	10	*3

\*1 Pin/O-Ring=1200A/B  
\*2 C-Ring=1301C, Pin/O-Ring=1301A/B  
\*3 C-Ring=1401C, Pin/O-Ring=1401A/B

For DIN3126 C8 Bits  
Für DIN3126 C8 Bits  
Pour DIN3126 C8 Embouts

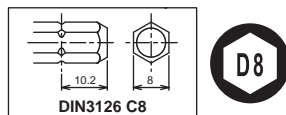

	D (mm)	H (mm)	L (mm)	(g)	(pcs.)
2749P-5/16HF	25	14	125	96	10
2774P-5/16HF	25	14	165	133	2

For DIN3126 C8 Bits  
Für DIN3126 C8 Bits  
Pour DIN3126 C8 Embouts

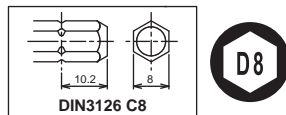

## 2749P-5/16HF

Reversible Ratchet, for Bits 5/16"  
Knarre, verstellbar für Bits 5/16"  
Cliquet, réversible pour embouts 5/16"



## 2774P-5/16HF

Flexible Ratchet, reversible, for Bits 5/16"  
Gelenk-Knarre, verstellbar, für Bits 5/16"  
Cliquet à tête articulée pour embouts 5/16"

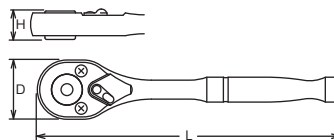

**121P-50 / -70 / -100 / -150**  PH Bits  
PH Bits  
Embouts, PH

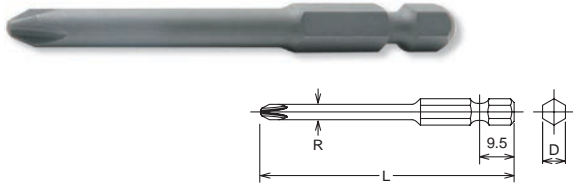

121P-50 (PH)	D (mm)	R (mm)	L (mm)	(g)	(pcs.)
1	6.35	4.5	50	12	10
2	6.35	5.5	50	12	10
3	6.35	-	50	13	10

121P-70 (PH)	D (mm)	R (mm)	L (mm)	(g)	(pcs.)
1	6.35	4.5	70	15	10
2	6.35	5.5	70	15	10
3	6.35	-	70	16	10

121P-100 (PH)	D (mm)	R (mm)	L (mm)	(g)	(pcs.)
1	6.35	4.5	100	23	10
2	6.35	5.5	100	23	10
3	6.35	-	100	24	10

121P-150 (PH)	D (mm)	R (mm)	L (mm)	(g)	(pcs.)
1	6.35	4.5	150	30	10
2	6.35	5.5	150	35	10
3	6.35	-	150	36	10

**121H-50 / -70 / -100 / -150**  Hex Bits  
Sechskant Bits  
Embouts, 6 pans creux

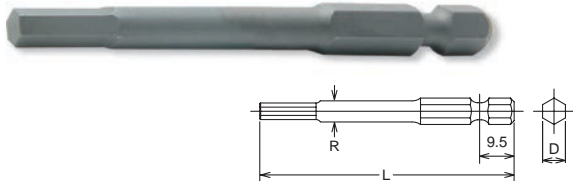

121H-50 (mm)	D (mm)	R (mm)	L (mm)	(g)	(pcs.)
2	6.35	3	50	11	10
2.5	6.35	3	50	12	10
3	6.35	3.5	50	12	10
4	6.35	4.5	50	12	10
5	6.35	5.6	50	13	10
6	6.35	-	50	14	10

121H-70 (mm)	D (mm)	R (mm)	L (mm)	(g)	(pcs.)
2	6.35	3	70	13	10
2.5	6.35	3	70	15	10
3	6.35	3.5	70	15	10
4	6.35	4.5	70	15	10
5	6.35	5.6	70	16	10
6	6.35	-	70	18	10

121H-100 (mm)	D (mm)	R (mm)	L (mm)	(g)	(pcs.)
2	6.35	3	100	22	10
2.5	6.35	3	100	23	10
3	6.35	3.5	100	23	10
4	6.35	4.5	100	23	10
5	6.35	5.6	100	24	10
6	6.35	-	100	26	10

121H-150 (mm)	D (mm)	R (mm)	L (mm)	(g)	(pcs.)
2	6.35	3.5	150	35	10
2.5	6.35	3.5	150	35	10
3	6.35	3.5	150	37	10
4	6.35	4.5	150	37	10
5	6.35	5.6	150	38	10
6	6.35	-	150	39	10

**121T-50 / -70 / -100 / -150 (T)**  TORX® Bits  
TORX® Bits  
Embouts, TORX®

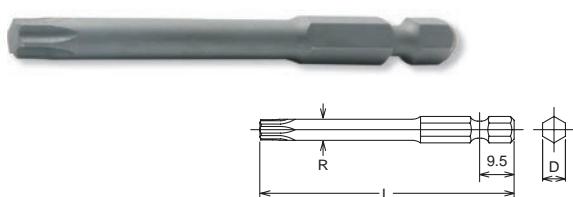

121T-50 (T)	D (mm)	R (mm)	L (mm)	(g)	(pcs.)
T10	6.35	3	50	12	10
T15	6.35	3.5	50	12	10
T20	6.35	4.1	50	12	10
T25	6.35	4.6	50	12	10
T27	6.35	5.2	50	13	10
T30	6.35	5.7	50	13	10
T40	6.35	-	50	14	10

121T-70 (T)	D (mm)	R (mm)	L (mm)	(g)	(pcs.)
T10	6.35	3.5	70	16	10
T15	6.35	3.5	70	16	10
T20	6.35	4.1	70	16	10
T25	6.35	4.6	70	16	10
T27	6.35	5.2	70	17	10
T30	6.35	5.7	70	17	10
T40	6.35	-	70	18	10

121T-100 (T)	D (mm)	R (mm)	L (mm)	(g)	(pcs.)
T10	6.35	3.5	100	24	10
T15	6.35	3.5	100	24	10
T20	6.35	4.1	100	24	10
T25	6.35	4.6	100	24	10
T27	6.35	5.2	100	24	10
T30	6.35	5.7	100	25	10
T40	6.35	-	100	26	10

121T-150 (T)	D (mm)	R (mm)	L (mm)	(g)	(pcs.)
T10	6.35	3.5	150	35	10
T15	6.35	3.5	150	37	10
T20	6.35	4.1	150	37	10
T25	6.35	4.6	150	37	10
T27	6.35	5.2	150	37	10
T30	6.35	5.7	150	38	10
T40	6.35	-	150	39	10

121T-70 (TH)	D (mm)	R (mm)	L (mm)	(g)	(pcs.)
T15H	6.35	3.5	70	15	10
T20H	6.35	4.1	70	16	10
T25H	6.35	4.6	70	16	10
T27H	6.35	5.2	70	17	10
T30H	6.35	5.7	70	17	10
T40H	6.35	-	70	18	10

121T-100 (TH)	D (mm)	R (mm)	L (mm)	(g)	(pcs.)
T15H	6.35	3.5	100	22	10
T20H	6.35	4.1	100	24	10
T25H	6.35	4.6	100	24	10
T27H	6.35	5.2	100	24	10
T30H	6.35	5.7	100	25	10
T40H	6.35	-	100	26	10

**⚠** Tamper Resistant TORX® Bits have less strength due to special design. Make sure to use it correctly.

121T-50 (IP)	D (mm)	R (mm)	L (mm)	(g)	(pcs.)
20IP	6.35	4.1	50	12	10
25IP	6.35	4.6	50	12	10
27IP	6.35	5.2	50	13	10
30IP	6.35	5.7	50	13	10
40IP	6.35	-	50	14	10

121T-70 (IP)	D (mm)	R (mm)	L (mm)	(g)	(pcs.)
20IP	6.35	4.1	70	16	10
25IP	6.35	4.6	70	16	10
27IP	6.35	5.2	70	17	10
30IP	6.35	5.7	70	17	10
40IP	6.35	-	70	18	10

	□	D <sub>1</sub> (mm)	D <sub>2</sub> (mm)	L (mm)	(g)	(pcs.)	⚡
12137E	1/4"	12	13	36	22	10	*1
13137E	3/8"	12	19	40	40	10	*2
14137E	1/2"	12	25	48	70	10	*3

\*1 Pin/O-Ring=1200A/B  
 \*2 C-Ring=1301C, Pin/O-Ring=1301A/B  
 \*3 C-Ring=1401C, Pin/O-Ring=1401A/B

→ P254-255

For DIN3126 E6.3 Bits  
 Für DIN3126 E6.3 Bits  
 Pour DIN3126 E6.3 Embouts

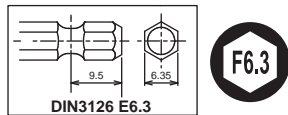

12137E, 13137E and 14147E can be used with various 1/4" bits, DIN 3126-C6.3, DIN 3126-E6.3 and Double ended type.

Die neuen Bithalter können für alle 1/4" Bits DIN 3126-C6.3, DIN 3126-E6.3 und für doppelseitige Bits verwendet werden.

Ces nouveaux porte embouts peuvent être utilisés avec tous les embouts 1/4" DIN 3126 E-6.3 et DIN 3126 C6.3

	□	D <sub>1</sub> (mm)	D <sub>2</sub> (mm)	L (mm)	(g)	(pcs.)	⚡
12142-F6.3	1/4"	16.5	13	40	22	10	*1
13142-F6.3	3/8"	16.5	19	45	60	10	*2
14142-F6.3	1/2"	16.5	25	55	100	10	*3

\*1 Pin/O-Ring=1200A/B  
 \*2 C-Ring=1301C, Pin/O-Ring=1301A/B  
 \*3 C-Ring=1401C, Pin/O-Ring=1401A/B

→ P254-255

For DIN3126 E6.3 Bits  
 Für DIN3126 E6.3 Bits  
 Pour DIN3126 E6.3 Embouts

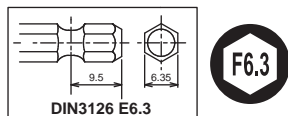

**Lock & Quick Release**

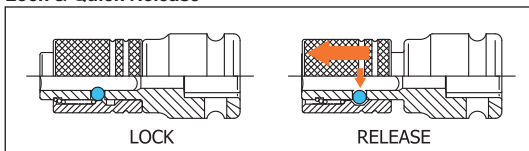

**⚠** You may not hold the sliding part while moving to avoid heating up by friction and reduction by wear.

TORXplus is a registered trademark of Acument Intellectual Properties, LLC.  
 TORXplus ist ein registriertes Markenzeichen der Firma Acument Intellectual Properties, LLC.  
 TORXplus est une marque déposée de Acument Intellectual Properties, LLC.

## 121T-70 / -100 (TH)

**⚠** Tamper-Resistant TORX® Bits  
 Tamper-Resistant TORX® Bits  
 Embouts TORX®, Tamper-Resistant

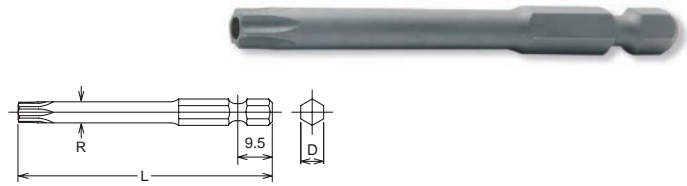

## 121T-50 / -70 (IP)

**⚠** TORXPLUS® Bits  
 TORXPLUS® Bits  
 Embouts TORXPLUS®

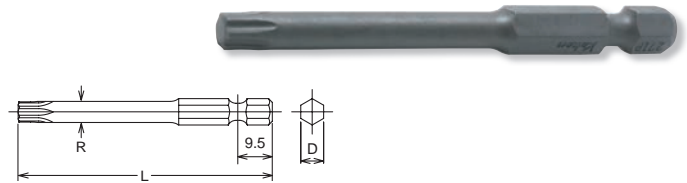

## 12137E 13137E 14137E

**⚠** Impact Bit Holder  
 Impact Klingenhalter  
 Porte embouts Impact



## 12142-F6.3 13142-F6.3 14142-F6.3

**⚠** Impact Bit Holder (Quick Release)  
 Impact Klingenhalter (Quick Release)  
 Porte embouts Impact (Quick Release)



### 123PT-75 / -100

⊕ Double ended Torsion Bits, Phillips  
Doppelseitige Torsionsbits, Phillips  
Emboutis torsion double face, Phillips

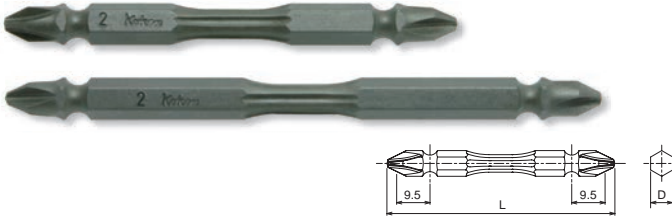

123PT (PH)	D (mm)	L (mm)	(g)	(pcs.)
2	6.35	75	18	10
2	6.35	100	24	10

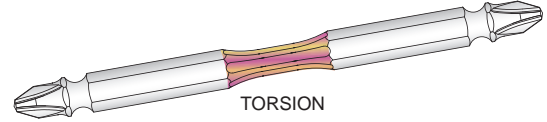

### 123PN-75 / -100

⊕ Double ended Bits, Phillips  
Doppelseitige bits, Phillips  
Emboutis double face, Phillips

### 123PG-75 / -100

⊕ Magnetic type  
Magnetisch  
Type magnétique

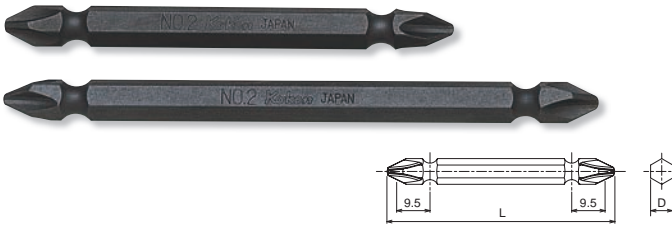

123PN.75 123PG.75 (PH)	D (mm)	L (mm)	(g)	(pcs.)
1	6.35	75	16	10
2	6.35	75	16	10
3	6.35	75	17	10

123PN.100 123PG.100 (PH)	D (mm)	L (mm)	(g)	(pcs.)
1	6.35	100	23	10
2	6.35	100	23	10
3	6.35	100	24	10

### 165LM

○ Slide Socket with Magnet  
Gleitsteckschlüssel mit Magnet  
Clé à douille coulissante avec aimant

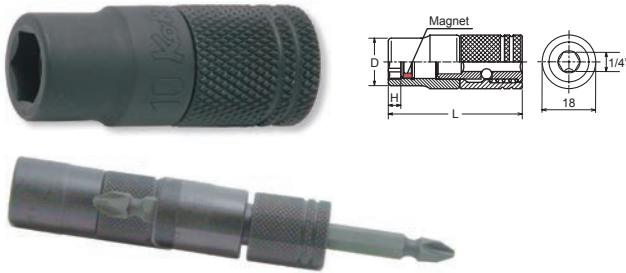

165LM.45 (mm)	D (mm)	H (mm)	L (mm)	(g)	(pcs.)
8	13.5	3.5	45	55	10
10	16	4.2	45	58	10
12	18.5	5.6	45	65	10
13	20	6	45	68	10
14	21	6.4	45	70	10

Slide the socket by pulling holder, and pull back the socket to lock on the bit groove. Ring magnet holds a bolt or nut for easy work.

Schieben Sie den Gleitsteckschlüssel durch Ziehen an der Hülse des Halters. Ziehen Sie das Werkzeug soweit zurück bis es sich in der Nut des Bits verriegelt. Zur Arbeitserleichterung hält der Ringmagnet die Schraube bzw. die Mutter.

Poussez la clé à douille coulissante en tirant sur le support. Tirez l'outil vers l'arrière jusqu'à ce qu'il s'enclenche dans la rainure de la meche. L'aimant maintient la vis ou l'ecrou pour faciliter le travail.

⚠ You may not hold the sliding part while moving to avoid heating up by friction and reduction by wear.

Sie dürfen das Gleiteil nicht während der Bewegung halten, um Erwärmung durch Reibung und unnötigen Verschleiss zu vermeiden.

Ne pas tenir la partie coulissante pendant le mouvement pour éviter l'échauffement du au frottement et à l'usure inutile.

⚠ Please handle with care. The magnet could be broken with any impacts.

Der Magnet kann durch Stöße beschädigt werden. Bitte gehen Sie vorsichtig vor. L'aimant peut être endommagé par des chocs importants. Veuillez procéder avec précaution.

#### Nut Setter

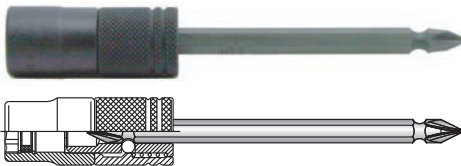

#### Phillips Bit

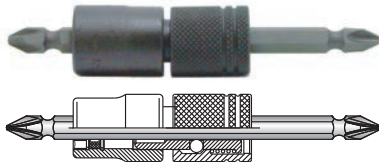

### 165BM

○ Double-sided sliding socket wrench with side magnets  
Doppelseitiger Schiebsteckschlüssel mit Seitenmagneten  
Clé à douille double face, coulissante avec aimants latéraux



165BM.70 (mm)	D <sub>1</sub> (mm)	D <sub>2</sub> (mm)	H <sub>1</sub> (mm)	H <sub>2</sub> (mm)	L (mm)	(g)	(pcs.)
<b>New</b> 8x10	13	16	5	6	70	55	10

165BM.80 (mm)	D <sub>1</sub> (mm)	D <sub>2</sub> (mm)	H <sub>1</sub> (mm)	H <sub>2</sub> (mm)	L (mm)	(g)	(pcs.)
<b>New</b> 10x12	16	19.1	6	8	80	80	10

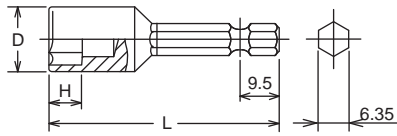

113-50 (mm)	D (mm)	H (mm)	L (mm)	(g)	(pcs.)
5.5	9	4	50	15	10
6	10	5	50	17	10
7	11	5	50	19	10
8	12	6	50	20	10
10	14.2	7	50	31	10
12	17	8	50	39	10
13	18	8	50	42	10
14	19	9	50	46	10

## 113-50

Nut Setters  
Steckschlüssel Klingen  
Embouts pour écrous



113-50 (inch)	D (mm)	H (mm)	L (mm)	(g)	(pcs.)
1/4	10	5	50	17	10
5/16	12	6	50	20	10
3/8	14.2	7	50	31	10
1/2	18	8	50	42	10

## 113-75 / -100 / -150 / -200 / -250

Nut Setters  
Steckschlüssel Klingen  
Embouts pour écrous

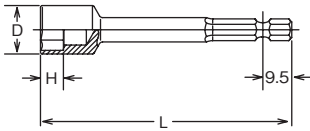

113-75 (mm)	D (mm)	H (mm)	L (mm)	(g)	(pcs.)
7	11.5	5	75	31	10
8	12.7	6	75	32	10
10	14.5	7	75	35	10
12	17	8	75	42	10
13	18	8	75	41	10
14	19	9	75	43	10

113-100 (mm)	D (mm)	H (mm)	L (mm)	(g)	(pcs.)
7	11.5	5	100	40	10
8	12.7	6	100	41	10
10	14.5	7	100	45	10
12	17	8	100	52	10
13	18	8	100	51	10
14	19	9	100	53	10

113-150 (mm)	D (mm)	H (mm)	L (mm)	(g)	(pcs.)
7	11.5	5	150	59	10
8	12.7	6	150	60	10
10	14.5	7	150	64	10
12	17	8	150	70	10
13	18	8	150	76	10
14	19	9	150	78	10

113-200 (mm)	D (mm)	H (mm)	L (mm)	(g)	(pcs.)
7	11.5	5	200	78	10
8	12.7	6	200	79	10
10	14.5	7	200	83	10
12	17	8	200	91	10
13	18	8	200	93	10
14	19	9	200	95	10

113-250 (mm)	D (mm)	H (mm)	L (mm)	(g)	(pcs.)
7	11.5	5	250	99	10
8	12.7	6	250	100	10
10	14.5	7	250	105	10
12	17	8	250	113	10
13	18	8	250	114	10
14	19	9	250	119	10

113-50 (E)	D (mm)	H (mm)	L (mm)	(g)	(pcs.)
E 4	6.1	4.5	50	12	10
E 5	7.5	4.5	50	15	10
E 6	8.3	5.0	50	17	10
E 7	8.8	5.8	50	18	10
E 8	10.1	6.6	50	19	10
E10	12	7.4	50	20	10

## 113-50 (E)

Nut Setters, TORX®  
Steckschlüssel Klingen, TORX®  
Embouts pour écrous, TORX®

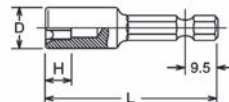

113-50 (mm)	D (mm)	H (mm)	L (mm)	(g)	(pcs.)
7(2B)	11	5	50	20	10
8(2B)	12	6	50	21	10
10(2B)	14.2	7	50	26	10
13(2B)	18	8	50	31	10



## 113-50 (2B)

Nut Setters, with 2 Balls  
Steckschlüssel Klingen, mit 2-facher Kugelhalterung  
Douilles à billes de retenue  
Nut Grip®

113-50 (inch)	D (mm)	H (mm)	L (mm)	(g)	(pcs.)
3/8(2B)	14.2	7	50	26	10

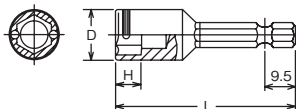

Z-SERIES  
HAND  
TITANIUM  
ACCESSORIES  
SCREWDRIVERS  
IMPACT  
SLEEVE-DRIVE  
PROTECTOR  
INDUSTRIAL  
AUTOMOTIVE  
MOTORCYCLE  
CONSTRUCTION  
SPARE PART

**115-50**  Nut Setters with Magnet  
Steckschlüssel Klingen mit Magnet  
Embouts avec aimant pour écrous

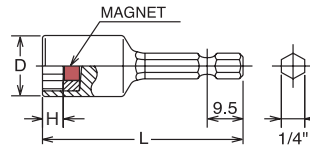

115-50 (mm)	D (mm)	H (mm)	L (mm)	(g)	(pcs.)
5.5	9	2.1	50	15	10
6	10	2.4	50	17	10
7	11	2.8	50	19	10
8	12	3.5	50	20	10
10	14.2	4.2	50	29	10
12	17	5.6	50	40	10
13	18	6	50	50	10
14	19	6.4	50	60	10

115-50 (inch)	D (mm)	H (mm)	L (mm)	(g)	(pcs.)
1/4	10	2.4	50	17	10
5/16	12	3.5	50	20	10
3/8	14.2	4.2	50	29	10
1/2	18	6	50	50	10

**115-75 / -100 / -150 / -200 / -250**

 Nut Setters with Magnet  
Steckschlüssel Klingen mit Magnet  
Embouts avec aimant pour écrous

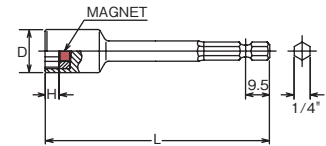

115-75 (mm)	D (mm)	H (mm)	L (mm)	(g)	(pcs.)
7	11.5	2.8	75	32	10
8	12.7	3.5	75	33	10
10	14.5	4.2	75	38	10
12	17	5.6	75	46	10
13	18	6	75	49	10
14	19	6.4	75	52	10

115-100 (mm)	D (mm)	H (mm)	L (mm)	(g)	(pcs.)
7	11.5	2.8	100	41	10
8	12.7	3.5	100	42	10
10	14.5	4.2	100	50	10
12	17	5.6	100	58	10
13	18	6	100	62	10
14	19	6.4	100	65	10

115-150 (mm)	D (mm)	H (mm)	L (mm)	(g)	(pcs.)
7	11.5	2.8	150	60	10
8	12.7	3.5	150	61	10
10	14.5	4.2	150	68	10
12	17	5.6	150	77	10
13	18	6	150	82	10
14	19	6.4	150	85	10

115-200 (mm)	D (mm)	H (mm)	L (mm)	(g)	(pcs.)
7	11.5	2.8	200	79	10
8	12.7	3.5	200	80	10
10	14.5	4.2	200	88	10
12	17	5.6	200	97	10
13	18	6	200	102	10
14	19	6.4	200	105	10

115-250 (mm)	D (mm)	H (mm)	L (mm)	(g)	(pcs.)
7	11.5	2.8	250	101	10
8	12.7	3.5	250	103	10
10	14.5	4.2	250	110	10
12	17	5.6	250	118	10
13	18	6	250	122	10
14	19	6.4	250	124	10



## 113UN-100 / -150 / -200

6-point Universal Joint Nut Setters  
6-kant Steckschlüsselklingen mit Gelenk  
Douilles 6-pans articulées à embout



113UN-100 (mm)	D (mm)	H (mm)	L (mm)	(g)	(pcs.)
8	13	7	100	50	10
10	15	8	100	53	10
12	17	10	100	56	10
13	18	10	100	65	10
14	19.2	10	100	67	10

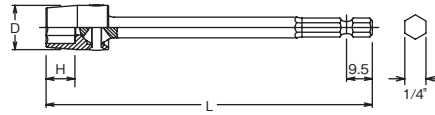

113UN-150 (mm)	D (mm)	H (mm)	L (mm)	(g)	(pcs.)
8	13	7	150	65	10
10	15	8	150	70	10
12	17	10	150	77	10
13	18	10	150	92	10
14	19.2	10	150	92	10

113UN-200 (mm)	D (mm)	H (mm)	L (mm)	(g)	(pcs.)
8	13	7	200	75	10
10	15	8	200	87	10
12	17	10	200	98	10
13	18	10	200	116	10
14	19.2	10	200	116	10

## 115G-75 / -100 / -150 / -200 / -250

Nut Setters with sliding Magnet  
Steckschlüssel Klingen mit versenkbarem Magnet  
Embouts avec aimant, glissant pour écrous



115G-75 (mm)	D (mm)	H <sub>1</sub> (mm)	H <sub>2</sub> (mm)	L (mm)	(g)	(pcs.)
7	11.5	3.5	26	75	34	10
8	12.7	4	26	75	41	10
10	14.5	4.5	26	75	48	10
12	17	6	26	75	65	10
13	18	6.5	25	75	70	10
14	19	7	24	75	73	10

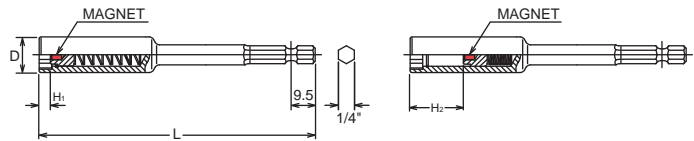

115G-150 (mm)	D (mm)	H <sub>1</sub> (mm)	H <sub>2</sub> (mm)	L (mm)	(g)	(pcs.)
7	11.5	3.5	26	150	67	10
8	12.7	4	26	150	70	10
10	14.5	4.5	26	150	77	10
12	17	6	26	150	95	10
13	18	6.5	25	150	100	10
14	19	7	24	150	105	10

115G-100 (mm)	D (mm)	H <sub>1</sub> (mm)	H <sub>2</sub> (mm)	L (mm)	(g)	(pcs.)
7	11.5	3.5	26	100	51	10
8	12.7	4	26	100	51	10
10	14.5	4.5	26	100	57	10
12	17	6	26	100	77	10
13	18	6.5	25	100	80	10
14	19	7	24	100	82	10

115G-250 (mm)	D (mm)	H <sub>1</sub> (mm)	H <sub>2</sub> (mm)	L (mm)	(g)	(pcs.)
8	12.7	4	26	250	110	10
10	14.5	4.5	26	250	120	10
12	17	6	26	250	130	10
13	18	6.5	25	250	150	10

115G-200 (mm)	D (mm)	H <sub>1</sub> (mm)	H <sub>2</sub> (mm)	L (mm)	(g)	(pcs.)
7	11.5	3.5	26	200	86	10
8	12.7	4	26	200	89	10
10	14.5	4.5	26	200	96	10
12	17	6	26	200	119	10
13	18	6.5	25	200	125	10
14	19	7	24	200	128	10

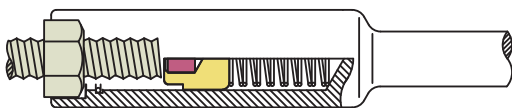

Sliding magnet system provides bolt clearance and magnetic function at the same time. The item 115G is mainly designed for assembly line work.

Die Steckschlüsselklinge mit versenkbarem Magnet bietet die Funktion eines Haltemagneten und genügend Freiraum für überstehende Bolzen. Dieses Werkzeug eignet sich vor allem für Montagearbeiten.

L'embout avec aimant glissant offre une fonction d'aimant et laisse assez d'espace pour des goujons surmontés. L'objet 115G a été conçu spécialement pour le travail d'assemblage.

119 (mm)	D (mm)	H (mm)	L (mm)	(g)	(pcs.)
5.5	9	2.1	50	17	10
6	10	2.4	50	20	10
7	11	2.8	50	22	10
8	12	3.5	50	23	10
10	14.2	4.2	50	30	10
12	17	5.6	50	42	10
13	18	6	50	52	10

119 Nut Setters with Magnet  
Steckschlüssel Klingen mit Magnet  
Embouts avec aimant pour écrous

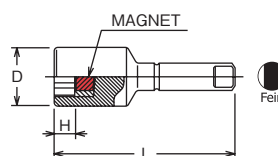

119 (inch)	D (mm)	H (mm)	L (mm)	(g)	(pcs.)
1/4	10	1.8	50	20	10
5/16	12	3.5	50	23	10
3/8	14.2	4.2	50	30	10

Z-SERIES  
HAND  
TITANIUM  
SCREWDRIVERS ACCESSORIES  
IMPACT  
SLEEVE-DRIVE  
PROTECTOR  
INDUSTRIAL  
AUTOMOTIVE  
MOTORCYCLE  
CONSTRUCTION  
SPARE PART

## 183H-35 / -75 / -150

Hex Bits  
Sechskant Bits  
Embout, 6 pans creux

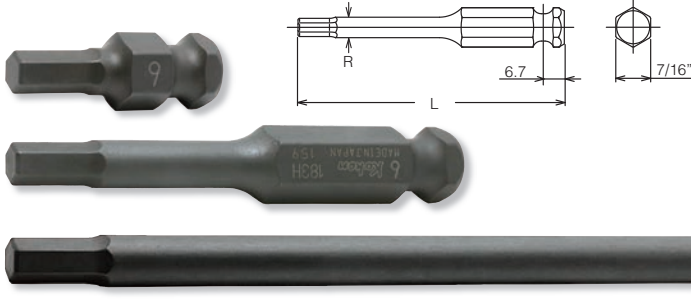

183H-35 (inch)	L (mm)	(g)	(pcs.)
3/16	35	15	10
7/32	35	16	10
1/4	35	18	10
5/16	35	20	10
3/8	35	26	10
7/16	35	28	10
1/2	35	38	10

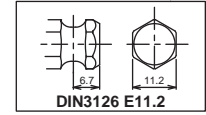

183H-35 (mm)	L (mm)	(g)	(pcs.)
3	35	15	10
4	35	15	10
5	35	15	10
6	35	18	10
7	35	19	10
8	35	20	10
New 9	35	23	10
10	35	26	10
11	35	28	10
12	35	30	10
14	35	35	10
16	35	47	10
17	35	50	10
18	35	53	10
19	35	56	10

183H-75 (mm)	L (mm)	R (mm)	(g)	(pcs.)
3	75	6	34	10
4	75	6	35	10
5	75	6.5	36	10
6	75	7.5	39	10
7	75	8.5	44	10
8	75	9.5	47	10
10	75	-	57	10
11	75	-	60	10
12	75	-	65	10
14	75	-	79	10

183H-150 (mm)	L (mm)	R (mm)	(g)	(pcs.)
4	150	6	51	10
5	150	6.5	55	10
6	150	7.5	65	10
8	150	9.5	87	10
10	150	-	118	10
12	150	-	136	10

## 183T-35 / -75 / -150 (T)

TORX® Bits  
TORX® Bits  
Embout, TORX®

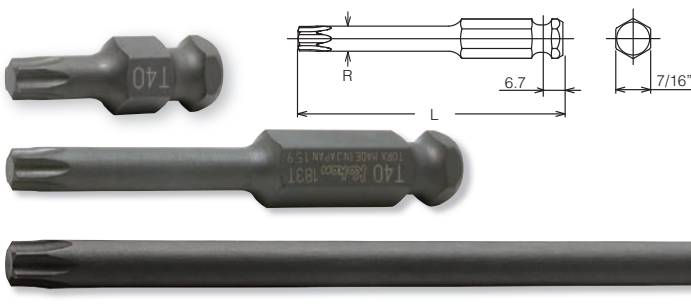

183T-35 (T)	L (mm)	(g)	(pcs.)
T25	35	18	10
T30	35	18	10
T40	35	20	10
T45	35	22	10
T50	35	26	10
T55	35	30	10
T60	35	38	10

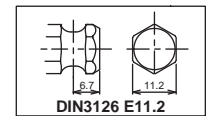

183T-75 (T)	L (mm)	R (mm)	(g)	(pcs.)
T30	75	6	35	10
T40	75	6.9	37	10
T45	75	8	41	10
T50	75	9	45	10
T55	75	11.4	55	10
T60	75	13.5	67	10

183T-150 (T)	L (mm)	R (mm)	(g)	(pcs.)
T30	150	6	50	10
T40	150	6.9	58	10
T45	150	8	70	10
T50	150	9	82	10
T55	150	11.4	113	10

## 183T-35 / -75 (IP)

TORXPLUS® Bits  
TORXPLUS® Bits  
Embout TORXPLUS®

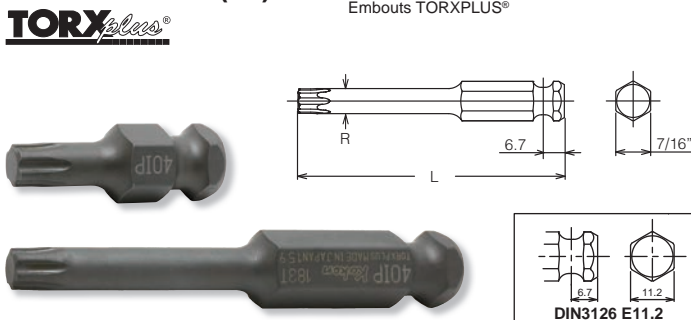

183T-35 (IP)	L (mm)	(g)	(pcs.)
30IP	35	18	10
40IP	35	20	10
45IP	35	22	10
50IP	35	26	10
55IP	35	30	10
60IP	35	38	10

183T-75 (IP)	L (mm)	R (mm)	(g)	(pcs.)
30IP	75	6	35	10
40IP	75	6.8	37	10
45IP	75	8	41	10
50IP	75	9	45	10
55IP	75	11.4	56	10
60IP	75	13.5	67	10



## 183X-35 / -75 / -150 (XZN)

XZN Bits  
XZN Bits  
Embouts, XZN

183X-35 (XZN)	L (mm)	(g)	(pcs.)
M 4	35	18	10
M 5	35	18	10
M 6	35	20	10
M 8	35	22	10
M10	35	26	10
M12	35	30	10
M14	35	38	10

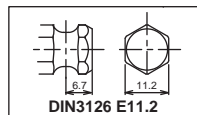
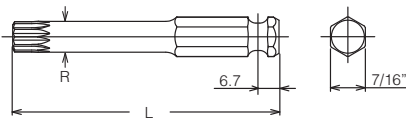

183X-75 (XZN)	L (mm)	R (mm)	(g)	(pcs.)
M 4	75	6	34	10
M 5	75	6	34	10
M 6	75	6.2	36	10
M 8	75	7.4	39	10
M10	75	9.8	54	10
M12	75	11.7	57	10
M14	75	13.5	67	10

183X-150 (XZN)	L (mm)	R (mm)	(g)	(pcs.)
M 5	150	6	50	10
M 6	150	6.2	53	10
M 8	150	7.4	64	10
M10	150	9.8	93	10
M12	150	11.7	121	10

		D (mm)	L (mm)	(g)	(pcs.)	
13134	3/8"	22	32	70	10	*1
14134	1/2"	25	38	90	10	*2
16134	3/4"	44	52	200	2	*3

\*1 C-Ring=1302C, Pin/O-Ring=1302A/B  
\*2 C-Ring=1401C, Pin/O-Ring=1401A/B  
\*3 C-Ring=1600C, Pin/O-Ring=1601A/B

→ P254-255

For DIN3126 E11.2 Bits  
Für DIN3126 E11.2 Bits  
Pour DIN3126 E11.2 Embouts

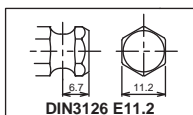

### 13134-SC

Replacement Screw : M8x5, ● 4mm  
Ersatzschraube : M8x5, ● 4mm  
Vis de remplacement : M8x5, ● 4mm

		D <sub>1</sub> (mm)	D <sub>2</sub> (mm)	L (mm)	(g)	(pcs.)	
13142-F11.2	3/8"	18.9	22	46	116	10	*1
14142-F11.2	1/2"	18.9	25	46	207	10	*2

\*1 C-Ring=1302C, Pin/O-Ring=1302A/B  
\*2 C-Ring=1401C, Pin/O-Ring=1401A/B

→ P254-255

For DIN3126 E11.2 Bits  
Für DIN3126 E11.2 Bits  
Pour DIN3126 E11.2 Embouts

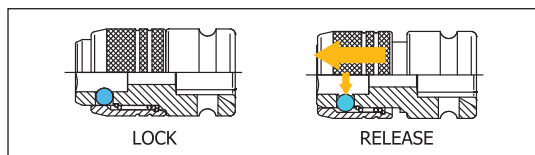
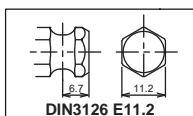

## 13134 14134 16134

Impact Bit Holder  
Impact Klingenhalter  
Porte embouts Impact

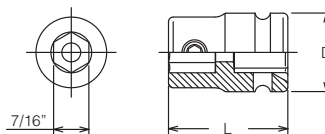

## 13142-F11.2 14142-F11.2

Impact Bit Holder (Quick Release)  
Impact Klingenhalter (Quick Release)  
Porte embouts Impact (Quick Release)

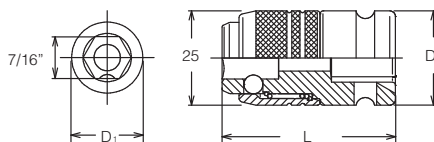

Adaptors with male Square  
 Verbindungsteile mit Aussenvierkant  
 Adaptateurs avec carré mâle

Z-SERIES  
 HAND  
 TITANIUM  
 ACCESSORIES  
 SCREWDRIVERS  
 IMPACT  
 SLEEVE-DRIVE  
 PROTECTOR  
 INDUSTRIAL  
 AUTOMOTIVE  
 MOTORCYCLE  
 CONSTRUCTION  
 SPARE PART

**110-35B / -50B / -100B / -150B  
 -35P / -50P / -100P / -150P**

Adaptors  
 Verbindungsstücke  
 Adaptateurs

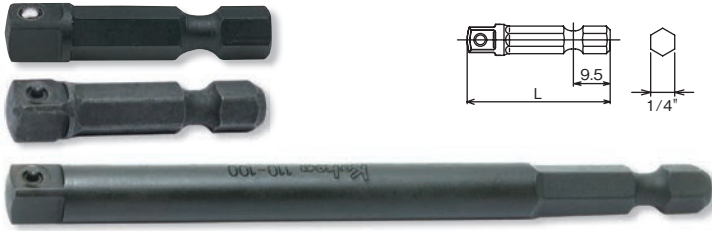

110		TYPE	L (mm)	(g)	(pcs.)
35B	1/4"	Ball	35	9	10
35P		Pin	35	9	10
50B		Ball	50	15	10
50P		Pin	50	15	10
100B		Ball	100	34	10
100P		Pin	100	34	10
150B	Ball	150	54	10	
150P	Pin	150	54	10	

● DIN 3126 Form E 6.3

**112-50B / -100B / -150B  
 -50P / -100P / -150P**

Adaptors  
 Verbindungsstücke  
 Adaptateurs

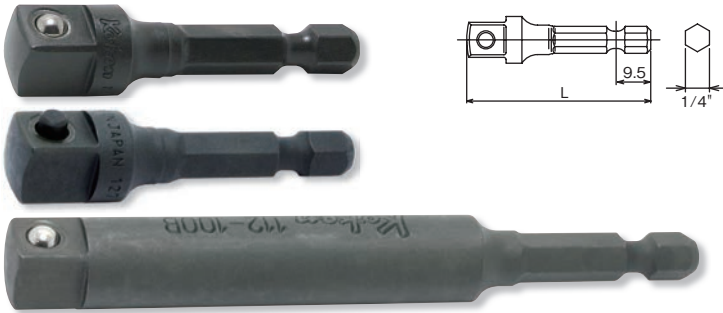

112		TYPE	L (mm)	(g)	(pcs.)
50B	3/8"	Ball	50	22	10
50P		Pin	50	22	10
100B		Ball	100	71	10
100P		Pin	100	71	10
150B		Ball	150	121	10
150P		Pin	150	121	10

● DIN 3126 Form E 6.3

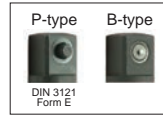

**135E-60B / -60P**

Adaptor  
 Verbindungsstück  
 Adaptateurs

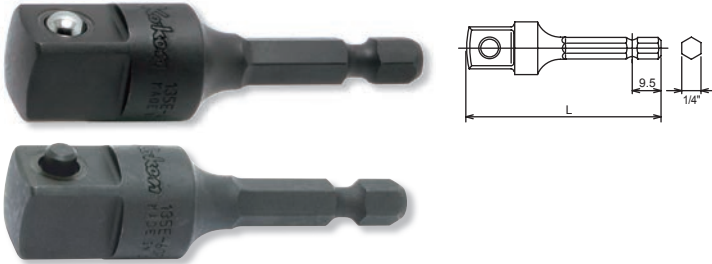

135E		TYPE	L (mm)	(g)	(pcs.)
60B	1/2"	Ball	60	46	10
60P		Pin	60	46	10

● DIN 3126 Form E 6.3

**117-50B / -100B  
 -50P / -100P**

Adaptors  
 Verbindungsstücke  
 Adaptateurs



117		TYPE	L (mm)	(g)	(pcs.)
50B	1/4"	Ball	50	15	10
50P		Pin	50	15	10
100B		Ball	100	71	10
100P		Pin	100	71	10

● DIN 3126 Form G7

**120-50B / -50P**

Adaptor  
 Verbindungsstück  
 Adaptateurs

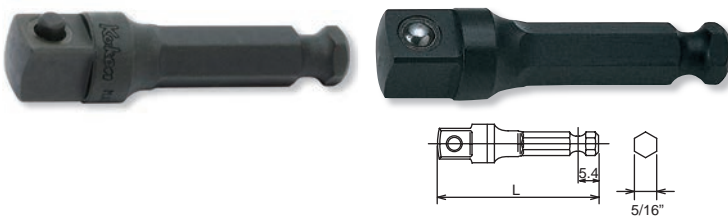

120		TYPE	L (mm)	(g)	(pcs.)
50B	3/8"	Ball	50	27	10
50P		Pin	50	27	10

● DIN 3126 Form E 8

**186-75P**

Adaptor  
 Verbindungsstück  
 Adaptateurs

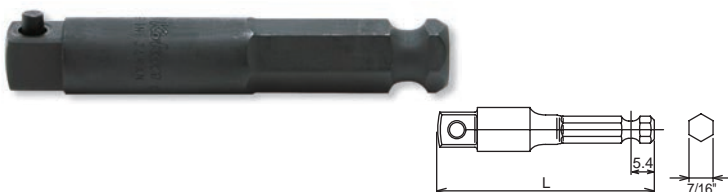

186		L (mm)	(g)	(pcs.)
75P	3/8"	75	65	10
75P	1/2"	75	85	10

● DIN 3126 Form E 11.2

**SCREWDRIVERS  
SCHRAUBENDREHER  
TOURNEVIS**



Z-SERIES  
HAND  
TITANIUM  
ACCESSORIES  
SCREWDRIVERS  
IMPACT  
SLEEVE-DRIVE  
PROTECTOR  
INDUSTRIAL  
AUTOMOTIVE  
MOTORCYCLE  
CONSTRUCTION  
SPARE PART

**167M / 167A**  Socket Drivers  
Sechskant Steckschlüssel, mit Griff  
Clé à douille avec manche

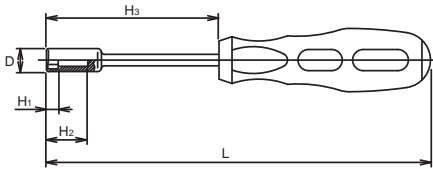



167M (mm)	D (mm)	H <sub>1</sub> (mm)	H <sub>2</sub> (mm)	H <sub>3</sub> (mm)	L (mm)	 (g)	 (pcs.)
3	5.8	3	25	125	225	62	6
3.5	5.8	3	25	125	225	62	6
4	6.7	3.5	25	125	225	64	6
4.5	7.2	4.5	25	125	225	65	6
5	7.8	5	25	125	225	66	6
5.5	8.4	5.5	25	125	225	68	6
6	9.1	6	25	125	225	70	6
7	10.9	6.5	25	125	235	101	6
8	12	7	25	125	235	103	6
9	13.2	7.5	25	125	235	107	6
10	14.5	8	25	125	235	111	6
11	15.9	8.5	25	125	245	155	6
12	16.8	9	25	125	245	161	6
13	18.2	9.5	25	125	245	167	6
14	19.2	11	25	125	245	178	6

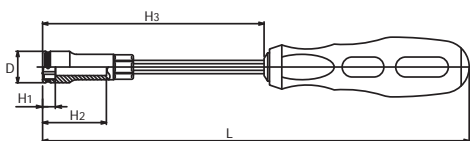

167A (inch)	D (mm)	H <sub>1</sub> (mm)	H <sub>2</sub> (mm)	H <sub>3</sub> (mm)	L (mm)	 (g)	 (pcs.)
1/4	9.1	6	25	125	225	70	6

**167C (2B)**  Interchangeable Socket Driver, **Nut Grip®**  
Universalgriff mit auswechselbaren **Nut Grip®** Steckschlüsselklingen  
Clé à douille interchangeable avec manche **NUT Nut Grip®**

**167C/3-2B**  Set 3 pieces  
Satz 3teilig  
Jeu de 3 tournevis



167C(2B) (mm)	D (mm)	H <sub>1</sub> (mm)	H <sub>2</sub> (mm)	H <sub>3</sub> (mm)	L (mm)	 (g)	 (pcs.)
7(2B)	11.5	4	38	122	235	120	6
8(2B)	12.3	5	38	122	235	125	6
10(2B)	14.2	6	38	122	235	130	6
12(2B)	17.3	7	38	122	235	135	6

<b>167C/3-2B</b>	4 Pieces Set/  =280g
PLASTIC BAG	
Socket Drivers	
 Socket:	7, 8, 10
 Grip:	167C-GRIP

### 168H-B



Ball Point Hex Screwdrivers  
Schraubendreher Innensechskant mit Kugelkopf  
Tournevis avec tête sphérique pour vis 6-pans creux

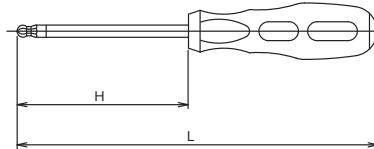

168H (mm)	H (mm)	L (mm)	(g)	(pcs.)
3B	80	150	25	6
4B	125	225	60	6
5B	125	235	85	6
6B	125	245	150	6
7B	125	245	151	6
8B	125	245	153	6

⚠ Ball point Hex Screwdrivers have less strength due to the special design. Make sure to use them correctly.

### 168T (TH)



Screwdriver for TORX® Tamper Resistant  
TORX® Schraubendreher Tamper-Resistant  
Tournevis pour vis TORX® tamper resistant

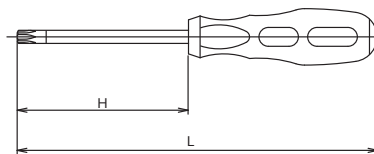

168T (TH)	H (mm)	L (mm)	(g)	(pcs.)
T10H	80	150	25	6
T15H	80	150	25	6
T20H	125	225	60	6
T25H	125	225	60	6
T27H	125	235	90	6
T30H	125	235	92	6
T40H	125	245	153	6

⚠ Tamper Resistant TORX® Screwdrivers have less strength due to the special design. Make sure to use it correctly.

168T/7-TH	(g)
168T-T10H, T15H, T20H, T25H, T27H, T30H, T40H	480



### 168T/7 (TH)



Set 6 pieces  
Satz 6teilig  
Jeu de 6 tournevis



### 168P (PZ)



Pozidriv Screwdrivers  
Schraubendreher, Pozidriv  
Tournevis pour vis Pozidriv

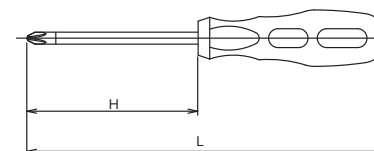
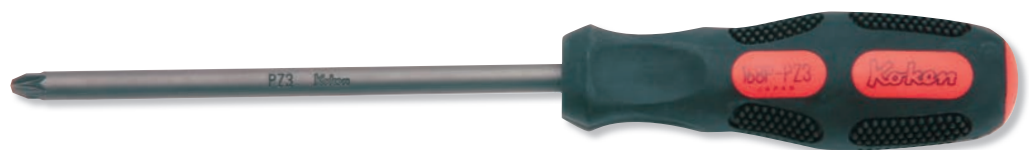

168P (PZ)	H (mm)	L (mm)	(g)	(pcs.)
PZ1	75	175	78	6
PZ2	100	210	129	6
PZ3	150	270	203	6

Screwdrivers  
Schraubendreher  
Tournevis

Z-SERIES  
HAND  
TITANIUM  
ACCESSORIES  
SCREWDRIVERS  
IMPACT  
SLEEVE-DRIVE  
PROTECTOR  
INDUSTRIAL  
AUTOMOTIVE  
MOTORCYCLE  
CONSTRUCTION  
SPARE PART

**166P**  Screwdriver Phillips (Blade-Through type)  
Kreuzschlitz Schraubendreher PH mit durchgehender 6-kant Klinge  
Tournevis pour vis cruciformes Phillips

**166S**  Slotted screwdriver (Blade-Through type)  
Schlitz-Schraubendreher mit durchgehender 6-kant Klinge  
Tournevis pour vis à fente

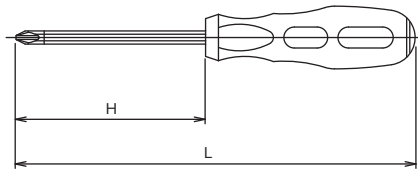
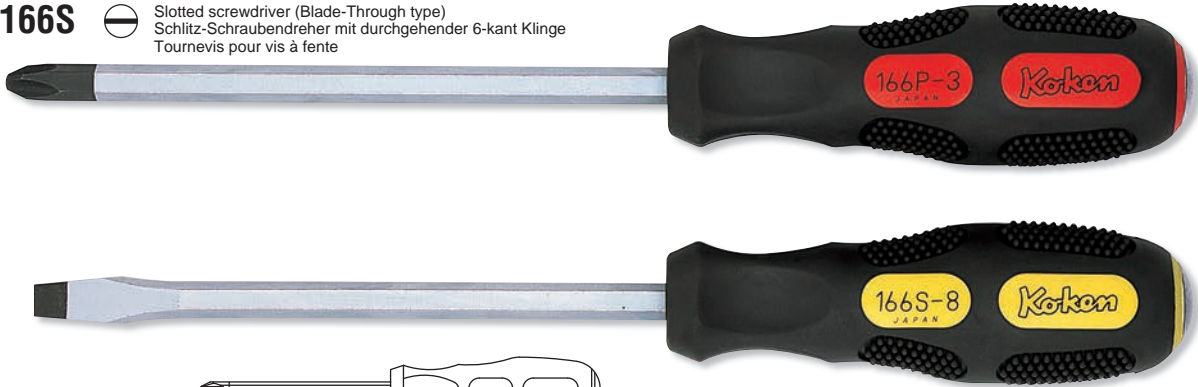



166P (PH)	H (mm)	L (mm)	(g)	(pcs.)
1	75	175	78	6
2	100	210	129	6
3	150	270	203	6

166S	H (mm)	L (mm)	(g)	(pcs.)
5	75	175	78	6
6	100	210	129	6
8	150	270	203	6

**166PS/6**   Set 6 pieces  
Satz 6teilig  
Jeu de 6 tournevis





**166PS/6** 6 Pieces Set/△=885g  
CARDBOARD BOX:W280xH115xT40mm



Screwdrivers	
	<b>166P</b> Screwdrivers 1, 2, 3
	<b>166S</b> Screwdrivers 5, 6, 8

**PK166PS/6**   Set 6 pieces in Plastic Box  
Satz 6teilig in Plastikkassette  
Module plastique des 6 tournevis



**PK166PS/6** 6 Pieces Set/△=950g  
PLASTIC TRAY

Screwdrivers	
	<b>166P</b> Screwdrivers 1, 2, 3
	<b>166S</b> Screwdrivers 5, 6, 8

- 168P**  Screwdriver (Blade-Through Type), Phillips  
Schraubendreher mit durchgehender Klinge, Phillips  
Tournevis à zone de frappe, Phillips
- 168S**  Slotted Screwdriver  
Schlitz-Schraubendreher  
Tournevis pour vis à fente

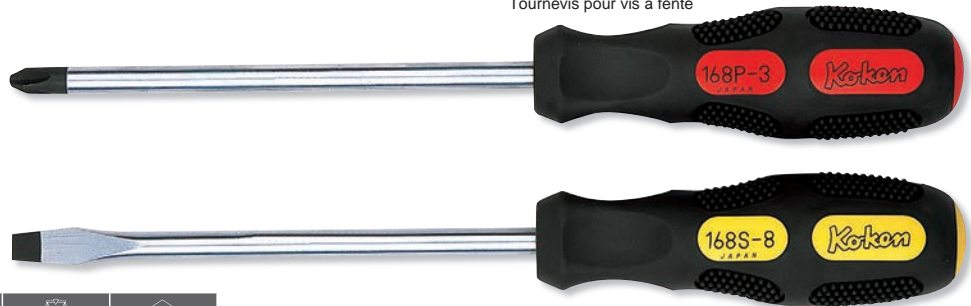
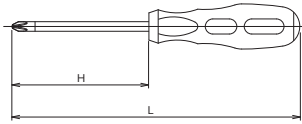

168P (PH)	H (mm)	L (mm)	(g)	(pcs.)
1	75	175	59	6
2	100	210	86	6
2(150)	150	260	100	6
2(200)	200	310	111	6
2(300)	300	410	133	6
3	150	270	150	6

168S	H (mm)	L (mm)	(g)	(pcs.)
5	75	175	59	6
6	100	210	86	6
6(150)	150	260	100	6
6(200)	200	310	111	6
6(300)	300	410	133	6
8	150	270	150	6

168PS/6 6 Pieces Set/△=660g

CARDBOARD BOX:W280xH115xT40mm

Screwdrivers

-  168P Screwdrivers  
1, 2, 3

-  168S Screwdrivers  
5, 6, 8

PK168PS/6 6 Pieces Set/△=720g

PLASTIC TRAY

Screwdrivers

-  168P Screwdrivers  
1, 2, 3

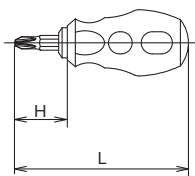

-  168S Screwdrivers  
5, 6, 8



168CS	H (mm)	L (mm)	(g)	(pcs.)
2x6	22	86	46	6

- 168PS/6**   Set 6 pieces  
Satz 6teilig  
Jeu de 6 tournevis





- PK168PS/6**   Set 6 pieces in Plastic Box  
Satz 6teilig in Plastikkassette  
Module plastique des 6 tournevis



- 168CS**   Interchangeable Screwdriver, Stubby  
Schraubendrehergriff für auswechselbare Klinge, kurz  
Poignée porte-lames reversible, court



- 168C**   Interchangeable Screwdriver  
Schraubendrehergriff für auswechselbare Klingen  
Poignée porte-lames reversible

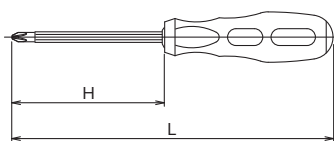

168C	H (mm)	L (mm)	(g)	(pcs.)
2x6	100	210	108	6
2x6(150)	150	260	120	6
2x6(200)	200	310	133	6

Screwdrivers  
Schraubendreher  
Tournevis

Z-SERIES  
HAND  
TITANIUM  
ACCESSORIES  
SCREWDRIVERS  
IMPACT  
SLEEVE-DRIVE  
PROTECTOR  
INDUSTRIAL  
AUTOMOTIVE  
MOTORCYCLE  
CONSTRUCTION  
SPARE PART

**2769N-150 / -220**

Spin Type Handle  
Drehgriff  
Poignée emmanchée

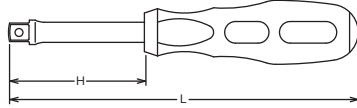

2769N		H (mm)	L (mm)	(g)	(pcs.)
150	1/4"	50	150	68	2
220		120	220	100	2



Plastic or rubber handles are not intended to act as insulation.

Plastik- oder Gummigriffe stellen keinen Isolierschutz dar.

Les poignées en plastique ou en caoutchouc ne garantissent aucune isolation électrique.

**2769NWF-150 / -220**

Spin Type Handle (Wobble-Fix)  
Drehgriff, Wobble-Fix  
Poignée emmanchée, angulaire

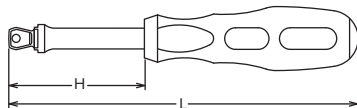

2769NWF		H (mm)	L (mm)	(g)	(pcs.)
150	1/4"	50	150	68	2
220		120	220	100	2

**Wobble-Fix Extension Bar**

Two way usage

- a) In a fixed position, as a normal extension bar
- b) In a half-fixed position, as a flexible extension bar providing a 15° angle operation

**Winkel-Verlängerungen**

Winkelverlängerungen lassen sich in zwei Einstellungen verwenden

- a) voll eingesteckt und starr,
- b) halb eingesteckt, mit einem Arbeitswinkel von 15°.

**Rallonges angulaires**

Deux utilisations possibles

- a) comme rallonge normale, dans une position fixe
- b) comme une rallonge angulaire avec une possibilité d'inclinaison jusqu'à 15°

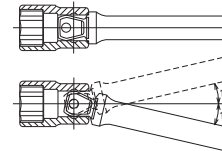

**3769N-160 / -230**

Spin Type Handle  
Drehgriff  
Poignée emmanchée

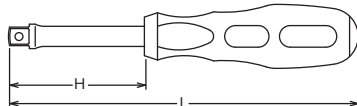

3769N		H (mm)	L (mm)	(g)	(pcs.)
160	3/8"	50	160	96	2
230		120	230	126	2

**3769NWF-160 / -230**

Spin Type Handle (Wobble-Fix)  
Drehgriff, Wobble-Fix  
Poignée emmanchée, angulaire

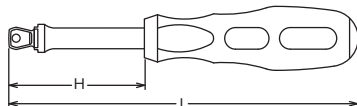

3769NWF		H (mm)	L (mm)	(g)	(pcs.)
160	3/8"	50	160	96	2
230		120	230	126	2



# IMPACT

SOCKETS  
STECKSCHLÜSSEL  
DOUILLES

1/4"

3/8"

1/2"

5/8"

3/4"

1"

1-1/2"

2-1/2"



















































3-1/2"















































# Impact Sockets

## Impact Steckschlüssel

### Douilles Impact

Impact Sockets	Square Drive																
	1/4"(6.35mm)SQ.			3/8"(9.5mm)SQ.			1/2"(12.7mm)SQ.			5/8"(15.9mm)SQ.			3/4"(19mm)SQ.				
	No.	mm	Page	No.	mm	Page	No.	mm	Page	No.	mm	Page	No.	mm	Page		
 Standard Sockets	 6-point (Thin-walled)	12400M 12400A	mm inch	178 178	13400M 13400A	mm inch	182 182	14400M 14400A	mm inch	199 199	15400M	mm	219	16400M 16400A	mm inch	221 221	
	 6-point (with Magnet)	12400MG 12400AG	mm inch	178 178	13400MG 13400AG	mm inch	182 182	14400MG	mm	201				16401M 16401A	mm inch	222 222	
	 12-point (Thin-walled)				13405M 13405A	mm inch	182 182	14405M 14405A	mm inch	199 199				16405M 16405A	mm inch	221 221	
	 Surface	12410M	mm	178	13410M	mm	184	14410M	mm	201		15410M	mm	219	16410M	mm	222
	 PATHFINDER®	12465M	mm	179	13465M	mm	184	14465M	mm	202							
	 TORX® (E)	12425	TORX®	179	13425	TORX®	184	14425	TORX®	202				16425	TORX®	223	
	 TORX® (E) (with Magnet)				13425EG	TORX®	184										
	 TORXplus® (EP)				13425-EPL	TORXplus®	184	14425-EPL	TORXplus®	202				16425-EPL	TORXplus®	223	
	 LH-S				13401LH	LH-STIX®	185	14401LH	LH-STIX®	201							
	 for Self Tapping Screws	12460M 12460A	mm inch	179 179	13460M 13460A	mm inch	185 185										
	 for Self Tapping Screws (with Magnet)	12460MG 12460AG	mm inch	179 179	13460MG 13460AG	mm inch	185 185										
	 Double Square							14415M	mm	202							
	 for Weld Nut				13400-WN		185	14400-WN		202							
	 Short Sockets	 6-point (Thin-walled)				13401MS	mm	183	14401MS	mm	201						
	 Semi Deep Sockets	 6-point (Thin-walled)				13301X	mm	186	14301X	mm	203			16301X	mm	224	
 6-point (with Slide Magnet)					13300XG	mm	186										
 Deep Sockets	 6-point	12300M 12300A	mm	180	13300M 13300A	mm inch	186 186	14300M 14300A	mm inch	203 203	15300M	mm	219	16300M 16300A	mm inch	224 224	
	 6-point (Thin-walled)				13301M 13301A	mm inch	187 187	14301M 14301A	mm inch	204 204			16301M 16301A	mm inch	225 225		
	 6-point (with Slide Magnet)	12300G	mm	180	13300G	mm	188	14300G	mm	205							
	 12-point				13305M	mm	187	14305M	mm	204			16305M	mm	225		
	 12-point (Thin-walled)				13306M	mm	187	14306M	mm	204							
	 Surface				13310M	mm	188	14310M	mm	205	15310M	mm	219	16310M	mm	226	
 PATHFINDER®	12365M	mm	180	13365M	mm	188	14365M	mm	205								
 TORX® (E)				13325	TORX®	188	14325	TORX®	205				16325	TORX®	226		
 Extension Sockets	 6-point				13145M	mm	190	14145M	mm	207							
	 6-point (with Magnet)				13145MG	mm	190										
	 12-point				13145M(12P)	mm	190										
 Universal Sockets	 6-point				13440M 13440A	mm inch	189 189	14440M 14440A	mm inch	206 206							
	 6-point (Extension)				13146M	mm	191	14146M	mm	208							
	 TORX® (E)				13440T	TORX®	189										
 Bit Sockets	 Hexagon				13012M	mm	192	14012M	mm	209							
	 TORX® (T)				13025	TORX®	192	14025	TORX®	209							
 Bit Sockets (Bit changeable)	 Hexagon				13134M	mm	195	14134M	mm	212			16106-16 16107-22	mm mm	227 228		
	 TORX® (T)				13134T(T)	TORX®	195	14134T(T)	TORX®	212							
	 TORXplus® (IP)				13134T(IP)	TORXplus®	195	14134T(IP)	TORXplus®	212							
 Universal Bit Sockets	 XZN (Triple Square)				13134X(XZN)	XZN	195	14134X(XZN)	XZN	212							
	 Hexagon				13430M	mm	189										
	 Hexagon (Extension)				13147M	mm	191	14147M	mm	208							
 Extension Bars		12760		181	13760		197	14760		215			16760		228		
 Universal Joints		12770		181	13770 13771 13772		198 198 198	14770 14771 14772		216 216 216	15770		220	16770 16771		229 229	
	 Adaptors	12233A		181	13322A 13344A		198 198	14433A 14455A 14466A		216 216 216	15544A 15566A		220 220	16644A 16655A 16688A		229 229 229	
	 Locking Adaptors	12222AL		181	13333AL		197	14444AL		215	15555AL		220	16666AL		229	

Impact Sockets		Square Drive											
		1"(25.4mm)SQ.			1.1/2"(38.1mm)SQ.			2.1/2"(63.5mm)SQ.			3.1/2"(88.9mm)SQ.		
		No.	mm	Page	No.	mm	Page	No.	mm	Page	No.	mm	Page
Standard Sockets	 6-point	18400M 18400A	mm inch	231 231	17400M 17400A	mm inch	240 240	19400M 19400A	mm inch	244 244	10400M 10400A	mm inch	246 246
	 6-point (Thin-walled)	18401M 18401A	mm inch	232 232									
	 6-point (with Magnet)												
	 12-point	18405M 18405A	mm inch	232-233 232	17405M 17405A	mm inch	241 241						
	 12-point (Thin-walled)												
	 Surface	18410M	mm	233									
	 PATHFINDER®												
	 TORX® (E)												
	 TORX® (E) (with Magnet)												
	 TORXplus® (EP)												
	 LH-S												
	 for Self Tapping Screws												
	 for Self Tapping Screws (with Magnet)												
	 Double Square												
 for Weld Nut													
Short Sockets	 6-point (Thin-walled)												
Semi Deep Sockets	 6-point (Thin-walled)	18301X	mm	234									
	 6-point (with Slide Magnet)												
Deep Sockets	 6-point	18300M 18300A	mm inch	234 234	17300M 17300A	mm inch	241 241	19300M	mm	245			
	 6-point (Thin-walled)	18301M 18301A	mm inch	235 235									
	 6-point (with Slide Magnet)												
	 12-point												
	 12-point (Thin-walled)												
	 Surface	18310M	mm	235									
	 PATHFINDER®												
Extension Sockets	 TORX® (E)												
	 6-point	18104M	mm	235									
	 6-point (with Magnet)												
Universal Sockets	 12-point												
	 6-point												
	 6-point (Extension)												
Bit Sockets	 TORX® (E)												
	 Hexagon												
Bit Sockets (Bit changeable)	 TORX® (T)												
	 Hexagon	18106-16 18107-22	mm mm	236 237	17108-32	mm	242						
	 TORX® (T)												
	 TORXplus® (IP)												
Universal Bit Sockets	 XZN (Triple Square)												
	 Hexagon												
Extension Bars	 Hexagon (Extension)												
	 Extension Bars	18760		238	17760		243	19760		245			
Universal Joints	 Universal Joints	18770 18771		238 238	17770		243	19770		245			
	 Adaptors	18866A 18877A		239 239	17788A 17799A		243 243	19977A		245	10099A	246	
Locking Adaptors	 Locking Adaptors	18888AL		238									

Z-SERIES  
HAND  
TITANIUM  
ACCESSORIES  
SCREWDRIVERS  
IMPACT  
SLEEVE-DRIVE  
PROTECTOR  
INDUSTRIAL  
AUTOMOTIVE  
MOTORCYCLE  
CONSTRUCTION  
SPARE PART

Z-SERIES  
HAND  
TITANIUM  
SCREWDRIVERS ACCESSORIES  
IMPACT  
SLEEVE-DRIVE  
PROTECTOR  
INDUSTRIAL  
AUTOMOTIVE  
MOTORCYCLE  
CONSTRUCTION  
SPARE PART

## 12400M / 12400A

6-point Sockets  
6-kant Steckschlüssel  
Douilles 6-pans

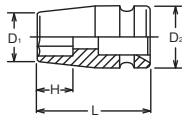

12400A (inch)	D <sub>1</sub> (mm)	D <sub>2</sub> (mm)	H (mm)	L (mm)	(g)	(pcs.)	
5/32	7.5	13	4	23	14	10	*1
3/16	8.1	13	4	23	14	10	*1
7/32	9.4	13	4	23	16	10	*1
1/4	10	13	5	23	14	10	*1
9/32	11.3	13	5	23	14	10	*1
5/16	12.5	13	6	23	14	10	*1
11/32	13.8	13	7	23	14	10	*1
3/8	15	13	7	23	15	10	*1
7/16	16.3	13	8	23	18	10	*1
1/2	18.8	13	8	23	19	10	*1
9/16	20	13	9	23	20	10	*1

\*1 Pin/O-Ring=1200A/B → P255

12400M (mm)	D <sub>1</sub> (mm)	D <sub>2</sub> (mm)	H (mm)	L (mm)	(g)	(pcs.)	
4	7.5	13	4	23	14	10	*1
4.5	8.1	13	4	23	14	10	*1
5	8.8	13	4	23	14	10	*1
5.5	9.4	13	4	23	14	10	*1
6	10	13	5	23	14	10	*1
7	11.3	13	5	23	14	10	*1
8	12.5	13	6	23	14	10	*1
9	13.8	13	7	23	14	10	*1
10	15	13	7	23	15	10	*1
11	16.3	13	8	23	18	10	*1
12	17.5	13	8	23	19	10	*1
13	18.8	13	8	23	19	10	*1
14	20	13	9	23	20	10	*1

\*1 Pin/O-Ring=1200A/B → P255

## 12400MG / 12400AG

6-point Sockets with Magnet  
6-kant Steckschlüssel mit Magnet  
Douilles 6-pans avec aimant

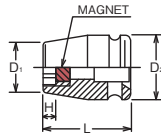

12400AG (inch)	D <sub>1</sub> (mm)	D <sub>2</sub> (mm)	H (mm)	L (mm)	(g)	(pcs.)	
3/16	8.1	13	2.1	23	13	10	*1
1/4	10	13	2.4	23	16	10	*1
5/16	12.5	13	3.5	23	17	10	*1
11/32	13.8	13	3.8	23	18	10	*1
3/8	15	13	4.2	23	18	10	*1
7/16	16.3	13	4.9	23	21	10	*1
1/2	18.8	13	6	25	21	10	*1
9/16	20	13	6.4	25	20	10	*1

\*1 Pin/O-Ring=1200A/B → P255

12400MG (mm)	D <sub>1</sub> (mm)	D <sub>2</sub> (mm)	H (mm)	L (mm)	(g)	(pcs.)	
4	7.5	13	2.1	23	12	10	*1
4.5	8.1	13	2.1	23	13	10	*1
5	8.8	13	2.1	23	15	10	*1
5.5	9.4	13	2.1	23	15	10	*1
6	10	13	2.4	23	16	10	*1
7	11.3	13	2.8	23	16	10	*1
8	12.5	13	3.5	23	17	10	*1
9	13.8	13	3.8	23	18	10	*1
10	15	13	4.2	23	18	10	*1
11	16.3	13	4.9	23	21	10	*1
12	17.5	13	5.6	25	21	10	*1
13	18.8	13	6	25	21	10	*1
14	20	13	6.4	25	20	10	*1

\*1 Pin/O-Ring=1200A/B → P255

## 12410M

Surface Drive Sockets  
Surface Drive Steckschlüssel  
Douilles, Surface Drive

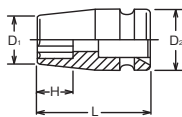

12410M (mm)	D <sub>1</sub> (mm)	D <sub>2</sub> (mm)	H (mm)	L (mm)	(g)	(pcs.)	
6	10	13	5	23	14	10	*1
7	11.3	13	5	23	15	10	*1
8	12.5	13	6	23	15	10	*1
9	13.8	13	7	23	14	10	*1
10	15	13	7	23	14	10	*1
11	16.3	13	8	23	17	10	*1
12	17.5	13	8	23	19	10	*1
13	18.8	13	8	23	19	10	*1

\*1 Pin/O-Ring=1200A/B → P255

## SURFACE DRIVE

Surface drive sockets are designed to retain contact with the flat sides of the nut in order to transmit higher torque and reduce nut wear. These sockets are ideal for using on polished nuts, aluminum nuts and nuts with worn out points.

Das Profil unserer Surface-Drive Steckschlüssel greift die Schraube an deren Flächen. Dies sichert eine höhere Kraftübertragung und verhindert ein Durchrutschen des Steckschlüssels. Diese Steckschlüssel eignen sich besonders für polierte Schrauben, Aluminium Schrauben und Schrauben bei denen die Ecken bereits abgerundet sind.

Notre profil Surface Drive assure le contact entre la douille et les plats de l'écrou. Ceci réduit l'usure et permet la transmission d'un couple plus élevé. C'est une solution idéale pour les écrous polies, celles en aluminium ou arrondies.

# 1/4"

## Impact Sockets Impact Steckschlüssel Douilles Impact

12465M (mm)	D <sub>1</sub> (mm)	D <sub>2</sub> (mm)	H (mm)	L (mm)	(g)	(pcs.)	
10	15	13	8	23	17	10	*1
11	16.3	13	8	23	18	10	*1
12	17.5	13	9	23	18	10	*1
13	18.8	13	9	23	20	10	*1

\*1 Pin/O-Ring=1200A/B → P255



### 12465M Pathfinder Sockets Pathfinder Steckschlüssel Douilles Pathfinder

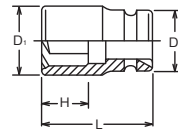

## PATHFINDER®

The beveled flats of the 6-points opening of the PATHFINDER socket engage the nut almost immediately. PATHFINDER sockets are ideal for using with power tools in automatic assembly processes, as the power tool does not have to be totally stopped for the socket to engage the nut.

Da die Maschine nicht nach jedem Schraubvorgang angehalten werden muss, ergibt sich eine erhöhte Produktivität, die sich bei vollautomatischen Maschinen (Mehrspindelschrauber) ganz besonders auswirkt.

Les parois en biais des douilles en 6-pans Pathfinder assurent l'engagement quasi immédiat de l'écrou. Le fait de ne pas devoir arrêter la machine après chaque serrage, engendre une productivité supérieure dans les chaînes de montage automatiques.

12425 (E)	D <sub>1</sub> (mm)	D <sub>2</sub> (mm)	H (mm)	L (mm)	(g)	(pcs.)	
E 4	6.6	13	4.6	23	14	10	*1
E 5	7.7	13	5.2	23	15	10	*1
E 6	8.7	13	5.4	23	15	10	*1
E 7	9.2	13	6.6	23	15	10	*1
E 8	9.7	13	7	23	15	10	*1
E10	12.2	13	8.2	23	15	10	*1

\*1 Pin/O-Ring=1200A/B → P255

### 12425 TORX® Sockets TORX® Steckschlüssel Douilles TORX®

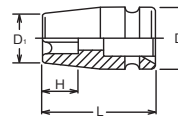

### TORX® (E)

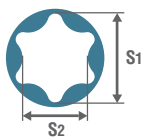

E		E4	E5	E6	E7	E8	E10	E11	E12	E14	E16	E18	E20	E22	E24	E26	E28	E30	E32
S <sub>1</sub>	(ref. mm)	3.7	4.6	5.6	6.1	7.4	9.3	9.9	11.0	12.8	14.6	16.5	18.3	20.1	22.0	23.7	25.5	27.3	29.0
S <sub>2</sub>	(ref. mm)	2.7	3.3	4.0	4.3	5.3	6.8	7.1	7.9	9.2	10.5	11.9	13.2	14.8	15.7	17.5	18.3	20.0	21.3

12460M (mm)	D <sub>1</sub> (mm)	D <sub>2</sub> (mm)	H (mm)	L (mm)	(g)	(pcs.)	
5.5	9.7	13	4	23	15	10	*1
6	10.3	13	5	23	15	10	*1
7	11.6	13	5	23	16	10	*1
8	12.8	13	6	23	16	10	*1
10	15.3	13	7	23	19	10	*1
13	19.1	13	8	23	23	10	*1

12460A (inch)	D <sub>1</sub> (mm)	D <sub>2</sub> (mm)	H (mm)	L (mm)	(g)	(pcs.)	
1/4	10.3	13	5	23	15	10	*1
5/16	12.8	13	6	23	16	10	*1
3/8	15.3	13	7	23	19	10	*1
1/2	19.1	13	8	23	23	10	*1

\*1 Pin/O-Ring=1200A/B → P255

12460MG (mm)	D <sub>1</sub> (mm)	D <sub>2</sub> (mm)	H (mm)	L (mm)	(g)	(pcs.)	
5.5	9.7	13	2.1	23	16	10	*1
6	10.3	13	2.4	23	16	10	*1
7	11.6	13	2.8	23	16	10	*1
8	12.8	13	3.5	25	18	10	*1
10	15.3	13	4.2	28	20	10	*1
12	17.9	13	8	30	41	10	*1
13	19.1	13	6	30	23	10	*1
14	20	13	6.4	30	24	10	*1

12460AG (inch)	D <sub>1</sub> (mm)	D <sub>2</sub> (mm)	H (mm)	L (mm)	(g)	(pcs.)	
1/4	10.3	13	2.4	23	16	10	*1
5/16	12.8	13	3.5	25	18	10	*1
3/8	15.3	13	4.2	28	20	10	*1
7/16	16.6	13	4.9	29	27	10	*1
1/2	19.1	13	6	30	23	10	*1

\*1 Pin/O-Ring=1200A/B → P255

### 12460M / 12460A For Self-Tapping Screws Für selbstschneidende Schrauben Pour vis auto-taraudeuses

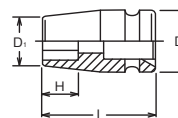

Socket for Self-Tapping Screws without infeed slope.

Steckschlüssel für selbstschneidende Schrauben 6-kant ohne Einlaufschräge.

Douille pour vis auto-taraudeuses hexagonales sans biseau d'entrée.

### 12460MG / 12460AG With Magnet for Self-Tapping Screws mit Magnet für selbstschneidende Schrauben avec aimant pour vis auto-taraudeuses

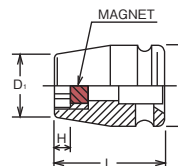

Socket with Magnet for Self-Tapping Screws without infeed slope.

Steckschlüssel mit Magnet für selbstschneidende Schrauben 6-kant ohne Einlaufschräge.

Douille avec aimant pour vis auto-taraudeuses hexagonales sans biseau d'entrée.

# Impact Sockets

## Impact Steckschlüssel

### Douilles Impact

# 1/4"

Z-SERIES  
HAND  
TITANIUM  
SCREWDRIVERS  
ACCESSORIES  
IMPACT  
SLEEVE-DRIVE  
PROTECTOR  
INDUSTRIAL  
AUTOMOTIVE  
MOTORCYCLE  
CONSTRUCTION  
SPARE PART

### 12300M

6-point Sockets, deep  
6-kant Steckschlüssel, lang  
Douilles longues, 6-pans



12300M (mm)	D <sub>1</sub> (mm)	D <sub>2</sub> (mm)	H <sub>1</sub> (mm)	H <sub>2</sub> (mm)	L (mm)	(g)	(pcs.)	
6	10	13	6	38	48	26	10	*1
7	11.3	13	7	38	48	30	10	*1
8	12.5	13	8	38	48	32	10	*1
10	15	13	10	37	48	34	10	*1
11	16.3	13	11	37	48	46	10	*1
12	17.5	13	12	37	48	49	10	*1
13	18.8	13	13	37	48	52	10	*1
14	20	13	14	36	48	57	10	*1

\*1 Pin/O-Ring=1200A/B → P255

### 12365M

Pathfinder Sockets, deep  
Pathfinder Steckschlüssel, lang  
Douilles longues, Pathfinder



12365M (mm)	D <sub>1</sub> (mm)	D <sub>2</sub> (mm)	H <sub>1</sub> (mm)	H <sub>2</sub> (mm)	L (mm)	(g)	(pcs.)	
10	15	13	8	37	48	34	10	*1
11	16.3	13	8	37	48	46	10	*1
12	17.5	13	9	37	48	49	10	*1
13	18.8	13	9	37	48	52	10	*1

\*1 Pin/O-Ring=1200A/B → P255

### 12300G

Impact Socket with Sliding Magnet  
Impact Steckschlüssel mit versenkbarem Magnet  
Douilles Impact avec aimant, glissant pour écrous

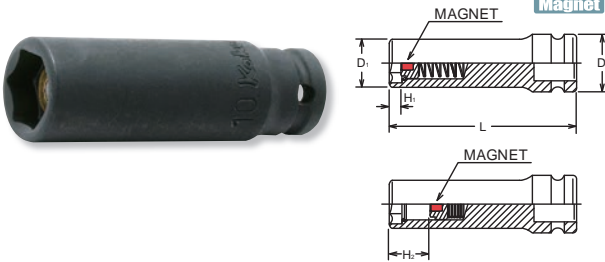

12300G (mm)	D <sub>1</sub> (mm)	D <sub>2</sub> (mm)	H <sub>1</sub> (mm)	H <sub>2</sub> (mm)	L (mm)	(g)	(pcs.)	
8	12.5	13	4	22	48	32	10	*1
10	15	13	4.5	20.5	48	34	10	*1
12	17.5	13	6	24.5	48	49	10	*1
13	18.8	13	6.5	23	48	52	10	*1
14	20	13	7	21	48	57	10	*1

\*1 Pin/O-Ring=1200A/B → P255

### 12139

Impact Bit Holder  
Impact Klingenhalter  
Porte embouts Impact



	D <sub>1</sub> (mm)	D <sub>2</sub> (mm)	L (mm)	(g)	(pcs.)	
12139-1/4	11	13	25	15	10	*1

\*1 Pin/O-Ring=1200A/B → P255

For DIN3126 C6.3 Bits  
Für DIN3126 C6.3 Bits  
Pour DIN3126 C6.3 Embouts

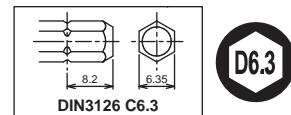

### 12140

Impact Bit Holder  
Impact Klingenhalter  
Porte embouts Impact



	D <sub>1</sub> (mm)	D <sub>2</sub> (mm)	L (mm)	(g)	(pcs.)	
12140-5/16	14	13	25	15	10	*1

\*1 Pin/O-Ring=1200A/B → P255

For DIN3126 C8 Bits  
Für DIN3126 C8 Bits  
Pour DIN3126 C8 Embouts

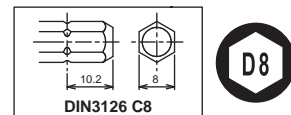

### 12142-F6.3

Impact Bit Holder  
Impact Klingenhalter  
Porte embouts Impact

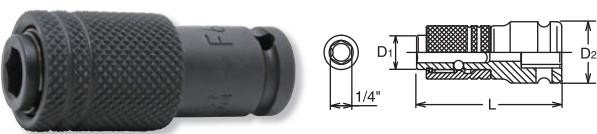

	D <sub>1</sub> (mm)	D <sub>2</sub> (mm)	L (mm)	(g)	(pcs.)	
12142-F6.3	16.5	13	40	22	10	*1

\*1 Pin/O-Ring=1200A/B → P255

For DIN3126 E6.3 Bits  
Für DIN3126 E6.3 Bits  
Pour DIN3126 E6.3 Embouts

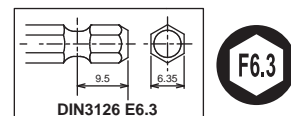

#### Lock & Quick Release

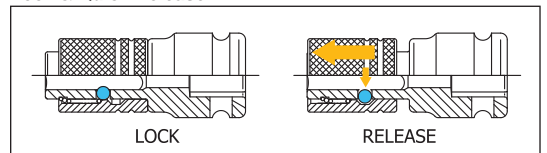

**⚠** You may not hold the sliding part while moving to avoid heating up by friction and reduction by wear.

	TYPE	D (mm)	L (mm)	(g)	(pcs.)	
12760-55P	Pin	13	55	26	10	*1
12760-55	Hole	13	55	26	10	*1
12760-75P	Pin	13	75	45	10	*1
12760-75	Hole	13	75	45	10	*1
12760-100P	Pin	13	100	50	10	*1
12760-100	Hole	13	100	50	10	*1
12760-150P	Pin	13	150	60	10	*1
12760-150	Hole	13	150	60	10	*1
12760-200P	Pin	13	200	80	10	*1

\*1 Pin/O-Ring=1200A/B → P255

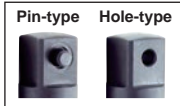

	L (mm)	(g)	(pcs.)	
12222AL	35	30	10	*1

\*1 Pin/O-Ring=1200A/B → P255

### Lock & Quick Release

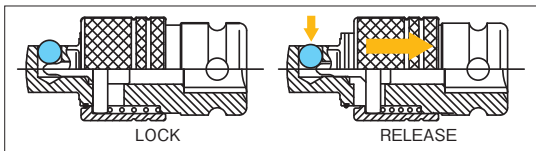

**⚠** You may not hold the sliding part while moving to avoid heating up by friction and reduction by wear.



### 12760-P 12760

Extension Bars  
Verlängerungen  
Rallonges

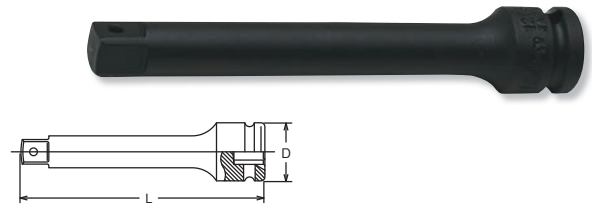

### 12222AL

Adaptor (Quick Release)  
Schnellwechsel-Verbindungsstück  
Adaptateur autoserrant **⚠**



### 12770-P 12770

Universal Joint  
Gelenk-Einsatz  
Joint articulé



	TYPE	L (mm)	(g)	(pcs.)	
12770-P	Pin	39	30	10	*1
12770	Hole	39	30	10	*1

\*1 Pin/O-Ring=1200A/B → P255

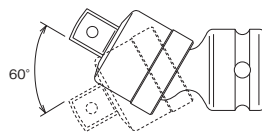

Our ball joints are spring-loaded and can therefore be adjusted to an angle of max. 30°.

Unsere Kugelgelenke sind federbelastet dadurch sind sie auf einen Winkel von max 30° einstellbar.

Nos joints à rotule sont à ressort et peuvent donc être réglés jusqu'à un angle de 30° maximum.

	TYPE	(sq.)	(sq.)	L (mm)	(g)	(pcs.)	
12233A-P	Pin	1/4"	3/8"	22	15	10	*1
12233A	Hole	1/4"	3/8"	22	15	10	*1

\*1 Pin/O-Ring=1200A/B → P255

### 12233A-P 12233A

Adaptor  
Verbindungsstück  
Augmentateur



Impact Sockets  
Impact Steckschlüssel  
Douilles Impact

# 3/8"

Z-SERIES

HAND

TITANIUM

ACCESSORIES

SREWDRIERS

IMPACT

SLEEVE-DRIVE

PROTECTOR

INDUSTRIAL

AUTOMOTIVE

MOTORCYCLE

CONSTRUCTION

SPARE PART

## 13400M / 13400A

6-point Sockets  
6-kant Steckschlüssel  
Douilles 6-pans

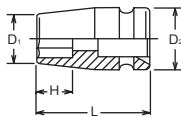

13400A (inch)	D <sub>1</sub> (mm)	D <sub>2</sub> (mm)	H (mm)	L (mm)	(g)	(pcs.)	(V)
1/4	10.8	19	5	32	40	10	*1
5/16	13.3	19	6	32	40	10	*1
3/8	15.8	19	7	32	40	10	*1
7/16	17	19	8	32	41	10	*1
1/2	19.5	22	10	32	56	10	*2
9/16	20.8	22	10	32	56	10	*2
5/8	23.3	22	11	32	57	10	*2
11/16	24.5	22	12	32	60	10	*2
3/4	27	22	12	32	67	10	*2
13/16	29.5	22	12	32	71	10	*2
7/8	30.8	22	13	32	72	10	*2

\*1 C-Ring=1301C, Pin/O-Ring=1301A/B  
\*2 C-Ring=1302C, Pin/O-Ring=1302A/B [→ P254-255](#)

13400M (mm)	D <sub>1</sub> (mm)	D <sub>2</sub> (mm)	H (mm)	L (mm)	(g)	(pcs.)	(V)
6	10.8	19	5	32	40	10	*1
7	12	19	5	32	40	10	*1
8	13.3	19	6	32	40	10	*1
9	14.5	19	7	32	40	10	*1
10	15.8	19	7	32	40	10	*1
11	17	19	8	32	41	10	*1
12	18.3	19	9	32	43	10	*1
13	19.5	22	10	32	56	10	*2
14	20.8	22	10	32	56	10	*2
15	22	22	11	32	56	10	*2
16	23.3	22	11	32	57	10	*2
17	24.5	22	12	32	60	10	*2
18	25.8	22	12	32	62	10	*2
19	27	22	12	32	67	10	*2
20	28.3	22	12	32	70	10	*2
21	29.5	22	12	32	71	10	*2
22	30.8	22	13	32	72	10	*2
23	32	22	13	32	75	10	*2
24	33.3	22	13	32	78	10	*2

\*1 C-Ring=1301C, Pin/O-Ring=1301A/B  
\*2 C-Ring=1302C, Pin/O-Ring=1302A/B [→ P254-255](#)

## 13405M / 13405A

12-point Sockets  
12-kant Steckschlüssel  
Douilles 12-pans

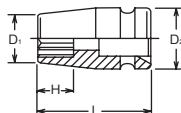

13405A (inch)	D <sub>1</sub> (mm)	D <sub>2</sub> (mm)	H (mm)	L (mm)	(g)	(pcs.)	(V)
1/4	10.8	19	5	32	40	10	*1
5/16	13.3	19	6	32	40	10	*1
3/8	15.8	19	7	32	40	10	*1
7/16	17	19	8	32	41	10	*1
1/2	19.5	22	10	32	56	10	*2
9/16	20.8	22	10	32	56	10	*2
5/8	23.3	22	11	32	57	10	*2
11/16	24.5	22	12	32	60	10	*2
3/4	27	22	12	32	67	10	*2
13/16	29.5	22	12	32	71	10	*2
7/8	30.8	22	13	32	72	10	*2

\*1 C-Ring=1301C, Pin/O-Ring=1301A/B  
\*2 C-Ring=1302C, Pin/O-Ring=1302A/B [→ P254-255](#)

13405M (mm)	D <sub>1</sub> (mm)	D <sub>2</sub> (mm)	H (mm)	L (mm)	(g)	(pcs.)	(V)
8	13.3	19	6	32	40	10	*1
9	14.5	19	7	32	40	10	*1
10	15.8	19	7	32	40	10	*1
11	17	19	8	32	41	10	*1
12	18.3	19	9	32	43	10	*1
13	19.5	22	10	32	56	10	*2
14	20.8	22	10	32	56	10	*2
15	22	22	11	32	56	10	*2
16	23.3	22	11	32	57	10	*2
17	24.5	22	12	32	60	10	*2
18	25.8	22	12	32	62	10	*2
19	27	22	12	32	67	10	*2

\*1 C-Ring=1301C, Pin/O-Ring=1301A/B  
\*2 C-Ring=1302C, Pin/O-Ring=1302A/B [→ P254-255](#)

## 13400MG / 13400AG

6-point Sockets with Magnet  
6-kant Steckschlüssel mit Magnet  
Douilles 6-pans avec aimant

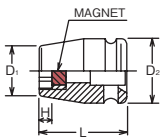

13400AG (inch)	D <sub>1</sub> (mm)	D <sub>2</sub> (mm)	H (mm)	L (mm)	(g)	(pcs.)	(V)
1/4	10.8	19	2.4	32	46	10	*1
5/16	13.3	19	3.5	32	45	10	*1
11/32	14.5	19	3.8	32	44	10	*1
3/8	15.8	19	4.2	32	49	10	*1
7/16	17	19	4.9	32	50	10	*1
1/2	19.5	22	6	32	70	10	*2
9/16	20.8	22	6.4	32	76	10	*2
5/8	23.3	22	7	32	88	10	*2
11/16	24.5	22	7.5	32	95	10	*2
3/4	27	22	8	32	116	10	*2

\*1 C-Ring=1301C, Pin/O-Ring=1301A/B  
\*2 C-Ring=1302C, Pin/O-Ring=1302A/B [→ P254-255](#)

13400MG (mm)	D <sub>1</sub> (mm)	D <sub>2</sub> (mm)	H (mm)	L (mm)	(g)	(pcs.)	(V)
6	10.8	19	2.4	32	46	10	*1
7	12	19	2.8	32	45	10	*1
8	13.3	19	3.5	32	45	10	*1
9	14.5	19	3.8	32	44	10	*1
10	15.8	19	4.2	32	49	10	*1
11	17	19	4.9	32	50	10	*1
12	18.3	19	5.6	32	55	10	*1
13	19.5	22	6	32	70	10	*2
14	20.8	22	6.4	32	76	10	*2
15	22	22	6.8	32	76	10	*2
16	23.3	22	7	32	88	10	*2
17	24.5	22	7.5	32	95	10	*2
18	25.8	22	7.8	32	105	10	*2
19	27	22	8	32	116	10	*2
21	29.5	22	8	32	125	10	*2
22	30.8	22	9.5	32	135	10	*2

\*1 C-Ring=1301C, Pin/O-Ring=1301A/B  
\*2 C-Ring=1302C, Pin/O-Ring=1302A/B [→ P254-255](#)



# 3/8"

## Impact Sockets Impact Steckschlüssel Douilles Impact

13401M (mm)	D <sub>1</sub> (mm)	D <sub>2</sub> (mm)	H (mm)	L (mm)	(g)	(pcs.)	
6	9.8	18.5	5	32	28	10	*1
7	11	18.5	5	32	30	10	*1
8	12.3	18.5	6	32	31	10	*1
9	13.5	18.5	7	32	32	10	*1
10	14.8	18.5	7	32	34	10	*1
11	16	18.5	8	32	35	10	*1
12	17.3	18.5	9	32	36	10	*1
13	18.5	21.5	10	32	43	10	*2
14	19.8	21.5	10	32	49	10	*2
15	21	21.5	11	32	49	10	*2
16	22.3	21.5	11	32	51	10	*2
17	23.5	21.5	12	32	54	10	*2
18	24.8	21.5	12	32	57	10	*2
19	26	21.5	12	32	60	10	*2
20	27.3	21.5	12	32	65	10	*2
21	28.5	21.5	12	32	70	10	*2
22	29.8	21.5	13	32	73	10	*2
23	31	21.5	13	32	73	10	*2
24	32.3	21.5	13	32	75	10	*2

\*1 C-Ring=1301C, Pin/O-Ring=1301A/B  
\*2 C-Ring=1302C, Pin/O-Ring=1302A/B

→ P254-255

RS13401M/9	9 Pieces Set/Rail 250mm	(g)
8, 10, 12, 13, 14, 17, 19, 21, 22		505

### 13401M / 13401A

6-point Socket, Thin Walled  
6-kant Steckschlüssel, dünnwandig  
Douilles à pari mince, 6-pans

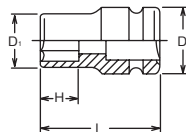

13401A (inch)	D <sub>1</sub> (mm)	D <sub>2</sub> (mm)	H (mm)	L (mm)	(g)	(pcs.)	
1/4	9.8	18.5	5	32	28	10	*1
5/16	12.3	18.5	6	32	31	10	*1
3/8	14.8	18.5	7	32	34	10	*1
7/16	16	18.5	8	32	35	10	*1
1/2	18.5	21.5	10	32	43	10	*2
9/16	19.8	21.5	10	32	49	10	*2
5/8	22.3	21.5	11	32	51	10	*2
11/16	23.5	21.5	12	32	54	10	*2
3/4	26	21.5	12	32	60	10	*2
13/16	28.5	21.5	12	32	70	10	*2
7/8	29.8	21.5	13	32	73	10	*2

\*1 C-Ring=1301C, Pin/O-Ring=1301A/B  
\*2 C-Ring=1302C, Pin/O-Ring=1302A/B

→ P254-255

### RS13401M/9

Socket Set on Rail  
Steckschlüsselsatz auf Schiene  
Jeu de douilles sur rail



### 13406M / 13406A

12-point Socket, Thin Walled  
12-kant Steckschlüssel, dünnwandig  
Douilles à pari mince, 12-pans

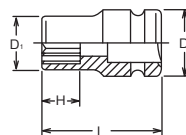

13406M (mm)	D <sub>1</sub> (mm)	D <sub>2</sub> (mm)	H (mm)	L (mm)	(g)	(pcs.)	
6	9.8	18.5	5	32	28	10	*1
7	11	18.5	5	32	30	10	*1
8	12.3	18.5	6	32	31	10	*1
9	13.5	18.5	7	32	32	10	*1
10	14.8	18.5	7	32	34	10	*1
11	16	18.5	8	32	35	10	*1
12	17.3	18.5	9	32	36	10	*1
13	18.5	21.5	10	32	43	10	*2
14	19.8	21.5	10	32	49	10	*2
15	21	21.5	11	32	49	10	*2
16	22.3	21.5	11	32	51	10	*2
17	23.5	21.5	12	32	54	10	*2
18	24.8	21.5	12	32	57	10	*2
19	26	21.5	12	32	60	10	*2
20	27.3	21.5	12	32	65	10	*2
21	28.5	21.5	12	32	70	10	*2
22	29.8	21.5	13	32	73	10	*2
23	31	21.5	13	32	73	10	*2
24	32.3	21.5	13	32	75	10	*2

\*1 C-Ring=1301C, Pin/O-Ring=1301A/B  
\*2 C-Ring=1302C, Pin/O-Ring=1302A/B

→ P254-255

\*1 C-Ring=1301C, Pin/O-Ring=1301A/B  
\*2 C-Ring=1302C, Pin/O-Ring=1302A/B

→ P254-255

13401MS (mm)	D <sub>1</sub> (mm)	D <sub>2</sub> (mm)	H (mm)	L (mm)	(g)	(pcs.)	
8	12.3	18.5	6	22	25	10	*1
10	14.8	18.5	6	22	25	10	*1
12	17.3	18.5	10	22	20	10	*1
13	18.5	21.5	10	22	30	10	*2
14	19.8	21.5	10	22	30	10	*2

\*1 C-Ring=1301C, Pin/O-Ring=1301A/B  
\*2 C-Ring=1302C, Pin/O-Ring=1302A/B

→ P254-255

### 13401MS

6-point short sockets, Thin Walled  
6-kant Steckschlüssel kurz, dünnwandig  
Douilles 6-pans courtes, a pari mince

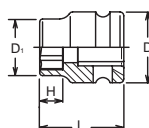

RS13401MS/5	5 Pieces Set/Rail 150mm	(g)
8, 10, 12, 13, 14		180

### RS13401MS/5

Socket Set on Rail  
Steckschlüsselsatz auf Schiene  
Jeu de douilles sur rail



# Impact Sockets

## Impact Steckschlüssel

### Douilles Impact

# 3/8"

Z-SERIES  
HAND  
TITANIUM  
SCREWDRIVERS ACCESSORIES  
IMPACT  
SLEEVE-DRIVE  
PROTECTOR  
INDUSTRIAL  
AUTOMOTIVE  
MOTORCYCLE  
CONSTRUCTION  
SPARE PART

### 13410M

Surface Drive Sockets  
Surface Drive Steckschlüssel  
Douilles, Surface Drive

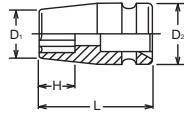

13410M (mm)	D <sub>1</sub> (mm)	D <sub>2</sub> (mm)	H (mm)	L (mm)	(g)	(pcs.)	
6	10.8	19	5	32	40	10	*1
7	12	19	5	32	40	10	*1
8	13.3	19	6	32	40	10	*1
9	14.5	19	7	32	40	10	*1
10	15.8	19	7	32	40	10	*1
11	17	19	8	32	42	10	*1
12	18.3	19	9	32	50	10	*1
13	19.5	22	10	32	56	10	*2
14	20.8	22	10	32	56	10	*2
15	22	22	11	32	56	10	*2
16	23.3	22	11	32	57	10	*2
17	24.5	22	12	32	60	10	*2
18	25.8	22	12	32	62	10	*2
19	27	22	12	32	67	10	*2
22	30.8	22	13	32	72	10	*2

\*1 C-Ring=1301C, Pin/O-Ring=1301A/B → P254-255  
\*2 C-Ring=1302C, Pin/O-Ring=1302A/B

### 13465M

Pathfinder Sockets  
Pathfinder Steckschlüssel  
Douilles Pathfinder

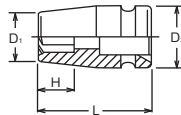

13465M (mm)	D <sub>1</sub> (mm)	D <sub>2</sub> (mm)	H (mm)	L (mm)	(g)	(pcs.)	
8	13.3	19	8	32	40	10	*1
10	15.8	19	8	32	43	10	*1
11	17	19	8	32	44	10	*1
12	18.3	19	9	32	47	10	*1
13	19.5	22	9	32	55	10	*2
14	20.8	22	11	32	56	10	*2
15	22	22	11	32	56	10	*2
16	23.3	22	11	32	57	10	*2
17	24.5	22	12	32	60	10	*2
18	25.8	22	13	32	63	10	*2
19	27	22	13	32	66	10	*2

\*1 C-Ring=1301C, Pin/O-Ring=1301A/B → P254-255  
\*2 C-Ring=1302C, Pin/O-Ring=1302A/B

### 13425

TORX® Sockets  
TORX® Steckschlüssel  
Douilles TORX®

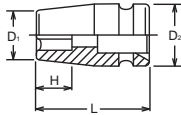

13425 (E)	D <sub>1</sub> (mm)	D <sub>2</sub> (mm)	H (mm)	L (mm)	(g)	(pcs.)	
E 4	9.7	19	4.6	32	44	10	*1
E 5	10.2	19	5.2	32	43	10	*1
E 6	10.7	19	5.4	32	44	10	*1
E 7	11.2	19	6.6	32	44	10	*1
E 8	11.7	19	7	32	44	10	*1
E10	12.2	19	8.2	32	42	10	*1
E12	14.2	19	9.3	32	43	10	*1
E14	17.2	19	10.6	32	44	10	*1
E16	18.2	19	11.8	32	42	10	*1

\*1 C-Ring=1301C, Pin/O-Ring=1301A/B → P254-255

### 13425EG

TORX® Sockets with Magnet  
TORX® Steckschlüssel mit Magnet  
Douilles TORX® avec aimant

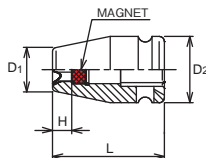

13425EG (E)	D <sub>1</sub> (mm)	D <sub>2</sub> (mm)	H (mm)	L (mm)	(g)	(pcs.)	
New E 8	11.7	19	5	32	54	10	*1
New E10	12.2	19	5.5	32	52	10	*1
New E12	14.2	19	6.5	32	53	10	*1
New E14	17.2	19	7	32	54	10	*1

\*1 C-Ring=1301C, Pin/O-Ring=1301A/B → P254-255

### 13425-EPL

TORXPLUS® Sockets  
TORXPLUS® Steckschlüssel  
Douilles TORXPLUS®

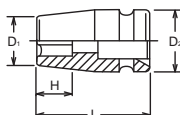

13425 (EPL)	D <sub>1</sub> (mm)	D <sub>2</sub> (mm)	H (mm)	L (mm)	(g)	(pcs.)	
8EPL	12	19	5.2	32	44	10	*1
10EPL	13.3	19	6.2	32	44	10	*1
12EPL	15.8	19	7.2	32	44	10	*1
14EPL	18.3	19	8.1	32	46	10	*1
16EPL	19.5	19	9.2	32	41	10	*1

\*1 C-Ring=1301C, Pin/O-Ring=1301A/B → P254-255

# 3/8"

Impact Sockets  
Impact Steckschlüssel  
Douilles Impact

13460M (mm)	D <sub>1</sub> (mm)	D <sub>2</sub> (mm)	H (mm)	L (mm)	(g)	(pcs.)	
6	11.4	19	5	32	43	10	*1
7	12.8	19	5	32	44	10	*1
8	14.1	19	6	32	44	10	*1
10	16.6	19	7	32	45	10	*1
12	19	19.2	9	32	48	10	*2
13	20.3	22	10	32	60	10	*2

13460A (inch)	D <sub>1</sub> (mm)	D <sub>2</sub> (mm)	H (mm)	L (mm)	(g)	(pcs.)	
1/4	11.4	19	5	32	43	10	*1
3/8	16.6	19	7	32	45	10	*1
1/2	20.3	22	10	32	60	10	*2

\*1 C-Ring=1301C, Pin/O-Ring=1301A/B  
\*2 C-Ring=1302C, Pin/O-Ring=1302A/B → P254-255

13460MG (mm)	D <sub>1</sub> (mm)	D <sub>2</sub> (mm)	H (mm)	L (mm)	(g)	(pcs.)	
6	11.4	19	2.4	32	44	10	*1
7	12.8	19	2.8	32	46	10	*1
8	14.1	19	3.5	32	48	10	*1
10	16.6	19	4.2	33	54	10	*1
13	20.3	22	6	34	81	10	*2

13460AG (inch)	D <sub>1</sub> (mm)	D <sub>2</sub> (mm)	H (mm)	L (mm)	(g)	(pcs.)	
1/4	11.4	19	2.4	32	44	10	*1
5/16	14.1	19	3.5	32	48	10	*1
3/8	16.6	19	4.2	33	54	10	*1
1/2	20.3	22	6	34	81	10	*2

\*1 C-Ring=1301C, Pin/O-Ring=1301A/B  
\*2 C-Ring=1302C, Pin/O-Ring=1302A/B → P254-255

13401LH (LH-S)	D <sub>1</sub> (mm)	D <sub>2</sub> (mm)	H (mm)	L (mm)	(g)	(pcs.)	
5S	11	19	5	32	32	10	*1
6S	12.3	19	5.6	32	34	10	*1
8S	16	19	6.8	32	36	10	*1
10S	18.5	22	8	32	50	10	*2
12S	22.3	22	9.2	32	58	10	*2
14S	24.8	22	10.4	32	63	10	*2
16S	28.5	22	11.6	32	77	10	*2

\*1 C-Ring=1301C, Pin/O-Ring=1301A/B  
\*2 C-Ring=1302C, Pin/O-Ring=1302A/B → P254-255

LHSTIX®

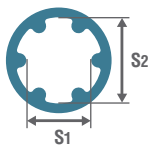

LH-S		LH-5S	LH-6S	LH-8S	LH-10S	LH-12S	LH-14S	LH-16S
S <sub>1</sub>	(ref. mm)	5.6	6.8	9.0	11.3	13.6	15.8	18.1
S <sub>2</sub>	(ref. mm)	7.5	9.0	12.0	15.0	18.0	21.0	24.0

13400-WN	D <sub>1</sub> (mm)	D <sub>2</sub> (mm)	H (mm)	L (mm)	(g)	(pcs.)	
6WN	15.8	19	6	32	48	10	*1
8WN	18.3	19	8	32	48	10	*1
9WN	19.5	22	9	32	47	10	*2
10WN	20.8	22	10	32	65	10	*2
12WN	24.5	22	12	32	73	10	*2
14WN	27	22	14	32	79	10	*2
17WN	32	22	17	35	110	10	*2

\*1 C-Ring=1301C, Pin/O-Ring=1301A/B  
\*2 C-Ring=1302C, Pin/O-Ring=1302A/B → P254-255

WN



WN		6WN	8WN	9WN	10WN	12WN	14WN	17WN
S	(ref. mm)	6	8	9	10	12	14	17

## 13460M / 13460A

For Self-Tapping Screws  
Für selbstschneidende Schrauben  
Pour vis auto-taraudeuses

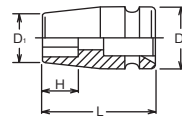

Socket for Self-Tapping Screws without infeed slope.

Steckschlüssel für selbstschneidende Schrauben 6-kant ohne Einlaufschräge.

Douille pour vis auto-taraudeuses hexagonales sans biseau d'entrée.

## 13460MG / 13460AG

Sockets with magnets for Self-Tapping Screws  
Steckschlüssel mit Magnet für selbstschneidende Schrauben  
Douilles avec aimant pour vis auto-taraudeuses

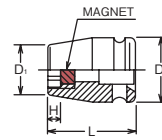

Socket with Magnet for Self-Tapping Screws without infeed slope.

Steckschlüssel mit Magnet für Selbstschneidende Schrauben 6-kant ohne Einlaufschräge.

Douille avec aimant pour vis auto-taraudeuses hexagonales sans biseau d'entrée.

## 13401LH

LHS Sockets  
Steckschlüssel mit LHS Profil  
Douilles au profil LHS

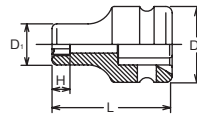

## 13400-WN

Weld Nut Sockets  
Steckschlüssel für Schweissmuttern  
Douilles pour écrou à souder

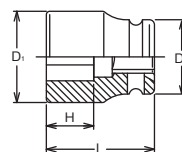

Impact Sockets  
Impact Steckschlüssel  
Douilles Impact

3/8"

Z-SERIES  
HAND  
TITANIUM  
SCREWDRIVERS ACCESSORIES  
IMPACT  
SLEEVE-DRIVE  
PROTECTOR  
INDUSTRIAL  
AUTOMOTIVE  
MOTORCYCLE  
CONSTRUCTION  
SPARE PART

**13301X**  6-point Semi-Deep Socket, Thin Walled  
6-kant Steckschlüssel mittel lang, dünnwandig  
Douilles à paroi mince semi-longues, 6-pans

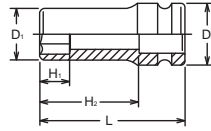

13301X (mm)	D <sub>1</sub> (mm)	D <sub>2</sub> (mm)	H <sub>1</sub> (mm)	H <sub>2</sub> (mm)	L (mm)	(g)	(pcs.)	
7	11	18.5	7	36.5	50	40	10	*1
8	12.3	18.5	8	36.5	50	40	10	*1
10	14.8	18.5	10	36.5	50	46	10	*1
11	16	18.5	11	36.5	50	49	10	*1
12	17.3	18.5	12	36.5	50	53	10	*1
13	18.5	21.5	13	36.5	50	67	10	*2
14	19.8	21.5	14	36.5	50	70	10	*2
15	21	21.5	15	35.5	50	75	10	*2
16	22.3	21.5	16	35.5	50	78	10	*2
17	23.5	21.5	17	35.5	50	82	10	*2
18	24.8	21.5	18	34.5	50	86	10	*2
19	26	21.5	19	34.5	50	93	10	*2
21	28.5	21.5	21	34.5	50	104	10	*2
22	29.8	21.5	22	33.5	50	110	10	*2
23	31	21.5	23	33.5	50	115	10	*2
24	32.3	21.5	24	32.5	50	120	10	*2

\*1 C-Ring=1301C, Pin/O-Ring=1301A/B  
\*2 C-Ring=1302C, Pin/O-Ring=1302A/B

**RS13301X/9**   Socket Set on Rail  
Steckschlüsselsatz auf Schiene  
Jeu de douilles sur rail



RS13301X/9	9 Pieces Set/Rail 250mm	(g)
8, 10, 12, 13, 14, 17, 19, 21, 22		710

**13300XG**  Impact semi-deep socket with Sliding Magnet  
Impact Steckschlüssel mittel lang mit versenkbarem Magnet  
Douilles semi-longues avec aimant, glissant pour écrous

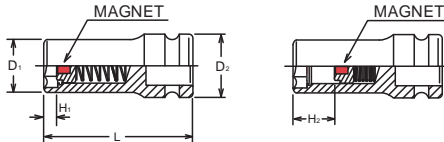

13300XG (mm)	D <sub>1</sub> (mm)	D <sub>2</sub> (mm)	H <sub>1</sub> (mm)	H <sub>2</sub> (mm)	L (mm)	(g)	(pcs.)	
7	12	19	3.5	19	50	52	10	*1
8	13.3	19	4	20.5	50	40	10	*1
10	15.8	19	4.5	20	50	46	10	*1
11	17	19	5	20	50	50	10	*1
12	18.3	19	6	20	50	55	10	*1
13	19.5	22	6.5	19	50	70	10	*2
14	20.8	22	7	18	50	75	10	*2
New 16	23.2	22	7.5	20	50	114	10	*2
New 17	24.4	22	8	20	50	126	10	*2

\*1 C-Ring=1301C, Pin/O-Ring=1301A/B  
\*2 C-Ring=1302C, Pin/O-Ring=1302A/B

**13300M / 13300A**  6-point Sockets, deep  
6-kant Steckschlüssel, lang  
Douilles longues, 6-pans

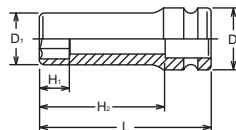

13300M (mm)	D <sub>1</sub> (mm)	D <sub>2</sub> (mm)	H <sub>1</sub> (mm)	H <sub>2</sub> (mm)	L (mm)	(g)	(pcs.)	
6	10.8	19	6	66.5	80	77	10	*1
7	12	19	7	66.5	80	82	10	*1
8	13.3	19	8	66.5	80	82	10	*1
9	14.5	19	9	66.5	80	88	10	*1
10	15.8	19	10	66.5	80	94	10	*1
11	17	19	11	66.5	80	110	10	*1
12	18.3	19	12	66.5	80	111	10	*1
13	19.5	22	13	66.5	80	138	10	*2
14	20.8	22	14	66.5	80	148	10	*2
15	22	22	15	65.5	80	157	10	*2
16	23.3	22	16	65.5	80	156	10	*2
17	24.5	22	17	65.5	80	168	10	*2
18	25.8	22	18	64.5	80	190	10	*2
19	27	22	19	64.5	80	192	10	*2
20	28.3	22	20	64.5	80	224	10	*2
21	29.5	22	21	64.5	80	226	10	*2
22	30.8	22	22	63.5	80	231	10	*2
24	33.2	22	24	63.5	80	242	10	*2

13300A (inch)	D <sub>1</sub> (mm)	D <sub>2</sub> (mm)	H <sub>1</sub> (mm)	H <sub>2</sub> (mm)	L (mm)	(g)	(pcs.)	
1/4	10.8	19	6	66.5	80	77	10	*1
5/16	13.3	19	8	66.5	80	82	10	*1
3/8	15.8	19	10	66.5	80	94	10	*1
7/16	17	19	11	66.5	80	110	10	*1
1/2	19.5	22	13	66.5	80	138	10	*2
9/16	20.8	22	14	66.5	80	148	10	*2
5/8	23.3	22	16	65.5	80	156	10	*2
11/16	24.5	22	17	65.5	80	168	10	*2
3/4	27	22	19	64.5	80	192	10	*2
13/16	29.5	22	21	64.5	80	226	10	*2
7/8	30.8	22	22	63.5	80	231	10	*2

\*1 C-Ring=1301C, Pin/O-Ring=1301A/B  
\*2 C-Ring=1302C, Pin/O-Ring=1302A/B

13301M (mm)	D <sub>1</sub> (mm)	D <sub>2</sub> (mm)	H <sub>1</sub> (mm)	H <sub>2</sub> (mm)	L (mm)	(g)	(pcs.)	
6	10	18.5	6	66.5	80	65	10	*1
7	11	18.5	7	66.5	80	66	10	*1
8	12.3	18.5	8	66.5	80	68	10	*1
9	13.5	18.5	9	66.5	80	70	10	*1
10	14.8	18.5	10	66.5	80	72	10	*1
11	16	18.5	11	66.5	80	80	10	*1
12	17.3	18.5	12	66.5	80	85	10	*1
13	18.5	21.5	13	66.5	80	100	10	*2
14	19.8	21.5	14	66.5	80	110	10	*2
15	21	21.5	15	65.5	80	120	10	*2
16	22.3	21.5	16	65.5	80	130	10	*2
17	23.5	21.5	17	65.5	80	136	10	*2
18	24.8	21.5	18	64.5	80	145	10	*2
19	26	21.5	19	64.5	80	155	10	*2
20	27.3	21.5	20	64.5	80	170	10	*2
21	28.5	21.5	21	64.5	80	181	10	*2
22	29.8	21.5	22	63.5	80	190	10	*2
24	32.3	21.5	24	63.5	80	216	10	*2

## 13301M / 13301A

6-point Deep Socket, Thin Walled  
6-kant Steckschlüssel, dünnwandig  
Douilles à paroi mince longues, 6-pans

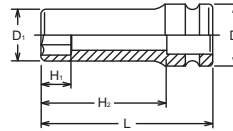

13301A (inch)	D <sub>1</sub> (mm)	D <sub>2</sub> (mm)	H <sub>1</sub> (mm)	H <sub>2</sub> (mm)	L (mm)	(g)	(pcs.)	
1/4	10	18.5	6	66.5	80	65	10	*1
5/16	12.3	18.5	8	66.5	80	68	10	*1
3/8	14.8	18.5	10	66.5	80	72	10	*1
7/16	16	18.5	11	66.5	80	80	10	*1
1/2	18.5	21.5	13	66.5	80	100	10	*2
9/16	19.8	21.5	14	66.5	80	110	10	*2
5/8	22.3	21.5	16	65.5	80	130	10	*2
11/16	23.5	21.5	17	65.5	80	136	10	*2
3/4	26	21.5	19	64.5	80	155	10	*2
13/16	28.5	21.5	21	64.5	80	181	10	*2
7/8	29.8	21.5	22	63.5	80	190	10	*2

\*1 C-Ring=1301C, Pin/O-Ring=1301A/B  
\*2 C-Ring=1302C, Pin/O-Ring=1302A/B

→ P254-255

13305M (mm)	D <sub>1</sub> (mm)	D <sub>2</sub> (mm)	H <sub>1</sub> (mm)	H <sub>2</sub> (mm)	L (mm)	(g)	(pcs.)	
8	13.3	19	8	66.5	80	82	10	*1
10	15.8	19	10	66.5	80	94	10	*1
11	17	19	11	66.5	80	110	10	*1
12	18.3	19	12	66.5	80	111	10	*1
13	19.5	22	13	66.5	80	138	10	*2
14	20.8	22	14	66.5	80	148	10	*2
17	24.5	22	17	65.5	80	168	10	*2

\*1 C-Ring=1301C, Pin/O-Ring=1301A/B  
\*2 C-Ring=1302C, Pin/O-Ring=1302A/B

→ P254-255

## 13305M

12-point Sockets, deep  
12-kant Steckschlüssel, lang  
Douilles longues, 12-pans

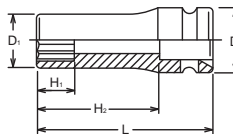

13306M (mm)	D <sub>1</sub> (mm)	D <sub>2</sub> (mm)	H <sub>1</sub> (mm)	H <sub>2</sub> (mm)	L (mm)	(g)	(pcs.)	
8	12.3	18.5	8	66.5	80	68	10	*1
10	14.8	18.5	10	66.5	80	72	10	*1
11	16	18.5	11	66.5	80	80	10	*1
12	17.3	18.5	12	66.5	80	85	10	*1
13	18.5	21.5	13	66.5	80	100	10	*2
14	19.8	21.5	14	66.5	80	110	10	*2
17	23.5	21.5	17	66.5	80	136	10	*2

\*1 C-Ring=1301C, Pin/O-Ring=1301A/B  
\*2 C-Ring=1302C, Pin/O-Ring=1302A/B

→ P254-255

## 13306M

12-point Deep Sockets, Thin Walled  
12-kant Steckschlüssel, dünnwandig  
Douilles à paroi mince longues, 12-pans

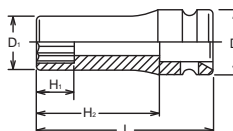

# Impact Sockets

## Impact Steckschlüssel

### Douilles Impact

# 3/8"

Z-SERIES  
HAND  
TITANIUM  
SCREWDRIVERS ACCESSORIES  
IMPACT  
SLEEVE-DRIVE  
PROTECTOR  
INDUSTRIAL  
AUTOMOTIVE  
MOTORCYCLE  
CONSTRUCTION  
SPARE PART

### 13300G

Impact Socket with Sliding Magnet  
Impact Steckschlüssel mit versenkbarem Magnet  
Douilles Impact avec aimant, glissant pour écrous

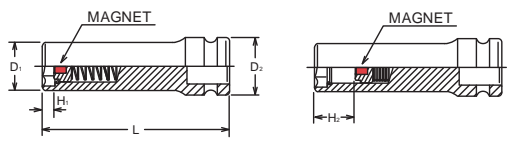

13300G (mm)	D <sub>1</sub> (mm)	D <sub>2</sub> (mm)	H <sub>1</sub> (mm)	H <sub>2</sub> (mm)	L (mm)	(g)	(pcs.)	
8	13.3	19	4	26.5	80	82	10	*1
10	15.8	19	4.5	26	80	105	10	*1
12	18.3	19	6	26	80	136	10	*1
13	19.5	22	6.5	25	80	165	10	*2
14	20.8	22	7	24	80	186	10	*2
15	22	22	7	24	80	195	10	*2
16	23.3	22	8	27	80	210	10	*2
17	24.5	22	8	27	80	220	10	*2
19	27	22	9	28	80	230	10	*2

\*1 C-Ring=1301C, Pin/O-Ring=1301A/B  
\*2 C-Ring=1302C, Pin/O-Ring=1302A/B → P254-255

### 13310M

Surface Drive Sockets, deep  
Surface Drive Steckschlüssel, lang  
Douilles longues, Surface Drive

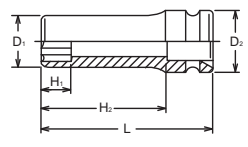

13310M (mm)	D <sub>1</sub> (mm)	D <sub>2</sub> (mm)	H <sub>1</sub> (mm)	H <sub>2</sub> (mm)	L (mm)	(g)	(pcs.)	
7	12	19	7	66.5	80	77	10	*1
8	13.3	19	8	66.5	80	90	10	*1
9	14.5	19	9	66.5	80	90	10	*1
10	15.8	19	10	66.5	80	97	10	*1
11	17	19	11	66.5	80	110	10	*1
12	18.3	19	12	66.5	80	105	10	*1
13	19.5	22	13	66.5	80	135	10	*2
14	20.8	22	14	66.5	80	145	10	*2
15	22	22	15	65.5	80	160	10	*2
16	23.3	22	16	65.5	80	156	10	*2
17	24.5	22	17	65.5	80	168	10	*2
18	25.8	22	18	64.5	80	190	10	*2
19	27	22	19	64.5	80	190	10	*2

\*1 C-Ring=1301C, Pin/O-Ring=1301A/B  
\*2 C-Ring=1302C, Pin/O-Ring=1302A/B → P254-255

### 13365M

Pathfinder Sockets, deep  
Pathfinder Steckschlüssel, lang  
Douilles longues, Pathfinder

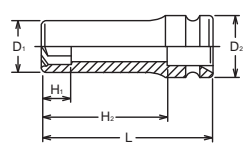

13365M (mm)	D <sub>1</sub> (mm)	D <sub>2</sub> (mm)	H <sub>1</sub> (mm)	H <sub>2</sub> (mm)	L (mm)	(g)	(pcs.)	
8	13.3	19	7	66.5	80	90	10	*1
10	15.8	19	8	66.5	80	99	10	*1
11	17	19	8	66.5	80	108	10	*1
12	18.3	19	9	66.5	80	110	10	*1
13	19.5	22	9	66.5	80	142	10	*2
14	20.8	22	11	66.5	80	144	10	*2
15	22	22	11	65.5	80	150	10	*2
16	23.3	22	11	65.5	80	159	10	*2
17	24.5	22	12	65.5	80	170	10	*2
18	25.8	22	13	64.5	80	201	10	*2
19	27	22	13	64.5	80	203	10	*2

\*1 C-Ring=1301C, Pin/O-Ring=1301A/B  
\*2 C-Ring=1302C, Pin/O-Ring=1302A/B → P254-255

### 13325

TORX® Deep Sockets  
TORX® Steckschlüssel, lang  
Douilles longues TORX®

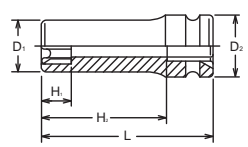

13325 (E)	D <sub>1</sub> (mm)	D <sub>2</sub> (mm)	H <sub>1</sub> (mm)	H <sub>2</sub> (mm)	L (mm)	(g)	(pcs.)	
E 7	11.2	19	6.6	66.5	80	75	10	*1
E 8	11.7	19	7	66.5	80	80	10	*1
E10	12.2	19	8.2	66.5	80	85	10	*1
E12	14.2	19	9.3	66.5	80	90	10	*1
E14	17.2	19	10.6	66.5	80	110	10	*1
E16	18.2	19	11.8	66.5	80	110	10	*1

\*1 C-Ring=1301C, Pin/O-Ring=1301A/B → P254-255

13440M (mm)	D (mm)	H (mm)	L (mm)	(g)	(pcs.)	
10	15.8	5	57	115	10	*1
11	17	6	57	115	10	*1
12	18.3	6	57	115	10	*1
13	19.5	6	57	115	10	*1
14	20.8	7	59	120	10	*1
15	22	7	59	120	10	*1
16	23.3	8	59	120	10	*1
17	24.5	8	59	120	10	*1
18	25.8	9	61	126	10	*1
19	27	10	61	130	10	*1
20	29.5	10	61	135	10	*1
21	30.7	14	66	175	10	*1
22	32	13	66	185	10	*1
24	34.5	13	68	190	10	*1

13440A (inch)	D (mm)	H (mm)	L (mm)	(g)	(pcs.)	
3/8	15.8	5	57	115	10	*1
7/16	17	6	57	115	10	*1
1/2	19.5	6	57	115	10	*1
9/16	20.8	7	59	120	10	*1
5/8	23.3	8	59	120	10	*1
11/16	24.5	8	59	120	10	*1
3/4	27	10	61	130	10	*1

\*1 C-Ring=1302C, Pin/O-Ring=1302A/B → P254-255

13440T (E)	D (mm)	H (mm)	L (mm)	(g)	(pcs.)	
E10	13.3	8.2	58	115	10	*1
E12	15.8	9.3	58	115	10	*1
E14	17	10.6	58	115	10	*1

\*1 C-Ring=1302C, Pin/O-Ring=1302A/B → P254-255

13430M (mm)	D (mm)	H (mm)	L (mm)	(g)	(pcs.)	
5	24	15	74	120	10	*1
6	24	15	74	131	10	*1
8	24	20	74	136	10	*1
10	24	20	74	141	10	*1
17	24	7	53	150	10	*1

\*1 C-Ring=1302C, Pin/O-Ring=1302A/B → P254-255

13103M (mm)	D <sub>1</sub> (mm)	D <sub>2</sub> (mm)	H (mm)	L (mm)	(g)	(pcs.)	
5(0.8)	9.5	19	8	32	39	10	*1
6(1.0)	10.8	19	9	32	41	10	*1
7(1.0)	12.5	19	10	32	44	10	*1
8(1.25)	13.5	19	10.5	35	49	10	*1
10(1.25)	15.8	19	13	35	49	10	*1
10(1.5)	15.8	19	13	35	49	10	*1

\*1 C-Ring=1301C, Pin/O-Ring=1301A/B → P254-255

⚠ Depend on the stud bolt and using torque, 4103M/13103M/14103M may cause a scratch against the stud bolts or got stuck itself during a work.

A special socket for installing a stud bolt.

Inside steel ball prevent the stud bolt stuck onto the socket. After installing a stud bolt, turn to anti-clockwise to removing the socket.

Spezialwerkzeug zum Setzen von Stehbolzen. Der Bolzen trifft im Werkzeug nur auf den Stahlbolzen, was die Kontaktfläche verringert. Nach dem Setzen des Stehbolzens kann das Werkzeug im Linkslauf vom Stehbolzen abgezogen werden.

Douilles spéciales pour monter les goujons.

Le goujon est en contact avec une bille d'acier pour l'empêcher d'adhérer à la douille. Après avoir posé le goujon, tourner dans le sens antihorlogique pour le retirer



STUD BOLT SETTER

### 13440M / 13440A

○ Universal Sockets  
Gelenk-Einsätze  
Douilles universelles

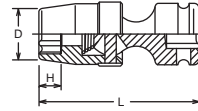

### 13440T

⊛ TORX® Universal Sockets  
TORX® Gelenk-Einsätze  
Douilles universelles TORX®

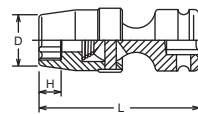

### 13430M

⊙ Universal Inhex Sockets  
Gelenk-Einsätze für Schrauben mit Innensechskant  
Douilles universelles 6-pans mâles

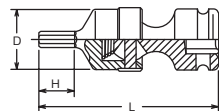

### 13103M

○ Impact Stud Bolt Setters  
Impact Stehbolzensetzer  
Monte-goujons Impact ⚠

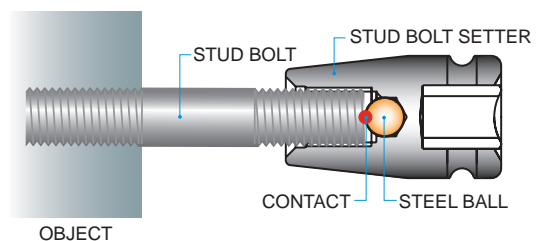
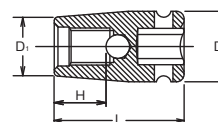

# Impact Sockets

## Impact Steckschlüssel

### Douilles Impact

# 3/8"

## 13145M-100 / -150 / -200 / -250

Extra Long Sockets  
Schafstuckschlüssel  
Douilles, série allongée

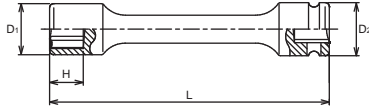

13145M-100 (mm)	D <sub>1</sub> (mm)	D <sub>2</sub> (mm)	H (mm)	L (mm)	(g)	(pce.)	
8	13.3	19	8	100	90	1	*1
10	15.8	19	10	100	92	1	*1
12	18.3	19	12	100	100	1	*1
13	19.5	19	13	100	108	1	*1
14	20.8	19	14	100	112	1	*1
17	24.5	19	17	100	140	1	*1

\*1 C-Ring=1301C, Pin/O-Ring=1301A/B → P254-255

13145M-150 (mm)	D <sub>1</sub> (mm)	D <sub>2</sub> (mm)	H (mm)	L (mm)	(g)	(pce.)	
6	10.8	19	6	150	105	1	*1
8	13.3	19	8	150	110	1	*1
10	15.8	19	10	150	120	1	*1
12	18.3	19	12	150	128	1	*1
13	19.5	19	13	150	137	1	*1
14	20.8	19	14	150	146	1	*1
15	22	19	15	150	155	1	*1
17	24.5	19	17	150	163	1	*1

13145M-200 (mm)	D <sub>1</sub> (mm)	D <sub>2</sub> (mm)	H (mm)	L (mm)	(g)	(pce.)	
6	10.8	19	6	200	136	1	*1
8	13.3	19	8	200	141	1	*1
10	15.8	19	10	200	151	1	*1
12	18.3	19	12	200	159	1	*1
13	19.5	19	13	200	168	1	*1
14	20.8	19	14	200	177	1	*1
15	22	19	15	200	186	1	*1
17	24.5	19	17	200	194	1	*1

13145M-250 (mm)	D <sub>1</sub> (mm)	D <sub>2</sub> (mm)	H (mm)	L (mm)	(g)	(pce.)	
6	10.8	19	6	250	167	1	*1
8	13.3	19	8	250	172	1	*1
10	15.8	19	10	250	182	1	*1
12	18.3	19	12	250	190	1	*1
13	19.5	19	13	250	199	1	*1
14	20.8	19	14	250	208	1	*1
15	22	19	15	250	217	1	*1
17	24.5	19	17	250	225	1	*1

\*1 C-Ring=1301C, Pin/O-Ring=1301A/B → P254-255

## 13145MG-100 / -150 / -200

Extra Long Socket with Magnet  
Schafstuckschlüssel mit Magnet  
Douilles, série allongée, avec aimant

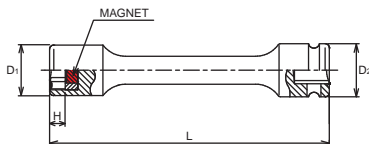

13145MG-100 (mm)	D <sub>1</sub> (mm)	D <sub>2</sub> (mm)	H (mm)	L (mm)	(g)	(pce.)	
8	13.3	19	3.5	100	90	1	*1
10	15.8	19	4.2	100	93	1	*1
12	18.3	19	5.6	100	105	1	*1
13	19.5	19	6	100	115	1	*1
14	20.8	19	6.4	100	120	1	*1

13145MG-150 (mm)	D <sub>1</sub> (mm)	D <sub>2</sub> (mm)	H (mm)	L (mm)	(g)	(pce.)	
10	15.8	19	4.2	150	125	1	*1
12	18.3	19	5.6	150	136	1	*1
13	19.5	19	6	150	145	1	*1
14	20.8	19	6.4	150	150	1	*1

13145MG-200 (mm)	D <sub>1</sub> (mm)	D <sub>2</sub> (mm)	H (mm)	L (mm)	(g)	(pce.)	
10	15.8	19	4.2	200	182	1	*1
12	18.3	19	5.6	200	190	1	*1
13	19.5	19	6	200	208	1	*1
14	20.8	19	6.4	200	225	1	*1

\*1 C-Ring=1301C, Pin/O-Ring=1301A/B → P254-255

## 13145M-100 (12P) / -150 (12P) / -200 (12P)

Extra long 12-Point Sockets  
Extra lange 12-kant Steckschlüssel  
Douilles, série allongée 12 pans

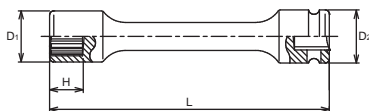

13145M-100 (12P) (mm)	D <sub>1</sub> (mm)	D <sub>2</sub> (mm)	H (mm)	L (mm)	(g)	(pce.)	
10	15.8	19	10	100	91	1	*1
12	18.3	19	12	100	100	1	*1

13145M-150 (12P) (mm)	D <sub>1</sub> (mm)	D <sub>2</sub> (mm)	H (mm)	L (mm)	(g)	(pce.)	
10	15.8	19	10	150	120	1	*1
12	18.3	19	12	150	128	1	*1

13145M-200 (12P) (mm)	D <sub>1</sub> (mm)	D <sub>2</sub> (mm)	H (mm)	L (mm)	(g)	(pce.)	
10	15.8	19	10	200	151	1	*1
12	18.3	19	12	200	159	1	*1

\*1 C-Ring=1301C, Pin/O-Ring=1301A/B → P254-255



13146M-150 (mm)	D <sub>1</sub> (mm)	D <sub>2</sub> (mm)	H (mm)	L (mm)	(g)	(pce.)	
8	12	19	6	150	128	1	*1
10	14.3	19	7	150	131	1	*1
12	18	19	8	150	133	1	*1
13	19.3	19	8.5	150	132	1	*1
14	20	19	9	150	132	1	*1

13146M-200 (mm)	D <sub>1</sub> (mm)	D <sub>2</sub> (mm)	H (mm)	L (mm)	(g)	(pce.)	
8	12	19	6	200	159	1	*1
10	14.3	19	7	200	162	1	*1
12	18	19	8	200	164	1	*1
13	19.3	19	8.5	200	163	1	*1
14	20	19	9	200	163	1	*1

13146M-250 (mm)	D <sub>1</sub> (mm)	D <sub>2</sub> (mm)	H (mm)	L (mm)	(g)	(pce.)	
8	12	19	6	250	190	1	*1
10	14.3	19	7	250	193	1	*1
12	18	19	8	250	195	1	*1
13	19.3	19	8.5	250	194	1	*1
14	20	19	9	250	194	1	*1

\*1 C-Ring=1301C, Pin/O-Ring=1301A/B → P254-255

## 13146M-150 / -200 / -250

○ Extra Long Universal Sockets  
Schäftsteckschlüssel mit Gelenk  
Douilles, articulées, série allongée

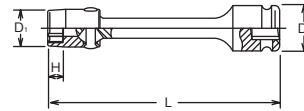

13147M-150 (mm)	D <sub>1</sub> (mm)	D <sub>2</sub> (mm)	H (mm)	L (mm)	(g)	(pce.)	
4	21	19	15	150	125	1	*1
5	21	19	15	150	128	1	*1
6	21	19	15	150	132	1	*1
8	21	19	15	150	136	1	*1
10	21	19	15	150	140	1	*1

13147M-200 (mm)	D <sub>1</sub> (mm)	D <sub>2</sub> (mm)	H (mm)	L (mm)	(g)	(pce.)	
4	21	19	15	200	156	1	*1
5	21	19	15	200	159	1	*1
6	21	19	15	200	163	1	*1
8	21	19	15	200	167	1	*1
10	21	19	15	200	171	1	*1

\*1 C-Ring=1301C, Pin/O-Ring=1301A/B → P254-255

## 13147M-150 / -200

● Extra Long Universal Inhex Sockets  
Schäftsteckschlüssel mit Aussensechskant Gelenk  
Douilles, articulées, à 6-pans mâle, série allongée

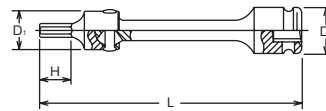

# Impact Sockets Impact Steckschlüssel Douilles Impact

# 3/8"

Z-SERIES  
HAND  
TITANIUM  
SCREWDRIVERS ACCESSORIES  
IMPACT  
SLEEVE-DRIVE  
PROTECTOR  
INDUSTRIAL  
AUTOMOTIVE  
MOTORCYCLE  
CONSTRUCTION  
SPARE PART

## 13012M-52

 Inhex Sockets  
Steckschlüssel für Innensechskant-Schrauben  
Douilles tournevis pour vis 6-pans creux

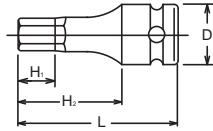

13012M-52 (mm)	D (mm)	H <sub>1</sub> (mm)	H <sub>2</sub> (mm)	L (mm)	(g)	(pcs.)	(V)
3	18	10	34	52	33	10	*1
4	18	15.5	34	52	35	10	*1
5	18	15.5	34	52	35	10	*1
6	18	15.5	34	52	39	10	*1
7	18	15.5	34	52	44	10	*1
8	21	15.5	34	52	60	10	*2
10	21	15.5	34	52	70	10	*2
12	21	15.5	34	52	79	10	*2
14	21	15.5	34	52	92	10	*2

\*1 C-Ring=1301C, Pin/O-Ring=1301A/B  
\*2 C-Ring=1302C, Pin/O-Ring=1302A/B **→ P254-255**

## RS13012M/8-L52

 Socket Set on Rail  
Steckschlüsselsatz auf Schiene  
Jeu de douilles sur rail



RS13012M/8-L52	8 Pieces Set/Rail 200mm	(g)
4, 5, 6, 7, 8, 10, 12, 14		492

## 13025-50 / -90

 TORX® Bit Sockets  
TORX® Bit-Steckschlüssel  
Douilles tournevis, TORX®

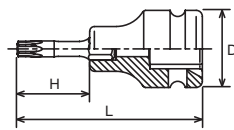

13025-50 (T)	D (mm)	H (mm)	L (mm)	(g)	(pcs.)	(V)
T20	19	23.5	50	35	10	*1
T25	19	23.5	50	35	10	*1
T27	19	23.5	50	35	10	*1
T30	19	23.5	50	35	10	*1
T40	19	23.5	50	39	10	*1
T45	19	23.5	50	60	10	*1
T50	19	23.5	50	70	10	*1
T55	22	23.5	50	79	10	*2

13025-90 (T)	D (mm)	H (mm)	L (mm)	(g)	(pcs.)	(V)
T20	19	63.5	90	43	10	*1
T25	19	63.5	90	45	10	*1
T27	19	63.5	90	47	10	*1
T30	19	63.5	90	50	10	*1
T40	19	63.5	90	58	10	*1
T45	19	63.5	90	66	10	*1
T50	19	63.5	90	80	10	*1
T55	22	63.5	90	120	10	*2

\*1 C-Ring=1301C, Pin/O-Ring=1301A/B  
\*2 C-Ring=1302C, Pin/O-Ring=1302A/B **→ P254-255**

## RS13025/8-L50

 Socket Set on Rail  
Steckschlüsselsatz auf Schiene  
Jeu de douilles sur rail



RS13025/8-L50	8 Pieces Set/Rail 200mm	(g)
T20, T25, T27, T30, T40, T45, T50, T55		380

	D (mm)	L (mm)	(g)	(pcs.)	
<b>13134</b>	22	32	70	10	*2

\*2 C-Ring=1302C, Pin/O-Ring=1302A/B → P254-255

For DIN3126 E11.2 Bits  
Für DIN3126 E11.2 Bits  
Pour DIN3126 E11.2 Embouts

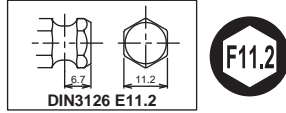

13134-SC

Replacement Screw : M8x5, ● 4mm  
Ersatzschraube : M8x5, ● 4mm  
Vis de remplacement : M8x5, ● 4mm

	D <sub>1</sub> (mm)	D <sub>2</sub> (mm)	L (mm)	(g)	(pcs.)	
<b>13142-F11.2</b>	18.9	22	46	116	10	*2

\*2 C-Ring=1302C, Pin/O-Ring=1302A/B → P254-255

For DIN3126 E11.2 Bits  
Für DIN3126 E11.2 Bits  
Pour DIN3126 E11.2 Embouts

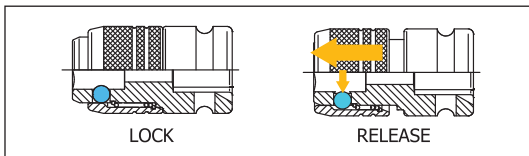
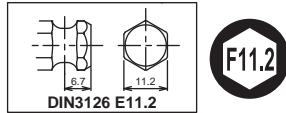

⚠ You may not hold the sliding part while moving to avoid heating up by friction and reduction by wear.

183H-35 (inch)	L (mm)	(g)	(pcs.)
3/16	35	15	10
7/32	35	16	10
1/4	35	18	10
5/16	35	20	10
3/8	35	26	10
7/16	35	28	10
1/2	35	38	10

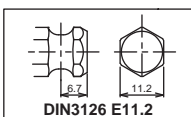

### 13134 ○ Impact Bit Holder Impact Klingenhalter Porte embouts Impact

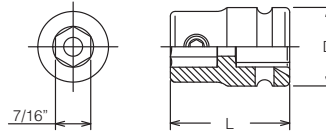

### 13142-F11.2 ○ Impact Bit Holder (Quick Release) Impact Klingenhalter (Quick Release) Porte embouts Impact (Quick Release) ⚠

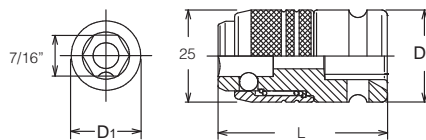

### 183H-35 / -75 / -150 ● Hex Bits Sechskant Bits Embouts, 6 pans creux

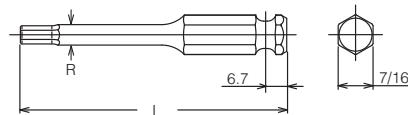

183H-35 (mm)	L (mm)	(g)	(pcs.)
3	35	15	10
4	35	15	10
5	35	15	10
6	35	18	10
7	35	19	10
8	35	20	10
New 9	35	23	10
10	35	26	10
11	35	28	10
12	35	30	10
14	35	35	10
16	35	47	10
17	35	50	10
18	35	53	10
19	35	56	10

183H-75 (mm)	L (mm)	R (mm)	(g)	(pcs.)
3	75	6	34	10
4	75	6	35	10
5	75	6.5	36	10
6	75	7.5	39	10
7	75	8.5	44	10
8	75	9.5	47	10
10	75	-	57	10
11	75	-	60	10
12	75	-	65	10
14	75	-	79	10

183H-150 (mm)	L (mm)	R (mm)	(g)	(pcs.)
4	150	6	51	10
5	150	6.5	55	10
6	150	7.5	65	10
8	150	9.5	87	10
10	150	-	118	10
12	150	-	136	10

Z-SERIES  
HAND  
TITANIUM  
SCREWDRIVERS ACCESSORIES  
IMPACT  
SLEEVE-DRIVE  
PROTECTOR  
INDUSTRIAL  
AUTOMOTIVE  
MOTORCYCLE  
CONSTRUCTION  
SPARE PART

## 183T-35 / -75 / -150 (T)

 TORX® Bits  
TORX® Bits  
Embouts, TORX®

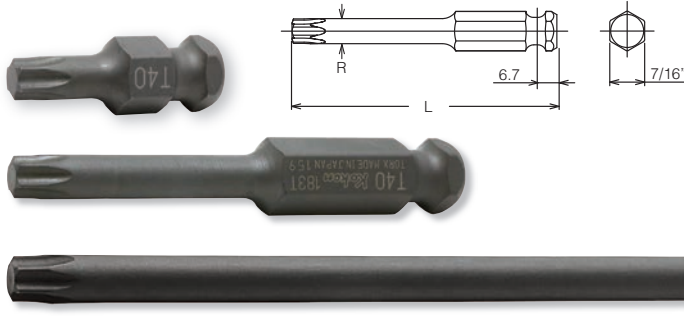

183T-35 (T)	L (mm)	(g)	(pcs.)
T25	35	18	10
T30	35	18	10
T40	35	20	10
T45	35	22	10
T50	35	26	10
T55	35	30	10
T60	35	38	10

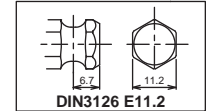

183T-150 (T)	L (mm)	R (mm)	(g)	(pcs.)
T30	150	6	50	10
T40	150	6.9	58	10
T45	150	8	70	10
T50	150	9	82	10
T55	150	11.4	113	10

183T-75 (T)	L (mm)	R (mm)	(g)	(pcs.)
T30	75	6	35	10
T40	75	6.9	37	10
T45	75	8	41	10
T50	75	9	45	10
T55	75	11.4	55	10
T60	75	13.5	67	10

## 183T-35 / -75 (IP)

 TORXPLUS® Bits  
TORXPLUS® Bits  
Embouts TORXPLUS®

**TORXplus**

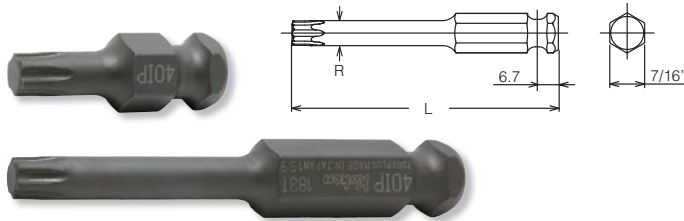

183T-35 (IP)	L (mm)	(g)	(pcs.)
30IP	35	18	10
40IP	35	20	10
45IP	35	22	10
50IP	35	26	10
55IP	35	30	10
60IP	35	38	10

183T-75 (IP)	L (mm)	R (mm)	(g)	(pcs.)
30IP	75	6	35	10
40IP	75	6.8	37	10
45IP	75	8	41	10
50IP	75	9	45	10
55IP	75	11.4	56	10
60IP	75	13.5	67	10

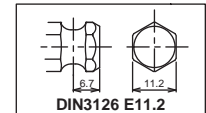

## 183X-35 / -75 / -150 (XZN)

 XZN Bits  
XZN Bits  
Embouts, XZN

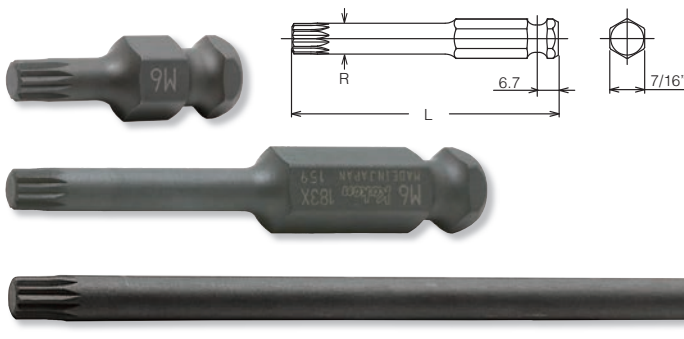

183X-35 (XZN)	L (mm)	(g)	(pcs.)
M 4	35	18	10
M 5	35	18	10
M 6	35	20	10
M 8	35	22	10
M10	35	26	10
M12	35	30	10
M14	35	38	10

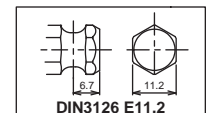

183X-75 (XZN)	L (mm)	R (mm)	(g)	(pcs.)
M 4	75	6	34	10
M 5	75	6	34	10
M 6	75	6.2	36	10
M 8	75	7.4	39	10
M10	75	9.8	54	10
M12	75	11.7	57	10
M14	75	13.5	67	10

183X-150 (XZN)	L (mm)	R (mm)	(g)	(pcs.)
M 5	150	6	50	10
M 6	150	6.2	53	10
M 8	150	7.4	64	10
M10	150	9.8	93	10
M12	150	11.7	121	10

13134M-52/-92 (mm)	D (mm)	H (mm)	L (mm)	L (mm)	R (mm)	L=52 (g)	L=92 (g)	L=52/92 (pcs.)	⊕
3	22	20.6	52	92	6	85	104	10	*2
4	22	20.6	52	92	6	85	105	10	*2
5	22	20.6	52	92	6.5	85	106	10	*2
6	22	20.6	52	92	7.5	88	109	10	*2
8	22	20.6	52	92	9.5	90	117	10	*2
10	22	20.6	52	92	-	96	127	10	*2
12	22	20.6	52	92	-	100	135	10	*2
14	22	20.6	52	92	-	105	149	10	*2

\*2 C-Ring=1302C, Pin/O-Ring=1302A/B → P254-255

## 13134M-52 / -92

Bit Holder complete with Bit, Inhex  
Klingenhälter komplett mit Klinge, Innensechskant  
Porte embouts avec bit 6-pans creux

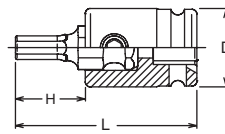

13134T-52/-92 (T)	D (mm)	H (mm)	L (mm)	L (mm)	R (mm)	L=52 (g)	L=92 (g)	L=52/92 (pcs.)	⊕
T30	22	20.6	52	92	6	88	105	10	*2
T40	22	20.6	52	92	6.9	90	107	10	*2
T45	22	20.6	52	92	8	92	111	10	*2
T50	22	20.6	52	92	9	96	115	10	*2
T55	22	20.6	52	92	11.4	100	125	10	*2
T60	22	20.6	52	92	13.5	108	137	10	*2

\*2 C-Ring=1302C, Pin/O-Ring=1302A/B → P254-255

## 13134T-52 / -92 (T)

Bit Holder complete with TORX® Bit  
Klingenhälter, komplett mit TORX® Klinge  
Porte embouts avec bit TORX®

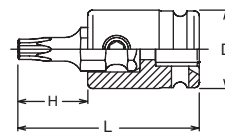

13134T-52/-92 (IP)	D (mm)	H (mm)	L (mm)	L (mm)	R (mm)	L=52 (g)	L=92 (g)	L=52/92 (pcs.)	⊕
30IP	22	20.6	52	92	6	88	105	10	*2
40IP	22	20.6	52	92	6.8	90	107	10	*2
45IP	22	20.6	52	92	8	92	111	10	*2
50IP	22	20.6	52	92	9	96	115	10	*2
55IP	22	20.6	52	92	11.4	100	126	10	*2
60IP	22	20.6	52	92	13.5	108	139	10	*2

\*2 C-Ring=1302C, Pin/O-Ring=1302A/B → P254-255

## 13134T-52 / -92 (IP)

Bit Holder complete with TORXPLUS® Bit  
Klingenhälter, komplett mit TORXPLUS® Klinge  
Porte embouts avec bit TORXPLUS®

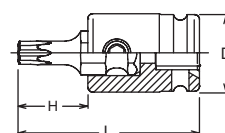

13134X-52/-92 (XZN)	D (mm)	H (mm)	L (mm)	L (mm)	R (mm)	L=52 (g)	L=92 (g)	L=52/92 (pcs.)	⊕
M 5	22	20.6	52	92	6	88	104	10	*2
M 6	22	20.6	52	92	6.2	90	106	10	*2
M 8	22	20.6	52	92	7.4	92	109	10	*2
M10	22	20.6	52	92	9.8	96	124	10	*2
M12	22	20.6	52	92	11.7	100	129	10	*2
M14	22	20.6	52	92	13.5	108	139	10	*2

\*2 C-Ring=1302C, Pin/O-Ring=1302A/B → P254-255

## 13134X-52 / -92 (XZN)

Bit Holder complete with XZN Bit  
Klingenhälter, komplett mit XZN Klinge  
Porte embouts avec bit XZN

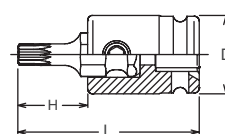

# Impact Sockets Impact Steckschlüssel Douilles Impact

# 3/8"

Z-SERIES  
HAND  
TITANIUM  
SCREWDRIVERS ACCESSORIES  
IMPACT  
SLEEVE-DRIVE  
PROTECTOR  
INDUSTRIAL  
AUTOMOTIVE  
MOTORCYCLE  
CONSTRUCTION  
SPARE PART

## 13139 ○ Bit Holder Klingenhalter Porte-embout

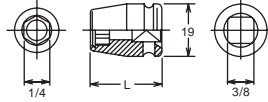

	D <sub>1</sub> (mm)	D <sub>2</sub> (mm)	L (mm)	(g)	(pcs.)	⚡
<b>13139-1/4</b>	11	19	30	32	10	*1

\*1 C-Ring=1301C, Pin/O-Ring=1301A/B → P254-255

For DIN3126 C6.3 Bits  
Für DIN3126 C6.3 Bits  
Pour DIN3126 C6.3 Embouts

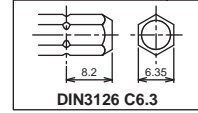

## 13140 ○ Bit Holder Klingenhalter Porte-embout

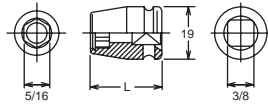

	D <sub>1</sub> (mm)	D <sub>2</sub> (mm)	L (mm)	(g)	(pcs.)	⚡
<b>13140-5/16</b>	14	19	30	32	10	*1

\*1 C-Ring=1301C, Pin/O-Ring=1301A/B → P254-255

For DIN3126 C8 Bits  
Für DIN3126 C8 Bits  
Pour DIN3126 C8 Embouts

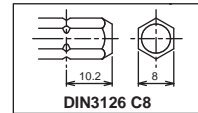

## 13142-D6.3 ○ Impact Bit Holder (Quick Release) Impact Kingenhalter (Schnellwechselfutter) Porte embout Impact (mandrin autoserrant) ⚠

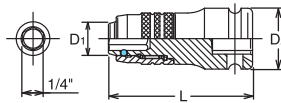

	D <sub>1</sub> (mm)	D <sub>2</sub> (mm)	L (mm)	(g)	(pcs.)	⚡
<b>13142-D6.3</b>	16	19	45	60	10	*1

\*1 C-Ring=1301C, Pin/O-Ring=1301A/B → P254-255

For DIN3126 C6.3 Bits  
Für DIN3126 C6.3 Bits  
Pour DIN3126 C6.3 Embouts

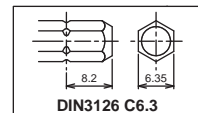

⚠ You may not hold the sliding part while moving to avoid heating up by friction and reduction by wear.

## 13142-F6.3 ○ Impact Bit Holder (Quick Release) Impact Kingenhalter (Schnellwechselfutter) Porte embout Impact (mandrin autoserrant) ⚠

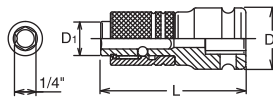

	D <sub>1</sub> (mm)	D <sub>2</sub> (mm)	L (mm)	(g)	(pcs.)	⚡
<b>13142-F6.3</b>	16.5	19	45	60	10	*1

\*1 C-Ring=1301C, Pin/O-Ring=1301A/B → P254-255

For DIN3126 E6.3 Bits  
Für DIN3126 E6.3 Bits  
Pour DIN3126 E6.3 Embouts

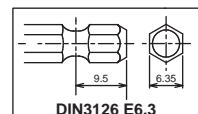

### Lock & Quick Release

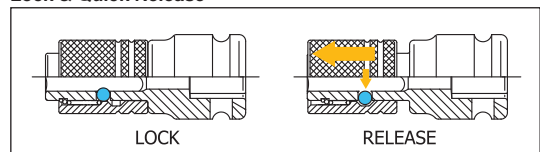

⚠ You may not hold the sliding part while moving to avoid heating up by friction and reduction by wear.

	TYPE	D (mm)	L (mm)	(g)	(pcs.)	⚡
13760-50P	Pin	22	50	70	10	*2
13760-50	Hole	22	50	70	10	*2
13760-75P	Pin	22	75	95	10	*2
13760-75	Hole	22	75	95	10	*2
13760-100P	Pin	22	100	115	10	*2
13760-100	Hole	22	100	115	10	*2
13760-125P	Pin	22	125	140	5	*2
13760-125	Hole	22	125	140	5	*2
13760-150P	Pin	22	150	165	5	*2
13760-150	Hole	22	150	165	5	*2
13760-200P	Pin	22	200	215	5	*2
13760-200	Hole	22	200	215	5	*2
13760-250P	Pin	22	250	260	5	*2
13760-250	Hole	22	250	260	5	*2

\*2 C-Ring=1302C, Pin/O-Ring=1302A/B → P254-255

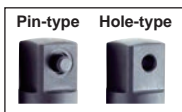

## 13760-P 13760

Extension Bars  
Verlängerungen  
Rallonges



	L (mm)	(g)	(pcs.)	⚡
13333AL	45	62	10	*1

\*1 C-Ring=1301C, Pin/O-Ring=1301A/B → P254-255

### Lock & Quick Release

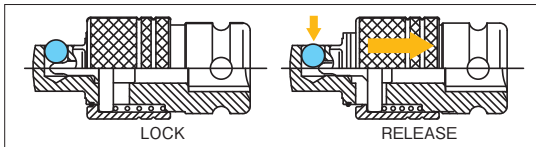

⚠ You may not hold the sliding part while moving to avoid heating up by friction and reduction by wear.



## 13333AL

Adaptor (Quick Release)  
Verbindungsstück (Quick Release) ⚠  
Adaptateur (Quick Release)

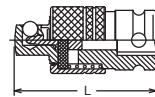

Impact Sockets  
Impact Steckschlüssel  
Douilles Impact

3/8"

Z-SERIES  
HAND  
TITANIUM  
SCREWDRIVERS ACCESSORIES  
IMPACT  
SLEEVE-DRIVE  
PROTECTOR  
INDUSTRIAL  
AUTOMOTIVE  
CONSTRUCTION MOTORCYCLE  
SPARE PART

**13770-P** Universal Joint  
Gelenk-Einsatz  
Joint articulé  
**13770**

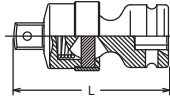
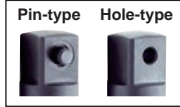

	TYPE	L (mm)	(g)	(pcs.)	(V)
<b>13770-P</b>	Pin	56	110	10	*2
<b>13770</b>	Hole	56	110	10	*2
<b>13771-P</b>	Pin	48	92	10	*2
<b>13771</b>	Hole	48	92	10	*2

\*2 C-Ring=1302C, Pin/O-Ring=1302A/B → P254-255

Our ball joints are spring-loaded and can therefore be adjusted to an angle of max. 30°.

Unsere Kugelgelenke sind federbelastet dadurch sind sie auf einen Winkel von max 30° einstellbar.

Nos joints à rotule sont à ressort et peuvent donc être réglés jusqu'à un angle de 30° maximum.

**13771-P** Universal Joint  
Gelenk-Einsatz  
Joint articulé  
**13771**

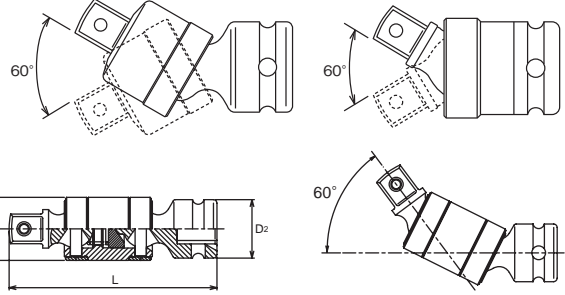
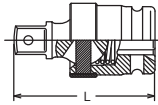

**13772-P** Universal Double Joint  
Doppelgelenk-Einsatz  
Joint articulé double



	D <sub>1</sub> (mm)	D <sub>2</sub> (mm)	L (mm)	(g)	(pcs.)	(V)
<b>13772-P</b>	22	19	75	120	5	*1

\*1 C-Ring=1301C, Pin/O-Ring=1301A/B → P254-255

Make sure sockets hold bolts or nuts before operation.

Vergewissern Sie sich vor dem Gebrauch, dass der Steckschlüssel die Schraube sicher umfasst hat.

Avant la manipulation, il est nécessaire de s'assurer que la douille renferme parfaitement la vis.

⚠ 13772 and 14772 have less load capacity than standard. In the interest of your safety always use properly.

**13322A-P** Adaptor  
Verbindungsstück  
Réducteur  
**13322A**

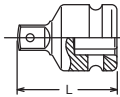

	TYPE	(sq.)	(sq.)	L (mm)	(g)	(pcs.)	(V)
<b>13322A-P</b>	Pin	3/8"	1/4"	27	25	10	*1
<b>13322A</b>	Hole	3/8"	1/4"	27	25	10	*1

\*1 C-Ring=1301C, Pin/O-Ring=1301A/B → P254-255

⚠ Adapting down from bigger square drive to smaller square drive may lead to excessive torque load and possibly cause breakage. Always stay within safe torque of the smaller square drive.

Die mit ⚠ gekennzeichneten Artikel können bei Überbelastung zu Bruch gehen. Aus Gründen Ihrer eigenen Sicherheit sollten die betreffenden Werkzeuge nie ruckartig, sondern nach und nach belastet werden, um Bruch und damit verbundene mögliche Verletzungen zu vermeiden.

Il est possible d'appliquer aux articles marqués ⚠ des couples de serrage susceptibles d'occasionner leur rupture. Pour votre propre sécurité, veuillez toujours appliquer la charge d'une manière uniforme et progressive. Ceci pour éviter ruptures et accidents.

**13344A-P** Adaptor  
Verbindungsstück  
Augmentateur  
**13344A**

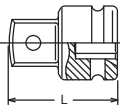

	TYPE	(sq.)	(sq.)	L (mm)	(g)	(pcs.)	(V)
<b>13344A-P</b>	Pin	3/8"	1/2"	32.5	53	10	*2
<b>13344A</b>	Hole	3/8"	1/2"	32.5	53	10	*2

\*2 C-Ring=1302C, Pin/O-Ring=1302A/B → P254-255

**13241M** Socket Set  
Steckschlüssel Satz  
Jeu de clés à douilles



**13241M** 11 Pieces Set/⚖=850g

METAL CASE:W240xH30xT35mm

Sockets

13400M 6-pt. Sockets  
9, 10, 11, 12, 13, 14, 15, 16, 17, 18, 19

**13242M** Socket Set  
Steckschlüssel Satz  
Jeu de clés à douilles



**13242M** 11 Pieces Set/⚖=1,140g

METAL CASE:W310xH90xT48mm

Sockets

13400M 6-pt. Sockets  
9, 10, 11, 12, 13, 14, 15, 16, 17, 18, 19



# 1/2"

## Impact Sockets Impact Steckschlüssel Douilles Impact

14400M (mm)	D <sub>1</sub> (mm)	D <sub>2</sub> (mm)	H (mm)	L (mm)	⚖ (g)	📦 (pcs.)	⚙
8	14.5	25	6	38	85	10	*1
9	15.7	25	7	38	85	10	*1
10	17	25	7	38	85	10	*1
11	18.2	25	8	38	85	10	*1
12	19.5	25	9	38	85	10	*1
13	20.7	25	10	38	85	10	*1
14	22	25	10	38	85	10	*1
15	23.2	30	11	38	130	10	*2
16	24.5	30	11	38	130	10	*2
17	25.7	30	12	38	130	10	*2
18	27	30	13	38	130	10	*2
19	28.2	30	13	38	125	10	*2
20	29.5	30	13	38	127	10	*2
21	30.7	30	14	38	120	10	*2
22	32	30	14	38	130	10	*2
23	33.2	30	14	38	130	10	*2
24	34.5	30	14	38	135	10	*2
25	35.7	30	14	38	135	10	*2
26	37	30	14	38	160	10	*2
27	38.2	30	16	40	160	10	*2
28	39.5	30	16	40	170	10	*2
29	40.7	30	17	42	190	10	*2
30	42	30	17	42	190	10	*2
31	43.2	30	17	42	213	10	*2
32	44.5	30	18	42	216	10	*2
33	45.7	30	19	46	260	5	*2
34	47	30	19	46	263	5	*2
35	48.2	30	19	46	275	5	*2
36	49.5	30	20	46	285	5	*2
38	52	30	20	53	360	5	*2
41	55.7	30	21	55	411	2	*2

\*1 C-Ring=1401C, Pin/O-Ring=1401A/B  
 \*2 C-Ring=1402C, Pin/O-Ring=1402A/B

➔ P254-255



### 14400M / 14400A

6-point Sockets  
6-kant Steckschlüssel  
Douilles 6-pans

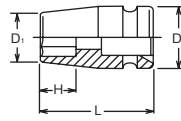

14400A (inch)	D <sub>1</sub> (mm)	D <sub>2</sub> (mm)	H (mm)	L (mm)	⚖ (g)	📦 (pcs.)	⚙
1/4	12	25	5	38	80	10	*1
5/16	14.5	25	6	38	85	10	*1
3/8	17	25	7	38	85	10	*1
7/16	18.2	25	8	38	85	10	*1
1/2	20.7	25	10	38	85	10	*1
9/16	22	25	10	38	85	10	*1
19/32	23.2	30	11	38	130	10	*2
5/8	24.5	30	11	38	130	10	*2
11/16	25.7	30	12	38	130	10	*2
3/4	28.2	30	13	38	125	10	*2
13/16	30.7	30	14	38	120	10	*2
7/8	32	30	14	38	130	10	*2
15/16	34.5	30	14	38	135	10	*2
1	35.7	30	14	38	135	10	*2
1. 1/16	38.2	30	16	40	160	10	*2
1. 1/8	40.7	30	17	42	190	10	*2
1. 3/16	42	30	17	42	190	10	*2
1. 1/4	44.5	30	18	42	216	10	*2
1. 5/16	45.7	30	19	46	260	5	*2
1. 3/8	47	30	19	46	263	5	*2
1. 1/2	52	30	20	53	365	5	*2

\*1 C-Ring=1401C, Pin/O-Ring=1401A/B  
 \*2 C-Ring=1402C, Pin/O-Ring=1402A/B

➔ P254-255

14405M (mm)	D <sub>1</sub> (mm)	D <sub>2</sub> (mm)	H (mm)	L (mm)	⚖ (g)	📦 (pcs.)	⚙
8	14.5	25	6	38	85	10	*1
9	15.7	25	7	38	85	10	*1
10	17	25	7	38	85	10	*1
11	18.2	25	8	38	84	10	*1
12	19.5	25	9	38	84	10	*1
13	20.7	25	10	38	84	10	*1
14	22	25	10	38	84	10	*1
15	23.2	30	11	38	130	10	*2
16	24.5	30	11	38	127	10	*2
17	25.7	30	12	38	128	10	*2
18	27	30	13	38	130	10	*2
19	28.2	30	13	38	125	10	*2
20	29.5	30	13	38	127	10	*2
21	30.7	30	14	38	120	10	*2
22	32	30	14	38	130	10	*2
23	33.2	30	14	38	132	10	*2
24	34.5	30	14	38	133	10	*2
26	37	30	14	38	147	10	*2
27	38.2	30	16	40	157	10	*2
28	39.5	30	16	40	170	10	*2
30	42	30	17	42	190	10	*2
32	44.5	30	18	42	216	10	*2
36	49.5	30	20	46	285	5	*2
41	55.7	30	21	55	411	2	*2

\*1 C-Ring=1401C, Pin/O-Ring=1401A/B  
 \*2 C-Ring=1402C, Pin/O-Ring=1402A/B

➔ P254-255

### 14405M / 14405A

12-point Sockets  
12-kant Steckschlüssel  
Douilles 12-pans

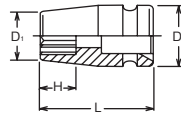

14405A (inch)	D <sub>1</sub> (mm)	D <sub>2</sub> (mm)	H (mm)	L (mm)	⚖ (g)	📦 (pcs.)	⚙
5/16	14.5	25	6	38	85	10	*1
3/8	17	25	7	38	85	10	*1
7/16	18.2	25	8	38	85	10	*1
1/2	20.7	25	10	38	85	10	*1
9/16	22	25	10	38	85	10	*1
5/8	24.5	30	11	38	130	10	*2
11/16	25.7	30	12	38	130	10	*2
3/4	28.2	30	13	38	125	10	*2
13/16	30.7	30	14	38	120	10	*2
7/8	32	30	14	38	130	10	*2
15/16	34.5	30	14	38	135	10	*2
1	35.7	30	14	38	135	10	*2
1. 1/16	38.2	30	16	40	160	10	*2
1. 1/8	40.7	30	17	42	190	10	*2
1. 3/16	42	30	17	42	190	10	*2
1. 1/4	44.5	30	18	42	216	10	*2
1. 5/16	45.7	30	19	46	260	5	*2
1. 3/8	47	30	19	46	263	5	*2
1. 1/2	52	30	20	53	365	5	*2

\*1 C-Ring=1401C, Pin/O-Ring=1401A/B  
 \*2 C-Ring=1402C, Pin/O-Ring=1402A/B

➔ P254-255

RS14405M/11	11 Pieces Set/Rail 300mm	⚖ (g)
9,10,11,12,13,14,15,16,17,18,19		1,250

### RS14405M/11

Socket Set on Rail  
Steckschlüsselsatz auf Schiene  
Jeu de douilles sur rail



Impact Sockets  
Impact Steckschlüssel  
Douilles Impact

1/2"

Z-SERIES  
HAND  
TITANIUM  
SCREWDRIVERS ACCESSORIES  
IMPACT  
SLEEVE-DRIVE  
PROTECTOR  
INDUSTRIAL  
AUTOMOTIVE  
MOTORCYCLE  
CONSTRUCTION  
SPARE PART

14401M / 14401A  6-point Sockets, Thin Walled  
6-kant Steckschlüssel, dünnwandig  
Douilles à paroi mince, 6-pans

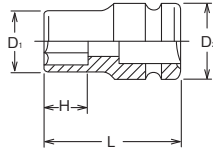

14401A (inch)	D <sub>1</sub> (mm)	D <sub>2</sub> (mm)	H (mm)	L (mm)	(g)	(pcs.)	
1/4	10.5	24	5	38	55	10	*1
5/16	13	24	6	38	57	10	*1
3/8	15.5	24	7	38	60	10	*1
7/16	16.7	24	8	38	62	10	*1
1/2	19.2	24	10	38	65	10	*1
9/16	20.5	24	10	38	67	10	*1
5/8	23	29	11	38	102	10	*2
11/16	24.2	29	12	38	105	10	*2
3/4	26.7	29	13	38	107	10	*2
13/16	29.2	29	14	38	109	10	*2
7/8	30.5	29	14	38	114	10	*2
15/16	33	29	14	38	122	10	*2
1	34.2	29	14	38	129	10	*2
1. 1/16	35.5	29	14	40	131	10	*2
1. 1/8	39.2	29	17	42	165	10	*2
1. 3/16	40.5	29	17	42	178	10	*2
1. 1/4	43	29	18	42	188	10	*2
1. 5/16	44.2	29	19	46	219	5	*2
1. 3/8	45.5	29	19	46	248	5	*2

\*1 C-Ring=1401C, Pin/O-Ring=1401A/B  
\*2 C-Ring=1402C, Pin/O-Ring=1402A/B

→ P254-255

14401M (mm)	D <sub>1</sub> (mm)	D <sub>2</sub> (mm)	H (mm)	L (mm)	(g)	(pcs.)	
8	13	24	6	38	57	10	*1
9	14.2	24	7	38	58	10	*1
10	15.5	24	7	38	60	10	*1
11	16.7	24	8	38	62	10	*1
12	18	24	9	38	63	10	*1
13	19.2	24	10	38	65	10	*1
14	20.5	24	10	38	67	10	*1
15	21.7	29	11	38	100	10	*2
16	23	29	11	38	102	10	*2
17	24.2	29	12	38	105	10	*2
18	25.5	29	13	38	105	10	*2
19	26.7	29	13	38	107	10	*2
20	28	29	13	38	108	10	*2
21	29.2	29	14	38	109	10	*2
22	30.5	29	14	38	114	10	*2
23	31.7	29	14	38	118	10	*2
24	33	29	14	38	122	10	*2
25	34.2	29	14	38	129	10	*2
26	35.5	29	14	38	131	10	*2
27	36.7	29	16	40	145	10	*2
28	38	29	16	40	152	10	*2
29	39.2	29	17	42	165	10	*2
30	40.5	29	17	42	178	10	*2
31	41.7	29	17	42	185	10	*2
32	43	29	18	42	188	10	*2
33	44.2	29	19	46	219	5	*2
34	45.5	29	19	46	248	5	*2
35	46.7	29	19	46	250	5	*2
36	48	29	20	46	264	5	*2
38	50.5	29	20	53	316	5	*2
41	54.2	29	21	55	374	2	*2

\*1 C-Ring=1401C, Pin/O-Ring=1401A/B  
\*2 C-Ring=1402C, Pin/O-Ring=1402A/B

→ P254-255

RS14401M/10   Socket Set on Rail  
Steckschlüsselsatz auf Schiene  
Jeu de douilles sur rail



RS14401M/10	10 Pieces Set/Rail 300mm	(g)
10, 12, 13, 14, 17, 19, 21, 22, 24, 27		1,010

14406M / 14406A  12-point Sockets, Thin Walled  
12-kant Steckschlüssel, dünnwandig  
Douilles à paroi mince, 12-pans

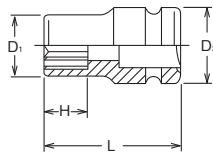

14406A (inch)	D <sub>1</sub> (mm)	D <sub>2</sub> (mm)	H (mm)	L (mm)	(g)	(pcs.)	
1/4	10.5	24	5	38	55	10	*1
5/16	13	24	6	38	57	10	*1
3/8	15.5	24	7	38	60	10	*1
7/16	16.7	24	8	38	62	10	*1
1/2	19.2	24	10	38	65	10	*1
9/16	20.5	24	10	38	67	10	*1
5/8	23	29	11	38	102	10	*2
11/16	24.2	29	12	38	105	10	*2
3/4	26.7	29	13	38	107	10	*2
13/16	29.2	29	14	38	109	10	*2
7/8	30.5	29	14	38	114	10	*2
15/16	33	29	14	38	122	10	*2
1	34.2	29	14	38	129	10	*2
1. 1/16	35.5	29	14	40	131	10	*2
1. 1/8	39.2	29	17	42	165	10	*2
1. 3/16	40.5	29	17	42	178	10	*2
1. 1/4	43	29	18	42	188	10	*2
1. 5/16	44.2	29	19	46	219	5	*2
1. 3/8	45.5	29	19	46	248	5	*2

\*1 C-Ring=1401C, Pin/O-Ring=1401A/B  
\*2 C-Ring=1402C, Pin/O-Ring=1402A/B

→ P254-255

14406M (mm)	D <sub>1</sub> (mm)	D <sub>2</sub> (mm)	H (mm)	L (mm)	(g)	(pcs.)	
8	13	24	6	38	57	10	*1
9	14.2	24	7	38	58	10	*1
10	15.5	24	7	38	60	10	*1
11	16.7	24	8	38	62	10	*1
12	18	24	9	38	63	10	*1
13	19.2	24	10	38	65	10	*1
14	20.5	24	10	38	67	10	*1
15	21.7	29	11	38	100	10	*2
16	23	29	11	38	102	10	*2
17	24.2	29	12	38	105	10	*2
18	25.5	29	13	38	105	10	*2
19	26.7	29	13	38	107	10	*2
20	28	29	13	38	108	10	*2
21	29.2	29	14	38	109	10	*2
22	30.5	29	14	38	114	10	*2
23	31.7	29	14	38	118	10	*2
24	33	29	14	38	122	10	*2
25	34.2	29	14	38	129	10	*2
26	35.5	29	14	38	131	10	*2
27	36.7	29	16	40	145	10	*2
28	38	29	16	40	152	10	*2
29	39.2	29	17	42	165	10	*2
30	40.5	29	17	42	178	10	*2
31	41.7	29	17	42	185	10	*2
32	43	29	18	42	188	10	*2
33	44.2	29	19	46	219	5	*2
34	45.5	29	19	46	248	5	*2
36	48	29	20	46	264	5	*2

\*1 C-Ring=1401C, Pin/O-Ring=1401A/B  
\*2 C-Ring=1402C, Pin/O-Ring=1402A/B

→ P254-255

# 1/2"

Impact Sockets  
Impact Steckschlüssel  
Douilles Impact

Z-SERIES  
HAND  
TITANIUM  
ACCESSORIES  
SCREWDRIVERS  
IMPACT  
SLEEVE-DRIVE  
PROTECTOR  
INDUSTRIAL  
AUTOMOTIVE  
MOTORCYCLE CONSTRUCTION  
SPARE PART

14401MS (mm)	D <sub>1</sub> (mm)	D <sub>2</sub> (mm)	H (mm)	L (mm)	(g)	(pcs.)	
New 10	15.5	24	4.5	23	41	10	*1
New 12	18	24	5.5	24	42	10	*1
New 13	19.2	24	6.5	25	43	10	*1
New 14	20.5	24	6.5	25	43	10	*1
New 15	21.7	29	7.5	26	70	10	*2
New 16	23	29	7.5	26	73	10	*2
New 17	24.2	29	7.5	26	76	10	*2
New 18	25.5	29	7.5	26	78	10	*2
New 19	26.7	29	9.5	28	79	10	*2
New 21	29.2	29	10	28.5	79	10	*2
New 22	30.5	29	10	28.5	84	10	*2
New 24	33	29	10	28.5	87	10	*2
New 27	36.7	29	10	28.5	100	10	*2

\*1 C-Ring=1401C, Pin/O-Ring=1401A/B

\*2 C-Ring=1402C, Pin/O-Ring=1402A/B

→ P254-255

RS14401MS/10	10 Pieces Set/Rail 300mm	(g)
New 10, 12, 13, 14, 17, 19, 21, 22, 24, 27		740

**14401MS** 6-point short sockets, Thin Walled  
6-kant Steckschlüssel kurz, dünnwandig  
Douilles 6-pans courtes, à paroi mince

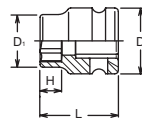

**RS14401MS/10**  
Socket Set on Rail  
Steckschlüsselsatz auf Schiene  
Jeu de douilles sur rail



14400MG (mm)	D <sub>1</sub> (mm)	D <sub>2</sub> (mm)	H (mm)	L (mm)	(g)	(pcs.)	
8	14.5	25	3.5	38	95	10	*1
10	17	25	4.2	38	95	10	*1
12	19.5	25	5.6	38	100	10	*1
13	20.7	25	6	38	100	10	*1
14	22	25	6.4	38	105	10	*1
15	23.2	30	6.8	38	140	10	*2
16	24.5	30	7	38	145	10	*2
17	25.7	30	7.5	38	145	10	*2
18	27	30	7.8	38	147	10	*2
19	28.2	30	8	38	147	10	*2
21	30.7	30	8	38	165	10	*2

\*1 C-Ring=1401C, Pin/O-Ring=1401A/B

\*2 C-Ring=1402C, Pin/O-Ring=1402A/B

→ P254-255

**14400MG** 6-point Sockets with Magnet  
6-kant Steckschlüssel mit Magnet  
Douilles 6-pans avec aimant

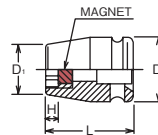

14401LH (LH-S)	D <sub>1</sub> (mm)	D <sub>2</sub> (mm)	H (mm)	L (mm)	(g)	(pcs.)	
6S	13	25	5.6	38	65	10	*1
8S	16.7	25	6.8	38	69	10	*1
10S	19.2	25	8	38	75	10	*1
12S	23	30	9.2	38	115	10	*2
14S	25.5	30	10.4	38	121	10	*2
16S	29.2	30	11.6	38	128	10	*2

\*1 C-Ring=1401C, Pin/O-Ring=1401A/B

\*2 C-Ring=1402C, Pin/O-Ring=1402A/B

→ P254-255

**14401LH** LHS Sockets  
Steckschlüssel mit LHS Profil  
Douilles au profil LHS

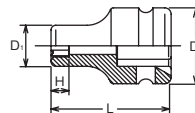

14410M (mm)	D <sub>1</sub> (mm)	D <sub>2</sub> (mm)	H (mm)	L (mm)	(g)	(pcs.)	
10	17	25	7	38	100	10	*1
11	18.2	25	8	38	103	10	*1
12	19.5	25	9	38	110	10	*1
13	20.7	25	10	38	113	10	*1
14	22	25	10	38	115	10	*1
15	23.2	30	11	38	120	10	*2
16	24.5	30	11	38	120	10	*2
17	25.7	30	12	38	126	10	*2
18	27	30	13	38	121	10	*2
19	28.2	30	13	38	124	10	*2
20	29.5	30	13	38	123	10	*2
21	30.7	30	14	38	120	10	*2
22	32	30	14	38	130	10	*2
24	34.5	30	14	38	134	10	*2
25	35.7	30	14	38	135	10	*2
26	37	30	14	38	160	10	*2
27	38.2	30	16	40	160	10	*2
28	39.5	30	16	40	170	10	*2
29	40.7	30	17	42	190	10	*2
30	42	30	17	42	190	10	*2
31	43.2	30	17	42	213	10	*2
32	44.5	30	18	42	216	10	*2
34	47	30	19	46	263	5	*2
36	49.5	30	20	46	285	5	*2

\*1 C-Ring=1401C, Pin/O-Ring=1401A/B

\*2 C-Ring=1402C, Pin/O-Ring=1402A/B

→ P254-255



**14410M** Surface Drive Sockets  
Surface Drive Steckschlüssel  
Douilles, Surface Drive

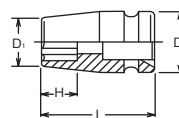

## SURFACE DRIVE

Surface drive sockets are designed to retain contact with the flat sides of the nut in order to transmit higher torque and reduce nut wear. These sockets are ideal for using on polished nuts, aluminum nuts and nuts with worn out points.

Das Profil unserer Surface-Drive Steckschlüssel greift die Schraube an deren Flächen. Dies sichert eine höhere Kraftübertragung und verhindert ein Durchrutschen des Steckschlüssels. Diese Steckschlüssel eignen sich besonders für polierte Schrauben, Aluminium Schrauben und Schrauben bei denen die Ecken bereits abgerundet sind.

Notre profil Surface Drive assure le contact entre la douille et les plats de l'écrou. Ceci réduit l'usure et permet la transmission d'un couple plus élevé. C'est une solution idéale pour les écrous polies, celles en aluminium ou arrondies.

Impact Sockets  
Impact Steckschlüssel  
Douilles Impact

1/2"

**14465M** Pathfinder Sockets  
Pathfinder Steckschlüssel  
Douilles Pathfinder

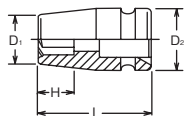

**PATHFINDER®**

The beveled flats of the 6-points opening of the PATHFINDER socket engage the nut almost immediately. PATHFINDER sockets are ideal for using with power tools in automatic assembly processes, as the power tool does not have to be totally stopped for the socket to engage the nut.

Da die Maschine nicht nach jedem Schraubvorgang angehalten werden muss, ergibt sich eine erhöhte Produktivität, die sich bei vollautomatischen Maschinen (Mehrspindelschrauber) ganz besonders auswirkt.

Les parois en biais des douilles en 6-pans Pathfinder assurent l'engagement quasi immédiat de l'écrou. Le fait de ne pas devoir arrêter la machine après chaque serrage, engendre une productivité supérieure dans les chaînes de montage automatiques.

14465M (mm)	D <sub>1</sub> (mm)	D <sub>2</sub> (mm)	H (mm)	L (mm)	(g)	(pcs.)	⚙️
10	17	25	8	38	89	10	*1
11	18.2	25	8	38	87	10	*1
12	19.5	25	9	38	87	10	*1
13	20.7	25	9	38	86	10	*1
14	22	25	11	38	86	10	*1
15	23.2	30	11	38	131	10	*2
16	24.5	30	11	38	131	10	*2
17	25.7	30	12	38	132	10	*2
18	27	30	13	38	128	10	*2
19	28.2	30	13	38	128	10	*2
20	29.5	30	14	38	125	10	*2
21	30.7	30	14	38	128	10	*2
22	32	30	15	38	130	10	*2
23	33.2	30	15	38	135	10	*2
24	34.5	30	15	38	135	10	*2
26	37	30	15	38	152	10	*2
27	38.2	30	16	40	169	10	*2

\*1 C-Ring=1401C, Pin/O-Ring=1401A/B  
\*2 C-Ring=1402C, Pin/O-Ring=1402A/B

**14415M** Double 4-point Socket  
Doppelvierkant Steckschlüssel  
Douilles 4-pans, doubles

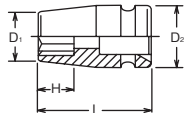

14415M (mm)	D <sub>1</sub> (mm)	D <sub>2</sub> (mm)	H (mm)	L (mm)	(g)	(pcs.)	⚙️
14	25.7	30	10	38	138	10	*1
15	27	30	11	38	145	10	*1
16	29.5	30	11	38	150	10	*1
17	30.7	30	12	38	155	10	*1
18	32	30	13	38	165	10	*1
19	33.2	30	14	38	170	10	*1
22	38.2	30	14	40	185	10	*1
24	42	30	14	42	215	10	*1
27	45.7	30	16	46	278	5	*1
28	47	30	16	46	285	5	*1
29	49.5	30	17	46	326	5	*2

\*1 C-Ring=1402C, Pin/O-Ring=1402A/B

**14425** TORX® Sockets  
TORX® Steckschlüssel  
Douilles TORX®

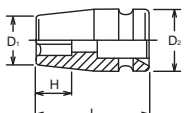

14425 (E)	D <sub>1</sub> (mm)	D <sub>2</sub> (mm)	H (mm)	L (mm)	(g)	(pcs.)	⚙️
E10	14.2	25	8.2	38	86	10	*1
E11	14.7	25	8.7	38	86	10	*1
E12	15.2	25	9.3	38	85	10	*1
E14	18.2	25	10.6	38	88	10	*1
E16	19.2	25	11.8	38	88	10	*1
E18	22.2	25	13	40	89	10	*1
E20	24.2	30	14.4	40	134	10	*2
E22	26.2	30	15.5	40	140	10	*2
E24	28.2	30	17	42	138	10	*2

\*1 C-Ring=1401C, Pin/O-Ring=1401A/B  
\*2 C-Ring=1402C, Pin/O-Ring=1402A/B

**14425-EPL** TORXPLUS® Sockets  
TORXPLUS® Steckschlüssel  
Douilles TORXPLUS®

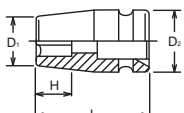

14425 (EPL)	D <sub>1</sub> (mm)	D <sub>2</sub> (mm)	H (mm)	L (mm)	(g)	(pcs.)	⚙️
10EPL	14.5	25	6.2	38	86	10	*1
12EPL	17	25	7.2	38	86	10	*1
14EPL	18.2	25	8.1	38	88	10	*1
16EPL	20.7	25	9.1	38	88	10	*1
18EPL	22	25	10.2	38	90	10	*1
20EPL	24.5	30	11.2	38	135	10	*2

\*1 C-Ring=1401C, Pin/O-Ring=1401A/B  
\*2 C-Ring=1402C, Pin/O-Ring=1402A/B

**14400-WN** Weld Nut Sockets  
Steckschlüssel für Schweißmutter  
Douille pour écrou à souder

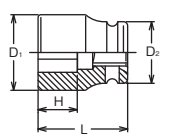

14400-WN	D <sub>1</sub> (mm)	D <sub>2</sub> (mm)	H (mm)	L (mm)	(g)	(pcs.)	⚙️
8WN	18.3	25	8	38	93	10	*1
9WN	19.5	25	9	38	93	10	*1
10WN	20.8	25	10	38	92	10	*1
12WN	24.5	30	12	38	139	10	*2
14WN	27	30	14	38	136	10	*2
17WN	32	30	17	40	150	10	*2

\*1 C-Ring=1401C, Pin/O-Ring=1401A/B  
\*2 C-Ring=1402C, Pin/O-Ring=1402A/B

Z-SERIES

HAND

TITANIUM

ACCESSORIES

SCREWDRIERS

IMPACT

SLEEVE-DRIVE

PROTECTOR

INDUSTRIAL

AUTOMOTIVE

MOTORCYCLE

CONSTRUCTION

SPARE PART

Z-SERIES  
HAND  
TITANIUM  
ACCESSORIES  
SCREWDRIVERS  
IMPACT  
SLEEVE-DRIVE  
PROTECTOR  
INDUSTRIAL  
AUTOMOTIVE  
MOTORCYCLE  
CONSTRUCTION  
SPARE PART

14301X (mm)	D <sub>1</sub> (mm)	D <sub>2</sub> (mm)	H <sub>1</sub> (mm)	H <sub>2</sub> (mm)	L (mm)	(g)	(pcs.)	
8	13	24	8	42	60	72	10	*1
9	14.2	24	9	42	60	75	10	*1
10	15.5	24	10	42	60	79	10	*1
11	16.7	24	11	42	60	82	10	*1
12	18	24	12	42	60	88	10	*1
13	19.2	24	13	42	60	92	10	*1
14	20.5	24	14	42	60	97	10	*1
15	21.7	29	15	42	60	125	10	*2
16	23	29	16	42	60	135	10	*2
17	24.2	29	17	42	60	142	10	*2
18	25.5	29	18	42	60	148	10	*2
19	26.7	29	19	41	60	151	10	*2
21	29.2	29	21	41	60	170	10	*2
22	30.5	29	22	45	65	187	10	*2
23	31.7	29	23	45	65	192	10	*2
24	33	29	24	45	65	202	10	*2
25	34.2	29	25	44	65	210	10	*2
26	35.5	29	26	44	65	218	10	*2
27	36.7	29	27	44	65	231	10	*2
30	40.5	29	30	44	65	268	10	*2
32	43	29	32	44	65	296	10	*2
33	44.2	29	33	44	65	318	2	*2
34	45.5	29	34	44	65	330	2	*2
36	48	29	36	44	65	350	2	*2

\*1 C-Ring=1401C, Pin/O-Ring=1401A/B  
\*2 C-Ring=1402C, Pin/O-Ring=1402A/B

➔ P254-255

RS14301X/10	10 Pieces Set/Rail 300mm	(g)
10, 12, 13, 14, 17, 19, 21, 22, 24, 27		1,585

**14301X** 6-point Semi-Deep Socket, Thin Walled  
6-kant Steckschlüssel mittel lang, dünnwandig  
Douilles à paroi mince semi-longues, 6-pans

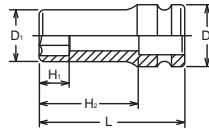

**RS14301X/10** Socket Set on Rail  
Steckschlüsselsatz auf Schiene  
Jeu de douilles sur rail



**14300M / 14300A** 6-point Deep Sockets  
6-kant-Steckschlüssel lang  
Douilles longues 6-pans

14300M (mm)	D <sub>1</sub> (mm)	D <sub>2</sub> (mm)	H <sub>1</sub> (mm)	H <sub>2</sub> (mm)	L (mm)	(g)	(pcs.)	
8	14.5	25	8	62	80	137	10	*1
9	15.7	25	9	62	80	138	10	*1
10	17	25	10	62	80	140	10	*1
11	18.2	25	11	62	80	156	10	*1
12	19.5	25	12	62	80	162	10	*1
13	20.7	25	13	62	80	162	10	*1
14	22	25	14	62	80	174	10	*1
15	23.2	30	15	62	80	220	10	*2
16	24.5	30	16	62	80	232	10	*2
17	25.7	30	17	62	80	232	10	*2
18	27	30	18	62	80	232	10	*2
19	28.2	30	19	61	80	259	10	*2
20	29.5	30	20	61	80	265	10	*2
21	30.7	30	21	61	80	265	10	*2
22	32	30	22	65	85	290	10	*2
23	33.2	30	23	65	85	300	10	*2
24	34.5	30	24	65	85	329	10	*2
25	35.7	30	25	65	85	345	10	*2
26	37	30	26	64	85	350	10	*2
27	38.2	30	27	64	85	385	10	*2
28	39.5	30	28	64	85	390	10	*2
29	40.7	30	29	63	85	416	10	*2
30	42	30	30	63	85	457	10	*2
31	43.2	30	31	63	85	505	10	*2
32	44.5	30	32	63	85	542	10	*2
33	45.7	30	33	62	85	562	2	*2
34	47	30	33	62	85	570	2	*2
35	48.2	30	35	62	85	600	2	*2
36	49.5	30	36	61	85	640	2	*2
38	52	30	38	60	85	655	2	*2
41	55.7	30	38	60	85	690	2	*2

\*1 C-Ring=1401C, Pin/O-Ring=1401A/B  
\*2 C-Ring=1402C, Pin/O-Ring=1402A/B

➔ P254-255

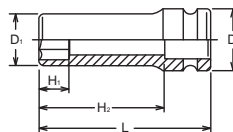

14300A (inch)	D <sub>1</sub> (mm)	D <sub>2</sub> (mm)	H <sub>1</sub> (mm)	H <sub>2</sub> (mm)	L (mm)	(g)	(pcs.)	
5/16	14.5	25	8	62	80	137	10	*1
3/8	17	25	10	62	80	140	10	*1
7/16	18.2	25	11	62	80	156	10	*1
1/2	20.7	25	13	62	80	162	10	*1
9/16	22	25	14	62	80	174	10	*1
5/8	24.5	30	16	62	80	232	10	*2
11/16	25.7	30	17	62	80	232	10	*2
3/4	28.2	30	19	61	80	259	10	*2
13/16	30.7	30	21	61	80	265	10	*2
7/8	32	30	22	65	85	290	10	*2
15/16	34.5	30	24	65	85	329	10	*2
1	35.7	30	25	65	85	345	10	*2
1. 1/16	38.2	30	27	64	85	385	10	*2
1. 1/8	40.7	30	29	63	85	416	10	*2
1. 3/16	42	30	30	63	85	457	10	*2
1. 1/4	44.5	30	32	63	85	542	10	*2
1. 7/16	50.7	30	37	61	85	580	2	*2
1. 1/2	52	30	38	61	85	600	2	*2

\*1 C-Ring=1401C, Pin/O-Ring=1401A/B  
\*2 C-Ring=1402C, Pin/O-Ring=1402A/B

➔ P254-255

Impact Sockets  
Impact Steckschlüssel 1/2"  
Douilles Impact

14301M / 14301A

6-point Deep Sockets, Thin Walled  
6-kant Steckschlüssel, dünnwandig  
Douilles à paroi mince longues, 6-pans

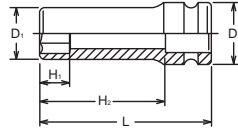

14301A (inch)	D <sub>1</sub> (mm)	D <sub>2</sub> (mm)	H <sub>1</sub> (mm)	H <sub>2</sub> (mm)	L (mm)	(g)	(pcs.)	
3/8	15.5	24	10	62	80	98	10	*1
7/16	16.7	24	11	62	80	104	10	*1
1/2	19.2	24	13	62	80	120	10	*1
9/16	20.5	24	14	62	80	127	10	*1
5/8	23	29	16	62	80	173	10	*2
11/16	24.2	29	17	62	80	182	10	*2
3/4	26.7	29	19	61	80	197	10	*2
13/16	29.2	29	21	61	80	218	10	*2
7/8	30.5	29	22	65	85	244	10	*2
15/16	33	29	24	65	85	261	10	*2
1. 1/16	36.7	29	27	64	85	314	10	*2
1. 1/8	39.2	29	29	63	85	349	10	*2

\*1 C-Ring=1401C, Pin/O-Ring=1401A/B  
\*2 C-Ring=1402C, Pin/O-Ring=1402A/B

→ P254-255

14305M

12-point Deep Sockets  
12-kant Steckschlüssel, lang  
Douilles longues 12-pans

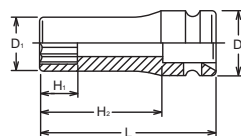

14301M (mm)	D <sub>1</sub> (mm)	D <sub>2</sub> (mm)	H <sub>1</sub> (mm)	H <sub>2</sub> (mm)	L (mm)	(g)	(pcs.)	
8	13	24	8	62	80	87	10	*1
9	14.2	24	9	62	80	92	10	*1
10	15.5	24	10	62	80	98	10	*1
11	16.7	24	11	62	80	104	10	*1
12	18	24	12	62	80	111	10	*1
13	19.2	24	13	62	80	120	10	*1
14	20.5	24	14	62	80	127	10	*1
15	21.7	29	15	62	80	169	10	*2
16	23	29	16	62	80	173	10	*2
17	24.2	29	17	62	80	182	10	*2
18	25.5	29	18	62	80	192	10	*2
19	26.7	29	19	61	80	197	10	*2
20	28	29	20	61	80	203	10	*2
21	29.2	29	21	61	80	218	10	*2
22	30.5	29	22	65	85	244	10	*2
23	31.7	29	23	65	85	253	10	*2
24	33	29	24	65	85	261	10	*2
25	34.2	29	25	65	85	282	10	*2
26	35.5	29	26	64	85	299	10	*2
27	36.7	29	27	64	85	314	10	*2
28	38	29	29	64	85	273	10	*2
29	39.2	29	29	63	85	280	10	*2
30	40.5	29	30	63	85	360	10	*2
31	41.7	29	31	63	85	370	10	*2
32	43	29	32	63	85	380	10	*2
34	45.5	29	34	62	85	411	2	*2
35	46.7	29	35	62	85	450	2	*2
36	48	29	36	61	85	460	2	*2
38	50.5	29	38	61	85	508	2	*2
41	54.2	29	38	60	85	552	2	*2

\*1 C-Ring=1401C, Pin/O-Ring=1401A/B  
\*2 C-Ring=1402C, Pin/O-Ring=1402A/B

→ P254-255

14305M (mm)	D <sub>1</sub> (mm)	D <sub>2</sub> (mm)	H <sub>1</sub> (mm)	H <sub>2</sub> (mm)	L (mm)	(g)	(pcs.)	
8	14.5	25	8	62	80	137	10	*1
10	17	25	10	62	80	140	10	*1
11	18.2	25	11	62	80	156	10	*1
12	19.5	25	12	62	80	162	10	*1
13	20.7	25	13	62	80	162	10	*1
14	22	25	14	62	80	174	10	*1
15	23.2	30	15	62	80	220	10	*2
16	24.5	30	16	62	80	232	10	*2
17	25.7	30	17	62	80	232	10	*2
18	27	30	18	62	80	232	10	*2
19	28.2	30	19	61	80	259	10	*2
20	29.5	30	20	61	80	265	10	*2
21	30.7	30	21	61	80	265	10	*2
22	32	30	22	65	85	290	10	*2
23	33.2	30	23	65	85	300	10	*2
24	34.5	30	24	65	85	329	10	*2
26	37	30	26	64	85	350	10	*2
27	38.2	30	27	64	85	385	10	*2
28	39.5	30	28	64	85	390	10	*2
29	40.7	30	29	63	85	416	10	*2
30	42	30	30	63	85	457	10	*2
32	44.5	30	32	63	85	542	10	*2
33	45.7	30	33	62	85	562	2	*2
36	49.5	30	36	61	85	635	2	*2

\*1 C-Ring=1401C, Pin/O-Ring=1401A/B  
\*2 C-Ring=1402C, Pin/O-Ring=1402A/B

→ P254-255

14306M

12-point Deep Sockets, Thin Walled  
12-kant Steckschlüssel, dünnwandig  
Douilles à paroi mince longues, 12-pans

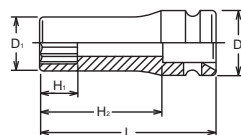

14306M (mm)	D <sub>1</sub> (mm)	D <sub>2</sub> (mm)	H <sub>1</sub> (mm)	H <sub>2</sub> (mm)	L (mm)	(g)	(pcs.)	
8	13	24	8	62	80	88	10	*1
10	15.5	24	10	62	80	98	10	*1
12	18	24	12	62	80	111	10	*1
13	19.2	24	13	62	80	120	10	*1
14	20.5	24	14	62	80	127	10	*1
15	21.7	29	15	62	80	169	10	*2
16	23	29	16	62	80	173	10	*2
17	24.2	29	17	62	80	182	10	*2
18	25.5	29	18	62	80	192	10	*2
19	26.7	29	19	61	80	197	10	*2
21	29.2	29	21	61	80	218	10	*2
22	30.5	29	22	65	85	244	10	*2
24	33	29	24	65	85	261	10	*2
27	36.7	29	27	64	85	314	10	*2
30	40.5	29	30	63	85	360	10	*2
32	43	29	32	63	85	380	10	*2

\*1 C-Ring=1401C, Pin/O-Ring=1401A/B  
\*2 C-Ring=1402C, Pin/O-Ring=1402A/B

→ P254-255

# 1/2"

## Impact Sockets Impact Steckschlüssel Douilles Impact

Z-SERIES  
HAND  
TITANIUM  
ACCESSORIES  
SCREWDRIVERS  
IMPACT  
SLEEVE-DRIVE  
PROTECTOR  
INDUSTRIAL  
AUTOMOTIVE  
MOTORCYCLE  
CONSTRUCTION  
SPARE PART

14310M (mm)	D <sub>1</sub> (mm)	D <sub>2</sub> (mm)	H <sub>1</sub> (mm)	H <sub>2</sub> (mm)	L (mm)	(g)	(pcs.)	
10	17	25	10	62	80	136	10	*1
11	18.2	25	11	62	80	148	10	*1
12	19.5	25	12	62	80	156	10	*1
13	20.7	25	13	62	80	158	10	*1
14	22	25	14	62	80	170	10	*1
15	23.2	30	15	62	80	225	10	*2
16	24.5	30	16	62	80	228	10	*2
17	25.7	30	17	62	80	232	10	*2
18	27	30	18	62	80	232	10	*2
19	28.2	30	19	61	80	252	10	*2
20	29.5	30	20	61	80	260	10	*2
21	30.7	30	21	61	80	260	10	*2
22	32	30	22	65	85	290	10	*2
23	33.2	30	23	65	85	300	10	*2
24	34.5	30	24	65	85	322	10	*2
25	35.7	30	25	65	85	338	10	*2
26	37	30	26	64	85	350	10	*2
27	38.2	30	27	64	85	380	10	*2
28	39.5	30	28	64	85	390	10	*2
29	40.7	30	29	63	85	416	10	*2
30	42	30	30	63	85	450	10	*2
31	43.2	30	31	63	85	505	10	*2
32	44.5	30	32	63	85	535	10	*2
34	47	30	34	62	85	563	2	*2
36	49.5	30	36	61	85	630	2	*2

\*1 C-Ring=1401C, Pin/O-Ring=1401A/B  
\*2 C-Ring=1402C, Pin/O-Ring=1402A/B

→ P254-255

14300G (mm)	D <sub>1</sub> (mm)	D <sub>2</sub> (mm)	H <sub>1</sub> (mm)	H <sub>2</sub> (mm)	L (mm)	(g)	(pcs.)	
10	17	25	4.5	26	80	139	10	*1
12	19.5	25	6	26	80	165	10	*1
13	20.7	25	6.5	25	80	185	10	*1
14	22	25	7	24	80	189	10	*1
15	23.2	30	7	24	80	240	10	*2
16	24.5	30	7.5	26.5	80	270	10	*2
17	25.7	30	8	26.5	80	272	10	*2
18	27	30	8.5	26.5	80	290	10	*2
19	28.2	30	9	27.5	80	308	10	*2

\*1 C-Ring=1401C, Pin/O-Ring=1401A/B  
\*2 C-Ring=1402C, Pin/O-Ring=1402A/B

→ P254-255

14365M (mm)	D <sub>1</sub> (mm)	D <sub>2</sub> (mm)	H <sub>1</sub> (mm)	H <sub>2</sub> (mm)	L (mm)	(g)	(pcs.)	
10	17	25	8	62	80	138	10	*1
11	18.2	25	8	62	80	144	10	*1
12	19.5	25	9	62	80	165	10	*1
13	20.7	25	9	62	80	170	10	*1
14	22	25	11	62	80	178	10	*1
15	23.2	30	11	62	80	237	10	*2
16	24.5	30	11	62	80	245	10	*2
17	25.7	30	12	62	80	263	10	*2
18	27	30	13	62	80	268	10	*2
19	28.2	30	13	61	80	270	10	*2
20	29.5	30	14	61	80	274	10	*2
21	30.7	30	14	61	80	287	10	*2
22	32	30	15	65	85	314	10	*2
23	33.2	30	15	65	85	320	10	*2
24	34.5	30	15	65	85	335	10	*2
26	37	30	15	64	85	388	10	*2
27	38.2	30	16	64	85	407	10	*2

\*1 C-Ring=1401C, Pin/O-Ring=1401A/B  
\*2 C-Ring=1402C, Pin/O-Ring=1402A/B

→ P254-255

14325 (E)	D <sub>1</sub> (mm)	D <sub>2</sub> (mm)	H <sub>1</sub> (mm)	H <sub>2</sub> (mm)	L (mm)	(g)	(pcs.)	
E10	14.2	25	8.2	62	80	136	10	*1
E12	15.2	25	9.3	62	80	141	10	*1
E14	18.2	25	10.6	62	80	147	10	*1
E16	19.2	25	11.8	62	80	151	10	*1
E18	22.2	25	13	62	80	218	10	*1
E20	24.2	30	14.4	62	80	225	10	*2

\*1 C-Ring=1401C, Pin/O-Ring=1401A/B  
\*2 C-Ring=1402C, Pin/O-Ring=1402A/B

→ P254-255



**14310M** ○ Surface Drive Sockets, deep  
Surface Drive Steckschlüssel, lang  
Douilles longues, Surface Drive

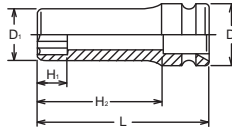

**14300G** ○ Impact Socket with Sliding Magnet  
Impact Steckschlüssel mit versenkbarem Magnet  
Douilles Impact avec aimant, glissant pour écrous

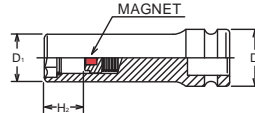
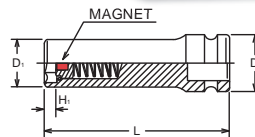

**14365M** ○ Pathfinder Sockets, deep  
Pathfinder Steckschlüssel, lang  
Douilles longues, Pathfinder

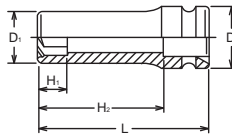

**14325** ○ TORX® Deep Sockets  
TORX® Steckschlüssel, lang  
Douilles longues TORX®

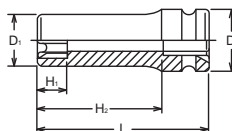

# Impact Sockets Impact Steckschlüssel Douilles Impact

# 1/2"

## 14440M / 14440A Universal Sockets Gelenk-Einsätze Douilles universelles

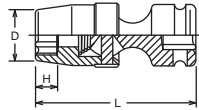

14440M (mm)	D (mm)	H (mm)	L (mm)	(g)	(pcs.)	
13	20.7	6	67.5	210	10	*2
14	22	7	69.5	210	10	*2
15	23.2	7	69.5	210	10	*2
16	24.5	8	69.5	206	10	*2
17	25.7	8	69.5	220	10	*2
18	27	9	69.5	218	10	*2
19	28.2	10	73.5	260	10	*2
20	29.5	10	73.5	270	10	*2
21	30.7	11	73.5	280	10	*2
22	32	13	73.5	290	10	*2
24	34.5	14	73.5	300	10	*2

14440A (inch)	D (mm)	H (mm)	L (mm)	(g)	(pcs.)	
1/2	20.7	6	67.5	210	10	*2
9/16	22	7	69.5	210	10	*2
5/8	24.5	8	69.5	206	10	*2
11/16	25.7	8	69.5	220	10	*2
3/4	28.2	10	73.5	260	10	*2

\*2 C-Ring=1402C, Pin/O-Ring=1402A/B → P254-255

## 14100M / 14100A Impact Screw and Stud Pullers Impact Stehbolzenzieher Extracteurs de goujons Impact

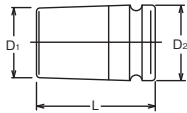

14100M (mm)	D1 (mm)	D2 (mm)	L (mm)	(g)	(pcs.)	
6	24	25	48	126	10	*1
7	24	25	48	126	10	*1
8	24	25	48	122	10	*1
9	28	30	48	181	10	*2
10	28	30	48	181	10	*2
12	28	30	48	175	10	*2

14100A (inch)	D1 (mm)	D2 (mm)	L (mm)	(g)	(pcs.)	
1/4	24	25	48	126	10	*1
5/16	24	25	48	122	10	*1
3/8	28	30	48	181	10	*2
7/16	28	30	48	181	10	*2
1/2	28	30	48	180	10	*2

\*1 C-Ring=1401C, Pin/O-Ring=1401A/B → P254-255  
\*2 C-Ring=1402C, Pin/O-Ring=1402A/B



Hexagon body design can lessen the excessive load on cages and rollers inside the pullers.

Der neue Körper mit sechs Walzenmulden verteilt den Druck auf den Käfig und die Walzen weitaus vorteilhafter.

La forme hexagonale du corps améliore les tolérances. Elle répartit l'effort de façon plus uniforme sur la cage et les rouleaux.

### Tolerance

	14100M (mm)		14100A (inch)
6	5.6- 6	1/4	6 - 6.4
7	6.6- 7	5/16	7.6- 8
8	7.6- 8	3/8	9 - 9.6
9	8.4- 9	7/16	10.5-11.1
10	9.4-10	1/2	12.1-12.7
12	11.4-12		

## 14103M Impact Stud Bolt Setters Impact Stehbolzensetzer Monte-goujons Impact

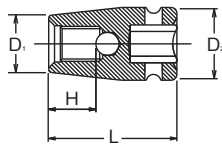

14103M (mm)	D1 (mm)	D2 (mm)	H (mm)	L (mm)	(g)	(pcs.)	
6(1.0)	12	25	10	42	75	10	*1
7(1.0)	13.2	25	11.4	42	78	10	*1
8(1.25)	14.5	25	11.5	42	81	10	*1
10(1.25)	17	25	13.5	49	106	10	*1
10(1.5)	17	25	13.5	49	106	10	*1
12(1.25)	19.5	25	15.5	49	107	10	*1
12(1.75)	19.5	25	15.5	49	107	10	*1
14(1.5)	22	25	18.2	55	128	10	*1
14(2.0)	22	25	18.2	55	128	10	*1

\*1 C-Ring=1401C, Pin/O-Ring=1401A/B → P254-255

 Depend on the stud bolt and using torque, 4103M/13103M/14103M may cause a scratch against the stud bolts or got stuck itself during a work.

A special socket for installing a stud bolt. Inside steel ball prevent the stud bolt stuck onto the socket. After installing a stud bolt, turn to anti-clockwise to removing the socket.

Spezialwerkzeug zum Setzen von Stehbolzen. Der Bolzen trifft im Werkzeug nur auf die gehärtete Stahlkugel, was die Kontaktfläche verringert. Nach dem Setzen des Stehbolzens kann das Werkzeug im Linkslauf vom Stehbolzen abgezogen werden.

Douilles spéciales pour monter les goujons. Le goujon est en contact avec une bille d'acier pour l'empêcher d'adhérer à la douille. Après avoir posé le goujon, tourner dans le sens antihorlogique pour le retirer

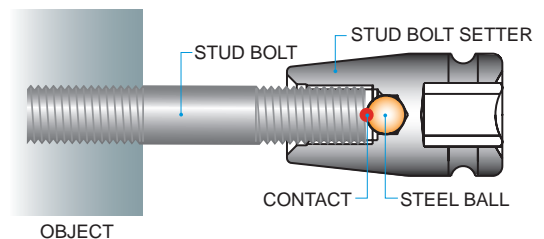



14145M-100 (mm)	D <sub>1</sub> (mm)	D <sub>2</sub> (mm)	H (mm)	L (mm)	(g)	(pce.)	
10	17	25	10	100	155	1	*1
12	19.5	25	12	100	165	1	*1
14	22	25	14	100	180	1	*1
17	25.7	25	17	100	210	1	*1
19	28.2	25	19	100	230	1	*1

14145M-150 (mm)	D <sub>1</sub> (mm)	D <sub>2</sub> (mm)	H (mm)	L (mm)	(g)	(pce.)	
10	17	25	10	150	190	1	*1
12	19.5	25	12	150	204	1	*1
13	20.7	25	13	150	216	1	*1
14	22	25	14	150	228	1	*1
15	23.2	25	15	150	240	1	*1
16	24.5	25	16	150	245	1	*1
17	25.7	25	17	150	253	1	*1
18	27	25	18	150	260	1	*1
19	28.2	25	19	150	267	1	*1

14145M-200 (mm)	D <sub>1</sub> (mm)	D <sub>2</sub> (mm)	H (mm)	L (mm)	(g)	(pce.)	
10	17	25	10	200	234	1	*1
12	19.5	25	12	200	248	1	*1
13	20.7	25	13	200	260	1	*1
14	22	25	14	200	272	1	*1
15	23.2	25	15	200	284	1	*1
16	24.5	25	16	200	290	1	*1
17	25.7	25	17	200	297	1	*1
18	27	25	18	200	305	1	*1
19	28.2	25	19	200	311	1	*1

14145M-250 (mm)	D <sub>1</sub> (mm)	D <sub>2</sub> (mm)	H (mm)	L (mm)	(g)	(pce.)	
10	17	25	10	250	278	1	*1
12	19.5	25	12	250	292	1	*1
13	20.7	25	13	250	304	1	*1
14	22	25	14	250	316	1	*1
15	23.2	25	15	250	328	1	*1
16	24.5	25	16	250	335	1	*1
17	25.7	25	17	250	341	1	*1
18	27	25	18	250	350	1	*1
19	28.2	25	19	250	355	1	*1

\*1 C-Ring=1401C, Pin/O-Ring=1401A/B → P254-255

## 14145M-100 / -150 / -200 / -250

○ Extra Long Sockets  
Schäftsteckschlüssel  
Douilles, série allongée

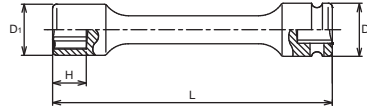

Z-SERIES  
HAND  
TITANIUM  
SCREWDRIVERS ACCESSORIES  
IMPACT  
SLEEVE-DRIVE  
PROTECTOR  
INDUSTRIAL  
AUTOMOTIVE  
CONSTRUCTION MOTORCYCLE  
SPARE PART

### 14146M-150 / -200 / -250

○ Extra Long Universal Sockets  
Schaftsteckschlüssel mit Gelenk  
Douilles, articulées, série allongée

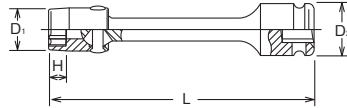

14146M-150 (mm)	D <sub>1</sub> (mm)	D <sub>2</sub> (mm)	H (mm)	L (mm)	(g)	(pce.)	Ⓢ
10	16	25	6.5	150	197	1	*1
12	19.3	25	7.5	150	200	1	*1
13	20	25	8	150	201	1	*1
14	21	25	8.5	150	203	1	*1
15	22	25	9	150	201	1	*1
16	23	25	9.5	150	200	1	*1
17	25	25	9.5	150	200	1	*1
18	26	25	11	150	210	1	*1
19	28	25	11.5	150	210	1	*1

14146M-200 (mm)	D <sub>1</sub> (mm)	D <sub>2</sub> (mm)	H (mm)	L (mm)	(g)	(pce.)	Ⓢ
10	16	25	6.5	200	241	1	*1
12	19.3	25	7.5	200	244	1	*1
13	20	25	8	200	245	1	*1
14	21	25	8.5	200	247	1	*1
15	22	25	9	200	245	1	*1
16	23	25	9.5	200	244	1	*1
17	25	25	9.5	200	244	1	*1
18	26	25	11	200	250	1	*1
19	28	25	11.5	200	254	1	*1

14146M-250 (mm)	D <sub>1</sub> (mm)	D <sub>2</sub> (mm)	H (mm)	L (mm)	(g)	(pce.)	Ⓢ
10	16	25	6.5	250	285	1	*1
12	19.3	25	7.5	250	288	1	*1
13	20	25	8	250	289	1	*1
14	21	25	8.5	250	291	1	*1
15	22	25	9	250	289	1	*1
16	23	25	9.5	250	288	1	*1
17	25	25	9.5	250	288	1	*1
18	26	25	11	250	290	1	*1
19	28	25	11.5	250	299	1	*1

\*1 C-Ring=1401C, Pin/O-Ring=1401A/B → P254-255

### 14147M-150 / -200

⊕ Extra Long Universal Inhex Sockets  
Schaftsteckschlüssel mit Aussensechskant Gelenk  
Douilles, articulées, à 6-pans mâle, série allongée

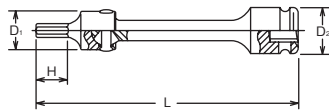

14147M-150 (mm)	D <sub>1</sub> (mm)	D <sub>2</sub> (mm)	H (mm)	L (mm)	(g)	(pce.)	Ⓢ
6	25	25	15	150	200	1	*1
8	25	25	15	150	205	1	*1
10	25	25	15	150	210	1	*1
12	25	25	15	150	217	1	*1

14147M-200 (mm)	D <sub>1</sub> (mm)	D <sub>2</sub> (mm)	H (mm)	L (mm)	(g)	(pce.)	Ⓢ
6	25	25	15	200	244	1	*1
8	25	25	15	200	249	1	*1
10	25	25	15	200	254	1	*1
12	25	25	15	200	261	1	*1

\*1 C-Ring=1401C, Pin/O-Ring=1401A/B → P254-255

# 1/2"

Impact Sockets  
Impact Steckschlüssel  
Douilles Impact

14012M-60 (mm)	D (mm)	H <sub>1</sub> (mm)	H <sub>2</sub> (mm)	L (mm)	(g)	(pcs.)	⚡
4	25	15.5	38	60	68	10	*1
5	25	15.5	38	60	71	10	*1
6	25	15.5	38	60	74	10	*1
7	25	15.5	38	60	80	10	*1
8	25	15.5	38	60	84	10	*1
10	30	15.5	38	60	140	10	*2
12	30	15.5	38	60	150	10	*2
14	30	15.5	38	60	170	10	*2
16	30	15.5	38	60	180	10	*2
17	30	15.5	38	60	190	10	*2
19	30	15.5	38	60	210	10	*2

\*1 C-Ring=1401C, Pin/O-Ring=1401A/B  
\*2 C-Ring=1402C, Pin/O-Ring=1402A/B

➔ P254-255

RS14012M/10-L60	10 Pieces Set/Rail 300mm	(g)
4, 5, 6, 7, 8, 10, 12, 14, 17, 19		1,300

## 14012M-60

⚡ Inhex Sockets  
Steckschlüssel für Innensechskant-Schrauben  
Douilles tournevis pour vis 6-pans creux

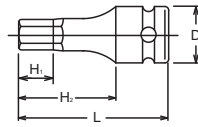

## RS14012M/10-L60

⚡ Socket Set on Rail  
Steckschlüsselsatz auf Schiene  
Jeu de douilles sur rail



14025-60 (T)	D (mm)	H (mm)	L (mm)	(g)	(pcs.)	⚡
T20	25	23.5	60	75	10	*1
T25	25	23.5	60	75	10	*1
T27	25	23.5	60	75	10	*1
T30	25	23.5	60	80	10	*1
T40	25	23.5	60	85	10	*1
T45	25	23.5	60	85	10	*1
T50	25	23.5	60	95	10	*1
T55	25	23.5	60	110	10	*1
T60	30	23.5	60	160	10	*2

14025-100 (T)	D (mm)	H (mm)	L (mm)	(g)	(pcs.)	⚡
T30	25	73.5	100	85	10	*1
T40	25	73.5	100	95	10	*1
T45	25	73.5	100	102	10	*1
T50	25	73.5	100	120	10	*1
T55	25	73.5	100	155	10	*1
T60	30	73.5	100	220	10	*2

\*1 C-Ring=1401C, Pin/O-Ring=1401A/B  
\*2 C-Ring=1402C, Pin/O-Ring=1402A/B

➔ P254-255

## 14025-60 / -100

⚡ TORX® Bit Sockets  
TORX® Bit-Steckschlüssel  
Douilles tournevis, TORX®

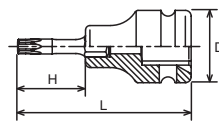

RS14025/6-L60	6 Pieces Set/Rail 200mm	(g)
T30, T40, T45, T50, T55, T60		650

## RS14025/6-L60

⚡ Socket Set on Rail  
Steckschlüsselsatz auf Schiene  
Jeu de douilles sur rail



# Impact Sockets Impact Steckschlüssel Douilles Impact

# 1/2"

Z-SERIES  
HAND  
TITANIUM  
SCREWDRIVERS ACCESSORIES  
IMPACT  
SLEEVE-DRIVE  
PROTECTOR  
INDUSTRIAL  
AUTOMOTIVE  
CONSTRUCTION MOTORCYCLE  
SPARE PART

## 14134 ○ Impact Bit Holder Impact Klingenhalter Porte embouts Impact

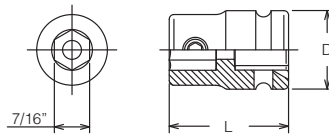

	D (mm)	L (mm)	(g)	(pcs.)	⚡
<b>14134</b>	25	38	90	10	*1

\*1 C-Ring=1401C, Pin/O-Ring=1401A/B → P254-255

For DIN3126 E11.2 Bits  
Für DIN3126 E11.2 Bits  
Pour DIN3126 E11.2 Embouts

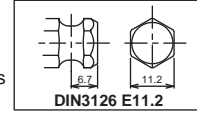

### 13134-SC

Replacement Screw : M8x5, ● 4mm  
Ersatzschraube : M8x5, ● 4mm  
Vis de remplacement : M8x5, ● 4mm

## 14142-F11.2 ○ Impact Bit Holder (Quick Release) Impact Klingenhalter (Quick Release) Porte embouts Impact (Quick Release) ⚠

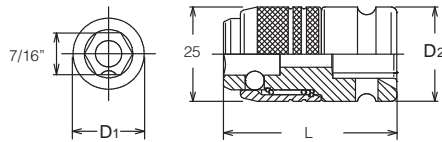

	D1 (mm)	D2 (mm)	L (mm)	(g)	(pcs.)	⚡
<b>14142-F11.2</b>	18.9	25	46	207	10	*1

\*1 C-Ring=1401C, Pin/O-Ring=1401A/B → P254-255

For DIN3126 E11.2 Bits  
Für DIN3126 E11.2 Bits  
Pour DIN3126 E11.2 Embouts

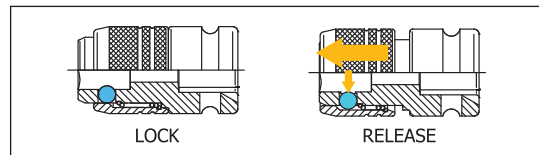
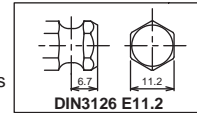

⚠ You may not hold the sliding part while moving to avoid heating up by friction and reduction by wear.

## 183H-35 / -75 / -150 ● Hex Bits Sechskant Bits Embouts, 6 pans creus

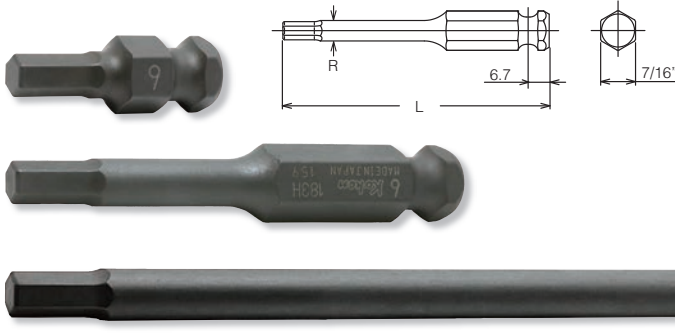

183H-35 (inch)	L (mm)	(g)	(pcs.)
<b>3/16</b>	35	15	10
<b>7/32</b>	35	16	10
<b>1/4</b>	35	18	10
<b>5/16</b>	35	20	10
<b>3/8</b>	35	26	10
<b>7/16</b>	35	28	10
<b>1/2</b>	35	38	10

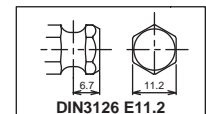

183H-35 (mm)	L (mm)	(g)	(pcs.)
<b>3</b>	35	15	10
<b>4</b>	35	15	10
<b>5</b>	35	15	10
<b>6</b>	35	18	10
<b>7</b>	35	19	10
<b>8</b>	35	20	10
<b>9</b>	35	23	10
<b>10</b>	35	26	10
<b>11</b>	35	28	10
<b>12</b>	35	30	10
<b>14</b>	35	35	10
<b>16</b>	35	47	10
<b>17</b>	35	50	10
<b>18</b>	35	53	10
<b>19</b>	35	56	10

183H-75 (mm)	L (mm)	R (mm)	(g)	(pcs.)
<b>3</b>	75	6	34	10
<b>4</b>	75	6	35	10
<b>5</b>	75	6.5	36	10
<b>6</b>	75	7.5	39	10
<b>7</b>	75	8.5	44	10
<b>8</b>	75	9.5	47	10
<b>10</b>	75	-	57	10
<b>11</b>	75	-	60	10
<b>12</b>	75	-	65	10
<b>14</b>	75	-	79	10

183H-150 (mm)	L (mm)	R (mm)	(g)	(pcs.)
<b>4</b>	150	6	51	10
<b>5</b>	150	6.5	55	10
<b>6</b>	150	7.5	65	10
<b>8</b>	150	9.5	87	10
<b>10</b>	150	-	118	10
<b>12</b>	150	-	136	10

# 1/2"

Impact Sockets  
Impact Steckschlüssel  
Douilles Impact

Z-SERIES  
HAND  
TITANIUM  
ACCESSORIES  
SCREWDRIVERS  
IMPACT  
SLEEVE-DRIVE  
PROTECTOR  
INDUSTRIAL  
AUTOMOTIVE  
MOTORCYCLE  
CONSTRUCTION  
SPARE PART

## 183T-35 / -75 / -150 (T)

TORX® Bits  
TORX® Bits  
Embout, TORX®

183T-35 (T)	L (mm)	(g)	(pcs.)
T25	35	18	10
T30	35	18	10
T40	35	20	10
T45	35	22	10
T50	35	26	10
T55	35	30	10
T60	35	38	10

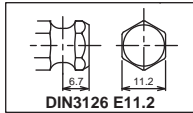
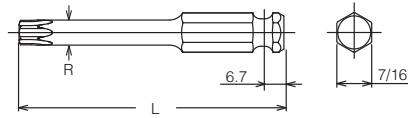

183T-75 (T)	L (mm)	R (mm)	(g)	(pcs.)
T30	75	6	35	10
T40	75	6.9	37	10
T45	75	8	41	10
T50	75	9	45	10
T55	75	11.4	55	10
T60	75	13.5	67	10

183T-150 (T)	L (mm)	R (mm)	(g)	(pcs.)
T30	150	6	50	10
T40	150	6.9	58	10
T45	150	8	70	10
T50	150	9	82	10
T55	150	11.4	113	10

## 183T-35 / -75 (IP)

TORXPLUS® Bits  
TORXPLUS® Bits  
Embout TORXPLUS®

**TORXplus**

183T-35 (IP)	L (mm)	(g)	(pcs.)
30IP	35	18	10
40IP	35	20	10
45IP	35	22	10
50IP	35	26	10
55IP	35	30	10
60IP	35	38	10

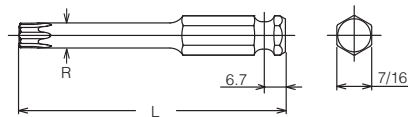

183T-75 (IP)	L (mm)	R (mm)	(g)	(pcs.)
30IP	75	6	35	10
40IP	75	6.8	37	10
45IP	75	8	41	10
50IP	75	9	45	10
55IP	75	11.4	56	10
60IP	75	13.5	67	10

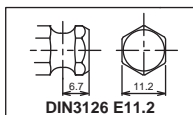

## 183X-35 / -75 / -150 (XZN)

XZN Bits  
XZN Bits  
Embout, XZN

183X-35 (XZN)	L (mm)	(g)	(pcs.)
M 4	35	18	10
M 5	35	18	10
M 6	35	20	10
M 8	35	22	10
M10	35	26	10
M12	35	30	10
M14	35	38	10

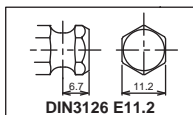
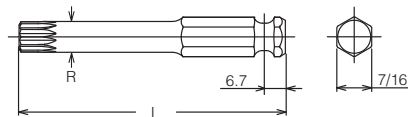

183X-75 (XZN)	L (mm)	R (mm)	(g)	(pcs.)
M 4	75	6	34	10
M 5	75	6	34	10
M 6	75	6.2	36	10
M 8	75	7.4	39	10
M10	75	9.8	54	10
M12	75	11.7	57	10
M14	75	13.5	67	10

183X-150 (XZN)	L (mm)	R (mm)	(g)	(pcs.)
M 5	150	6	50	10
M 6	150	6.2	53	10
M 8	150	7.4	64	10
M10	150	9.8	93	10
M12	150	11.7	121	10

# Impact Sockets Impact Steckschlüssel Douilles Impact

# 1/2"

Z-SERIES  
HAND  
TITANIUM  
SCREWDRIVERS  
ACCESSORIES  
IMPACT  
SLEEVE-DRIVE  
PROTECTOR  
INDUSTRIAL  
AUTOMOTIVE  
MOTORCYCLE  
CONSTRUCTION  
SPARE PART

## 14134M-58 / -98

Bit Holder complete with Bit, Inhex  
Klingenhalter komplett mit Klinge, Innensechskant  
Porte embouts avec bit 6-pans creux



14134M-58/-98 (mm)	D (mm)	H (mm)	L (mm)	L (mm)	R (mm)	L=58 (g)	L=98 (g)	L=58 (pcs.)	L=98 (pcs.)	Ⓢ
3	25	20.6	58	98	6	105	124	10	5	*1
4	25	20.6	58	98	6	105	125	10	5	*1
5	25	20.6	58	98	6.5	105	126	10	5	*1
6	25	20.6	58	98	7.5	108	129	10	5	*1
8	25	20.6	58	98	9.5	110	137	10	5	*1
10	25	20.6	58	98	-	116	147	10	5	*1
12	25	20.6	58	98	-	120	155	10	5	*1
14	25	20.6	58	98	-	125	169	10	5	*1

\*1 C-Ring=1401C, Pin/O-Ring=1401A/B → P254-255

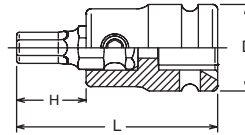

## 14134T-58 / -98 (T)

Bit Holder complete with TORX® Bit  
Klingenhalter, komplett mit TORX® Klinge  
Porte embouts avec bit TORX®



14134T-58/-98 (T)	D (mm)	H (mm)	L (mm)	L (mm)	R (mm)	L=58 (g)	L=98 (g)	L=58 (pcs.)	L=98 (pcs.)	Ⓢ
T30	25	20.6	58	98	6	108	125	10	5	*1
T40	25	20.6	58	98	6.9	110	127	10	5	*1
T45	25	20.6	58	98	8	112	131	10	5	*1
T50	25	20.6	58	98	9	116	135	10	5	*1
T55	25	20.6	58	98	11.4	120	145	10	5	*1
T60	25	20.6	58	98	13.5	128	157	10	5	*1

\*1 C-Ring=1401C, Pin/O-Ring=1401A/B → P254-255

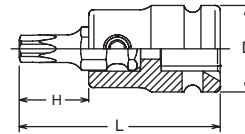

## 14134T-58 / -98 (IP)

Bit Holder complete with TORXPLUS® Bit  
Klingenhalter, komplett mit TORXPLUS® Klinge  
Porte embouts avec bit TORXPLUS®



14134T-58/-98 (IP)	D (mm)	H (mm)	L (mm)	L (mm)	R (mm)	L=58 (g)	L=98 (g)	L=58 (pcs.)	L=98 (pcs.)	Ⓢ
30IP	25	20.6	58	98	6	108	125	10	5	*1
40IP	25	20.6	58	98	6.8	110	127	10	5	*1
45IP	25	20.6	58	98	8	112	131	10	5	*1
50IP	25	20.6	58	98	9	116	135	10	5	*1
55IP	25	20.6	58	98	11.4	120	146	10	5	*1
60IP	25	20.6	58	98	13.5	128	159	10	5	*1

\*1 C-Ring=1401C, Pin/O-Ring=1401A/B → P254-255

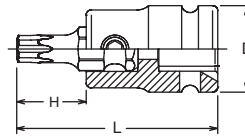

## 14134X-58 / -98 (XZN)

Bit Holder complete with XZN Bit  
Klingenhalter, komplett mit XZN Klinge  
Porte embouts avec bit XZN



14134X-58/-98 (XZN)	D (mm)	H (mm)	L (mm)	L (mm)	R (mm)	L=58 (g)	L=98 (g)	L=58 (pcs.)	L=98 (pcs.)	Ⓢ
M 5	25	20.6	58	98	6	108	124	10	5	*1
M 6	25	20.6	58	98	6.2	110	126	10	5	*1
M 8	25	20.6	58	98	7.4	112	129	10	5	*1
M10	25	20.6	58	98	9.8	116	144	10	5	*1
M12	25	20.6	58	98	11.7	120	149	10	5	*1
M14	25	20.6	58	98	13.5	128	159	10	5	*1

\*1 C-Ring=1401C, Pin/O-Ring=1401A/B → P254-255

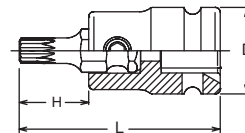

	D <sub>1</sub> (mm)	D <sub>2</sub> (mm)	L (mm)	(g)	(pcs.)	
<b>14106</b>	28	30	43	160	10	*2

\*2 C-Ring=1402C, Pin/O-Ring=1402A/B → P254-255

14106-SC

 Replacement Screw : M6x8, 3mm

## 14106 Bit Holder Klingenhalter Porte-embout

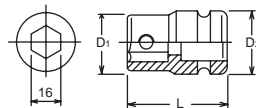

107-16 (mm)	L (mm)	(g)	(pcs.)
10	40	46	10
12	40	52	10
13	40	56	10
14	40	60	10
16	40	69	10
17	40	73	10
18	40	78	10
19	40	80	10
22	40	97	10

107-16 (inch)	L (mm)	(g)	(pcs.)
3/8	40	45	10
1/2	40	56	10
9/16	40	60	10
5/8	40	69	10
3/4	40	80	10

107-16(L100) (mm)	L (mm)	R (mm)	(g)	(pcs.)
10	100	13	122	10
12	100	15	146	10
14	100	-	166	10
17	100	-	193	10
19	100	-	232	10
22	100	-	254	10

107-16 (T)	L (mm)	(g)	(pcs.)
T55	50	57	10
T60	50	64	10
T70	50	73	10

107-16(L100) (T)	L (mm)	R (mm)	(g)	(pcs.)
T55	100	11.4	108	10
T60	100	13.4	130	10
T70	100	15.7	159	10

107-16 (IP)	L (mm)	(g)	(pcs.)
55IP	50	57	10
60IP	50	64	10
70IP	50	73	10

107-16 (XZN)	L (mm)	(g)	(pcs.)
M14	60	83	10
M16	60	93	10
M18	60	103	10

107-16(L100) (XZN)	L (mm)	R (mm)	(g)	(pcs.)
M14	100	13.4	131	10
M16	100	15.8	161	10
M18	100	17.1	177	10

## 107-16 Bits for Inhex Screws Klingen für Innensechskant-Schrauben Embouts pour vis 6-pans males creux

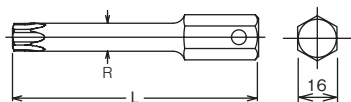
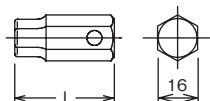

## 107-16 (T) TORX® Bits TORX® Klingen Embouts, TORX®

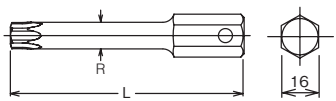
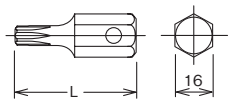

## 107-16 (IP) TORXPLUS® Bits TORXPLUS® Klingen Embouts TORXPLUS®

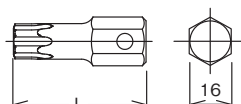

## 107-16 (XZN) Bits XZN Klingen XZN Embouts de vissage, XZN

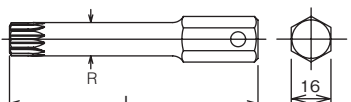
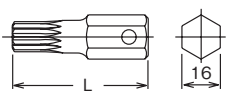

# Impact Sockets Impact Steckschlüssel Douilles Impact

# 1/2"

Z-SERIES  
HAND  
TITANIUM  
SCREWDRIVERS ACCESSORIES  
IMPACT  
SLEEVE-DRIVE  
PROTECTOR  
INDUSTRIAL  
AUTOMOTIVE  
MOTORCYCLE  
CONSTRUCTION  
SPARE PART

## 14139 ○ Bit Holder Klingenhalter Porte-embouts

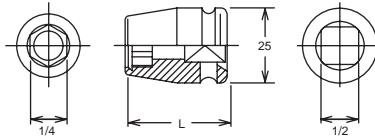

	D <sub>1</sub> (mm)	D <sub>2</sub> (mm)	L (mm)	(g)	(pcs.)	⚡
14139-1/4	11	25	35	62	10	*1

\*1 C-Ring=1401C, Pin/O-Ring=1401A/B → P254-255

For DIN3126 C6.3 Bits  
Für DIN3126 C6.3 Bits  
Pour DIN3126 C6.3 Embouts

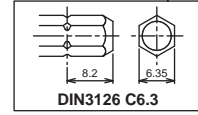

## 14140 ○ Bit Holder Klingenhalter Porte-embouts

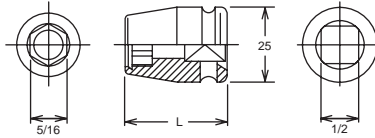

	D <sub>1</sub> (mm)	D <sub>2</sub> (mm)	L (mm)	(g)	(pcs.)	⚡
14140-5/16	14	25	35	62	10	*1

\*1 C-Ring=1401C, Pin/O-Ring=1401A/B → P254-255

For DIN3126 C8 Bits  
Für DIN3126 C8 Bits  
Pour DIN3126 C8 Embouts

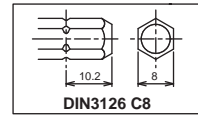

## 14142-D6.3 ○ Bit Holder (Quick Release) Kingenhalter (Schnellwechselfutter) Porte embouts (mandrin autoserrant) ⚠

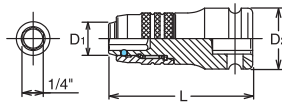

	D <sub>1</sub> (mm)	D <sub>2</sub> (mm)	L (mm)	(g)	(pcs.)	⚡
14142-D6.3	16	25	55	97	10	*1

\*1 C-Ring=1401C, Pin/O-Ring=1401A/B → P254-255

For DIN3126 C6.3 Bits  
Für DIN3126 C6.3 Bits  
Pour DIN3126 C6.3 Embouts

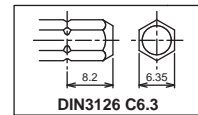

⚠ You may not hold the sliding part while moving to avoid heating up by friction and reduction by wear.

## 14142-F6.3 ○ Bit Holder (Quick Release) Kingenhalter (Schnellwechselfutter) Porte embouts (mandrin autoserrant) ⚠

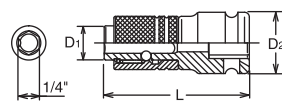

	D <sub>1</sub> (mm)	D <sub>2</sub> (mm)	L (mm)	(g)	(pcs.)	⚡
14142-F6.3	16.5	25	55	100	10	*1

\*1 C-Ring=1401C, Pin/O-Ring=1401A/B → P254-255

For DIN3126 E6.3 Bits  
Für DIN3126 E6.3 Bits  
Pour DIN3126 E6.3 Embouts

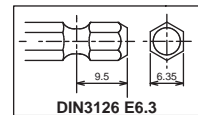

### Lock & Quick Release

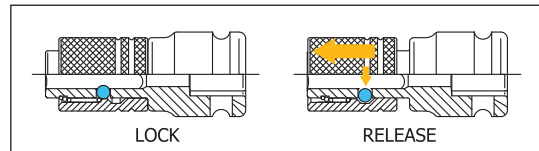

⚠ You may not hold the sliding part while moving to avoid heating up by friction and reduction by wear.



## 14760-P 14760

Extension Bars  
Verlängerungen  
Rallonges



	TYPE	D (mm)	L (mm)	(g)	(pcs.)	
14760-50P	Pin	30	50	150	10	*2
14760-50	Hole	30	50	150	10	*2
14760-75P	Pin	30	75	188	10	*2
14760-75	Hole	30	75	188	10	*2
14760-100P	Pin	30	100	240	10	*2
14760-100	Hole	30	100	240	10	*2
14760-125P	Pin	30	125	275	5	*2
14760-125	Hole	30	125	275	5	*2
14760-150P	Pin	30	150	300	5	*2
14760-150	Hole	30	150	300	5	*2
14760-175P	Pin	30	175	358	5	*2
14760-175	Hole	30	175	358	5	*2
14760-200P	Pin	30	200	405	5	*2
14760-200	Hole	30	200	405	5	*2
14760-250P	Pin	30	250	480	1	*2
14760-250	Hole	30	250	480	1	*2

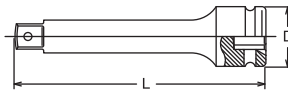

\*2 C-Ring=1402C, Pin/O-Ring=1402A/B → P254-255

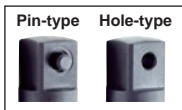

	L (mm)	(g)	(pcs.)	
14444AL	60	128	10	*1

\*1 C-Ring=1401C, Pin/O-Ring=1401A/B → P254-255

### Lock & Quick Release

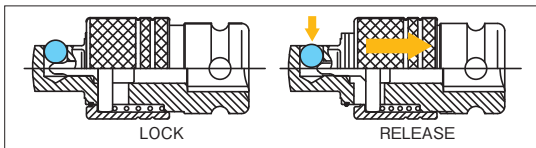

**⚠** You may not hold the sliding part while moving to avoid heating up by friction and reduction by wear.



LOCKING ADAPTOR

## 14444AL

Adaptor (Quick Release)  
Verbindungsstück (Quick Release) ⚠  
Adaptateur (Quick Release)

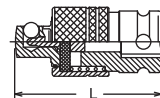

# Impact Sockets Impact Steckschlüssel Douilles Impact

# 1/2"

Z-SERIES  
HAND  
TITANIUM  
SCREWDRIVERS  
ACCESSORIES  
IMPACT  
SLEEVE-DRIVE  
PROTECTOR  
INDUSTRIAL  
AUTOMOTIVE  
MOTORCYCLE  
CONSTRUCTION  
SPARE PART

## 14770-P 14770

Universal Joint  
Gelenk-Einsatz  
Joint articulé

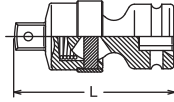
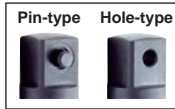

	TYPE	L (mm)	(g)	(pcs.)	
14770-P	Pin	74	210	5	*2
14770	Hole	74	210	5	*2
14771-P	Pin	65	198	5	*2
14771	Hole	65	198	5	*2

\*2 C-Ring=1402C, Pin/O-Ring=1402A/B → P254-255

Our ball joints are spring-loaded and can therefore be adjusted to an angle of max. 30°.

Unsere Kugelgelenke sind federbelastet dadurch sind sie auf einen Winkel von max 30° einstellbar.

Nos joints à rotule sont à ressort et peuvent donc être réglés jusqu'à un angle de 30° maximum.

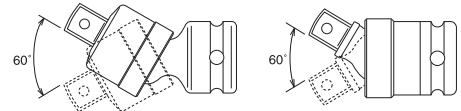

## 14771-P 14771

Universal Joint  
Gelenk-Einsatz  
Joint articulé

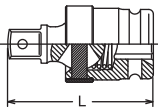

## 14772-P

Universal Double Joint  
Doppelgelenk-Einsatz  
Joint articulé double

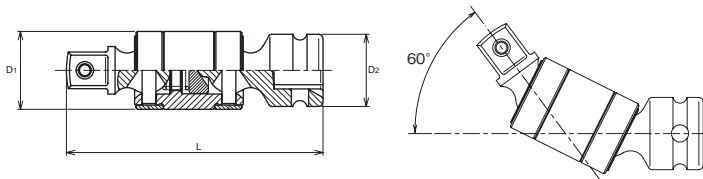

	D <sub>1</sub> (mm)	D <sub>2</sub> (mm)	L (mm)	(g)	(pcs.)	
14772-P	27	25	90	230	5	*1

\*1 C-Ring=1401C, Pin/O-Ring=1401A/B → P254-255

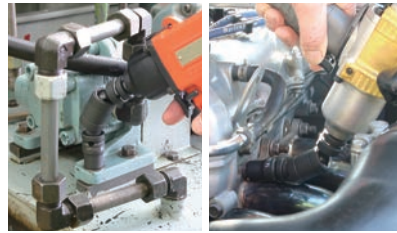

Make sure sockets hold bolts or nuts before operation.

Vergewissern Sie sich vor dem Gebrauch, dass der Steckschlüssel die Schraube sicher umfasst hat.

Avant la manipulation, il est nécessaire de s'assurer que la douille renferme parfaitement la vis.

⚠ 13772 and 14772 have less load capacity than standard. In the interest of your safety always use properly.

## 14433A-P 14433A

Adaptor  
Verbindungsstück  
Réducteur

No Warranty  
Keine Garantie  
Sans Garantie

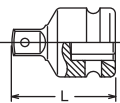

## 14455A

Adaptor  
Verbindungsstück  
Augmentateur

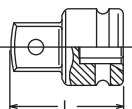

## 14466A

Adaptor  
Verbindungsstück  
Augmentateur

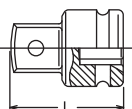

	TYPE	(sq.)	(sq.)	L (mm)	(g)	(pcs.)	
14433A-P	Pin	1/2"	3/8"	37.5	68	10	*1
14433A	Hole	1/2"	3/8"	37.5	68	10	*1

\*1 C-Ring=1401C, Pin/O-Ring=1401A/B → P254-255

⚠ Adapting down from bigger square drive to smaller square drive may lead to excessive torque load and possibly cause breakage. Always stay within safe torque of the smaller square drive.

Die mit ⚠ gekennzeichneten Artikel können bei Überbelastung zu Bruch gehen. Aus Gründen Ihrer eigenen Sicherheit sollten die betreffenden Werkzeuge nie ruckartig, sondern nach und nach belastet werden, um Bruch und damit verbundene mögliche Verletzungen zu vermeiden.

Il est possible d'appliquer aux articles marqués ⚠ des couples de serrage susceptibles d'occasionner leur rupture. Pour votre propre sécurité, veuillez toujours appliquer la charge d'une manière uniforme et progressive. Ceci pour éviter ruptures et accidents.

	(sq.)	(sq.)	L (mm)	(g)	(pcs.)	
14455A	1/2"	5/8"	42	135	10	*2





\*2 C-Ring=1402C, Pin/O-Ring=1402A/B → P254-255

	(sq.)	(sq.)	L (mm)	(g)	(pcs.)	
14466A	1/2"	3/4"	44	146	10	*2

\*2 C-Ring=1402C, Pin/O-Ring=1402A/B → P254-255

**14209M** 10 Pieces Set/△=830g

METAL CASE:W190xH59xT45mm

Bits	Bit Holder
 <b>183H.35</b> Hex Bits 5, 6, 8, 10	 <b>14134</b> Bit Holder
 <b>107.16</b> Hex Bits 12, 14, 17, 19	 <b>14106</b> Bit Holder

 × 





 ×  DIN3126

**14209M**  Socket Sets  
Steckschlüssel Sätze  
Jeu de clés à douilles



**14210M** 18 Pieces Set/△=1,250g

METAL CASE:W310xH90xT48mm

Bits	Bit Holder
 <b>183H.35</b> Hex Bits 4, 5, 6, 7, 8, 10, 12, 14	 <b>14134</b> Bit Holder
 <b>183H.75</b> Hex Bits 4, 5, 6, 7, 8, 10, 12, 14	 <b>168H-4 (40)</b> Screwdriver

 × 





 ×  DIN3126

**14210M**  Socket Sets  
Steckschlüssel Sätze  
Jeu de clés à douilles



**14210T** 14 Pieces Set/△=1,080g

METAL CASE:W310xH90xT48mm

Bits	Bit Holder
 <b>183T.35</b> TORX® Bits T30, T40, T45, T50, T55, T60	 <b>14134</b> Bit Holder
 <b>183T.75</b> TORX® Bits T30, T40, T45, T50, T55, T60	 <b>168H-4 (40)</b> Screwdriver

 × 





 ×  DIN3126

**14210T**  Socket Sets  
Steckschlüssel Sätze  
Jeu de clés à douilles



**14210X** 14 Pieces Set/△=1,040g

METAL CASE:W310xH90xT48mm

Bits	Bit Holder
 <b>183X.35</b> XZN Bits M4, M5, M6, M8, M10, M12	 <b>14134</b> Bit Holder
 <b>183X.75</b> XZN Bits M4, M5, M6, M8, M10, M12	 <b>168H-4 (40)</b> Screwdriver

 × 

 ×  DIN3126

**14210X**  Socket Sets  
Steckschlüssel Sätze  
Jeu de clés à douilles

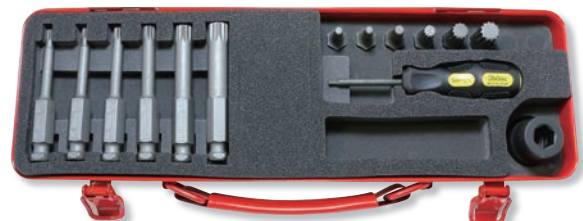

Impact Sockets  
Impact Steckschlüssel  
Douilles Impact

# 1/2"

Z-SERIES

HAND

TITANIUM

ACCESSORIES

SCREWDRIVERS

IMPACT

SLEEVE-DRIVE

PROTECTOR

INDUSTRIAL

AUTOMOTIVE

MOTORCYCLE

CONSTRUCTION

SPARE PART

**14207M**  Socket Set  
Steckschlüssel Satz  
Jeu de clés à douilles



**14207M** 10 Pieces Set/△=2,700g

METAL CASE:W310xH90xT48mm

Sockets

 **14300M** 6-pt Deep Sockets  
10, 12, 13, 14, 17, 19, 21, 22, 24, 27

**14208M**  Socket Set  
Steckschlüssel Satz  
Jeu de clés à douilles



**14208M** 13 Pieces Set/△=3,500g

METAL CASE:W395xH90xT50mm

Sockets

 **14300M** 6-pt Deep Sockets  
10, 12, 13, 14, 15, 16, 17, 18, 19, 21, 22, 24, 27

**14241M-00**  Socket Set  
Steckschlüssel Satz  
Jeu de clés à douilles



**14241M-00** 13 Pieces Set/△=2,000g

METAL CASE:W196xH100xT45mm

Sockets

 **14400M** 6-pt. Sockets  
10, 11, 12, 13, 14, 15, 16, 17, 19, 21, 22, 24, 27

**14241M-05** 

**14241M-05** 13 Pieces Set/△=2,000g

METAL CASE:W196xH100xT45mm

Sockets

 **14405M** 12-pt. Sockets  
10, 11, 12, 13, 14, 15, 16, 17, 19, 21, 22, 24, 27

**14242M**  Socket Set  
Steckschlüssel Satz  
Jeu de clés à douilles



**14242M** 12 Pieces Set/△=1,890g

METAL CASE:W310xH90xT48mm

Sockets

 **14400M** 6-pt. Sockets  
10, 11, 12, 13, 14, 15, 16, 17, 19, 21, 22, 27

**14245M-00**  Socket Set  
Steckschlüssel Satz  
Jeu de clés à douilles







**14245M-00** 18 Pieces Set/△=2,250g

METAL CASE:W310xH90xT48mm

Sockets

 **14400M** 6-pt. Sockets  
10, 12, 13, 14, 16, 17, 18,  
19, 21, 22, 24, 27

Accessories

 **14760-125P**  
 **14770-P**  
 **1401A, 1402A**  
 **1401B, 1402B**





**14245M-05** 18 Pieces Set/△=2,250g

METAL CASE:W310xH90xT48mm

Sockets

 **14405M** 12-pt. Sockets  
10, 12, 13, 14, 16, 17, 18,  
19, 21, 22, 24, 27

Accessories

 **14760-125P**  
 **14770-P**  
 **1401A, 1402A**  
 **1401B, 1402B**

15400M (mm)	D <sub>1</sub> (mm)	D <sub>2</sub> (mm)	H (mm)	L (mm)	(g)	(pcs.)	
14	24	35	10	47.5	220	5	*1
17	27.8	35	12	47.5	225	5	*1
19	30.3	35	13	47.5	225	5	*1
21	32.8	35	15	47.5	225	5	*1
22	34	35	15	47.5	225	5	*1
23	35.4	35	16	47.5	225	5	*1
24	36.5	35	16	50.5	245	5	*1
26	39	35	16	50.5	260	1	*1

\*1 Pin/O-Ring=1500A/B → P255



**15400M** 6-point Sockets  
6-kant Steckschlüssel  
Douilles 6-pans

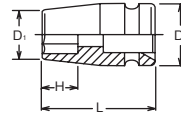

15410M (mm)	D <sub>1</sub> (mm)	D <sub>2</sub> (mm)	H (mm)	L (mm)	(g)	(pcs.)	
14	24	35	10	47.5	220	5	*1
17	27.8	35	12	47.5	225	5	*1
19	30.3	35	13	47.5	225	5	*1
21	32.8	35	15	47.5	225	5	*1
22	34	35	15	47.5	225	5	*1
23	35.4	35	16	47.5	225	5	*1
24	36.5	35	16	50.5	245	5	*1
26	39	35	16	50.5	260	5	*1

\*1 Pin/O-Ring=1500A/B → P255



**15410M** Surface Drive Sockets  
Surface Drive Steckschlüssel  
Douilles, Surface Drive

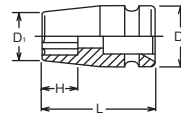

15300M (mm)	D <sub>1</sub> (mm)	D <sub>2</sub> (mm)	H <sub>1</sub> (mm)	H <sub>2</sub> (mm)	L (mm)	(g)	(pcs.)	
14	24	35	14	71	90	295	2	*1
17	27.8	35	17	71	90	325	2	*1
19	30.3	35	19	71	90	350	2	*1
21	32.8	35	21	71	90	380	2	*1
22	34	35	22	71	90	390	2	*1

\*1 Pin/O-Ring=1500A/B → P255

**15300M** 6-point Deep Sockets  
6-kant-Steckschlüssel, lang  
Douilles longues 6-pans

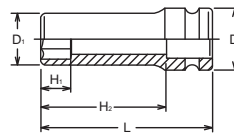

15310M (mm)	D <sub>1</sub> (mm)	D <sub>2</sub> (mm)	H <sub>1</sub> (mm)	H <sub>2</sub> (mm)	L (mm)	(g)	(pcs.)	
14	24	35	14	71	90	295	2	*1
17	27.8	35	17	71	90	325	2	*1
19	30.3	35	19	71	90	350	2	*1
21	32.8	35	21	71	90	380	2	*1
22	34	35	22	71	90	390	2	*1

\*1 Pin/O-Ring=1500A/B → P255

**15310M** Surface Drive Sockets, deep  
Surface Drive Steckschlüssel, lang  
Douilles longues, Surface Drive

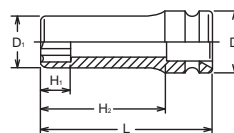

Impact Sockets  
Impact Steckschlüssel  
Douilles Impact

# 5/8"

Z-SERIES  
HAND  
TITANIUM  
SCREWDRIVERS ACCESSORIES  
IMPACT  
SLEEVE-DRIVE  
PROTECTOR  
INDUSTRIAL  
AUTOMOTIVE  
MOTORCYCLE  
CONSTRUCTION  
SPARE PART

**15555AL** Adaptor (Quick Release)  
Schnellwechsel-Verbindungsstück (Quick Release)  
Adaptateur (Quick Release) ⚠

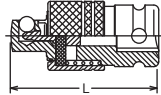

	L (mm)	(g)	(pce.)	
<b>15555AL</b>	70	310	1	*1

\*1 Pin/O-Ring=1500A/B → P255

**Lock & Quick Release**

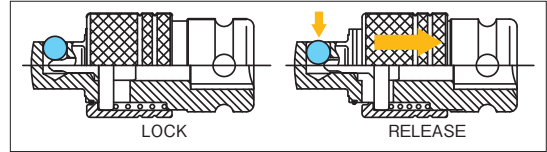

⚠ You may not hold the sliding part while moving to avoid heating up by friction and reduction by wear.

**15770** Universal Joint  
Gelenk-Einsatz  
Joint articulé

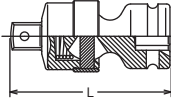

	L (mm)	(g)	(pce.)	
<b>15770</b>	88	420	1	*1

\*1 Pin/O-Ring=1500A/B → P255

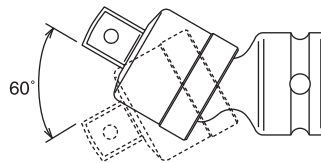

Our ball joints are spring-loaded and can therefore be adjusted to an angle of max. 30°.

Unsere Kugelgelenke sind federbelastet dadurch sind sie auf einen Winkel von max 30° einstellbar.

Nos joints à rotule sont à ressort et peuvent donc être réglés jusqu'à un angle de 30° maximum.

**15544A-P** Adaptor  
Verbindungsstück  
Réducteur No Warranty  
Keine Garantie  
Sans Garantie ⚠

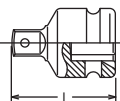

	(sq.)	(sq.)	L (mm)	(g)	(pce.)	
<b>15544A-P</b>	5/8"	1/2"	46	165	1	*1

\*1 Pin/O-Ring=1500A/B → P255

⚠ Adapting down from bigger square drive to smaller square drive may lead to excessive torque load and possibly cause breakage. Always stay within safe torque of the smaller square drive.

Die mit ⚠ gekennzeichneten Artikel können bei Überbelastung zu Bruch gehen. Aus Gründen Ihrer eigenen Sicherheit sollten die betreffenden Werkzeuge nie ruckartig, sondern nach und nach belastet werden, um Bruch und damit verbundene mögliche Verletzungen zu vermeiden.

Il est possible d'appliquer aux articles marqués ⚠ des couples de serrage susceptibles d'occasionner leur rupture. Pour votre propre sécurité, veuillez toujours appliquer la charge d'une manière uniforme et progressive. Ceci pour éviter ruptures et accidents.

**15566A** Adaptor  
Verbindungsstück  
Augmentateur

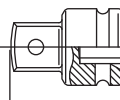

	(sq.)	(sq.)	L (mm)	(g)	(pce.)	
<b>15566A</b>	5/8"	3/4"	48	200	1	*1

\*1 Pin/O-Ring=1500A/B → P255

# 3/4"

## Impact Sockets Impact Steckschlüssel Douilles Impact

16400M (mm)	D <sub>1</sub> (mm)	D <sub>2</sub> (mm)	H (mm)	L (mm)	(g)	(pcs.)	
16	28.8	44	11	50	367	5	*1
17	30	44	12	50	355	5	*1
18	31.3	44	13	50	372	5	*1
19	32.5	44	13	50	360	5	*1
20	33.8	44	14	50	375	5	*1
21	35	44	15	50	374	5	*1
22	36.3	44	15	50	373	5	*1
23	37.5	44	16	50	373	5	*1
24	38.8	44	16	50	370	5	*1
25	40	44	16	50	374	5	*1
26	41.3	44	16	50	378	5	*1
27	42.5	44	16	50	375	5	*1
28	43.8	44	16	50	383	5	*1
29	45	44	18	53	412	5	*1
30	46.3	44	18	53	410	5	*1
31	47.5	44	18	53	426	5	*1
32	48.8	44	19	53	428	5	*1
33	50	44	20	55	470	5	*1
34	51.3	44	20	55	490	5	*1
35	52.5	44	20	55	494	5	*1
36	53.8	44	20	55	498	5	*1
37	55	44	20	55	526	2	*1
38	56.3	44	20	57	558	2	*1
39	57.5	44	20	57	579	2	*1
40	58.8	44	20	57	598	2	*1
41	60	44	22	57	572	2	*1
42	61.3	44	22	57	617	2	*1
43	62.5	44	23	62	720	2	*1
44	63.8	44	23	62	761	2	*1
45	65	44	23	62	757	2	*1
46	66.3	44	23	62	755	2	*1
47	67.5	54	23	62	805	2	*2
48	68.8	54	23	62	940	2	*2
49	70	54	23	62	912	2	*2
50	71.3	54	30	62	930	2	*2
52	73.8	54	29	62	1011	2	*2
54	76.3	54	29	62	1035	2	*2
55	77.5	54	29	62	1056	2	*2
56	78.8	54	29	62	1091	2	*2
57	80	54	32	65	1126	2	*2
58	81.3	54	31	65	1163	2	*2
59	82.5	54	31	65	1185	2	*2
60	83.8	54	31	65	1215	2	*2
65	90	54	30	65	1325	2	*2
70	96.3	54	34	70	1570	1	*2

\*1 C-Ring=1600C, Pin/O-Ring=1601A/B → P254-255  
 \*2 C-Ring=1801C, Pin/O-Ring=1602A/B

16405M (mm)	D <sub>1</sub> (mm)	D <sub>2</sub> (mm)	H (mm)	L (mm)	(g)	(pcs.)	
17	30	44	12	50	355	5	*1
18	31.3	44	13	50	372	5	*1
19	32.5	44	13	50	360	5	*1
20	33.8	44	14	50	375	5	*1
21	35	44	15	50	374	5	*1
22	36.3	44	15	50	373	5	*1
23	37.5	44	16	50	373	5	*1
24	38.8	44	16	50	370	5	*1
25	40	44	16	50	374	5	*1
26	41.3	44	16	50	378	5	*1
27	42.5	44	16	50	375	5	*1
28	43.8	44	16	50	383	5	*1
29	45	44	18	53	412	5	*1
30	46.3	44	18	53	410	5	*1
32	48.8	44	19	53	428	5	*1
33	50	44	20	55	470	5	*1
34	51.3	44	20	55	490	5	*1
36	53.8	44	20	55	498	5	*1
38	56.3	44	20	57	558	2	*1
41	60	44	22	57	572	2	*1
42	61.3	44	22	57	617	2	*1
46	66.3	44	23	62	755	2	*1
50	71.3	54	30	62	930	2	*2
52	73.8	54	29	62	1011	2	*2
55	77.5	54	29	62	1056	2	*2
60	83.8	54	31	65	1215	2	*2
65	90	54	30	65	1325	2	*2

\*1 C-Ring=1600C, Pin/O-Ring=1601A/B → P254-255  
 \*2 C-Ring=1801C, Pin/O-Ring=1602A/B



### 16400M / 16400A

6-point Sockets  
6-kant Steckschlüssel  
Douilles 6-pans

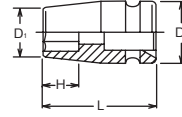

16400A (inch)	D <sub>1</sub> (mm)	D <sub>2</sub> (mm)	H (mm)	L (mm)	(g)	(pcs.)	
5/8	28.8	44	11	50	366	5	*1
11/16	30	44	12	50	355	5	*1
3/4	32.5	44	13	50	360	5	*1
13/16	35	44	15	50	374	5	*1
7/8	36.3	44	15	50	373	5	*1
15/16	38.8	44	16	50	370	5	*1
1	40	44	16	50	374	5	*1
1. 1/16	42.5	44	16	50	375	5	*1
1. 1/8	45	44	18	53	412	5	*1
1. 3/16	46.3	44	18	53	410	5	*1
1. 1/4	48.8	44	19	53	428	5	*1
1. 5/16	51.3	44	20	55	490	5	*1
1. 3/8	52.5	44	20	55	494	5	*1
1. 7/16	55	44	20	55	526	2	*1
1. 1/2	56.3	44	20	57	558	2	*1
1. 9/16	58.8	44	20	57	598	2	*1
1. 5/8	60	44	22	57	572	2	*1
1.11/16	62.5	44	23	62	720	2	*1
1. 3/4	65	44	23	62	757	2	*1
1.13/16	66.3	44	23	62	755	2	*1
1. 7/8	68.8	54	23	62	940	2	*2
1.15/16	70	54	23	62	912	2	*2
2	72.5	54	30	62	969	2	*2
2. 1/16	73.8	54	29	62	1011	2	*2
2. 1/8	76.3	54	29	62	1035	2	*2
2. 3/16	77.5	54	29	62	1056	2	*2
2. 1/4	80	54	32	65	1126	2	*2
2. 5/16	81.3	54	31	65	1163	2	*2
2. 3/8	83.8	54	31	65	1215	2	*2

### 16405M / 16405A

12-point Sockets  
12-kant Steckschlüssel  
Douilles 12-pans

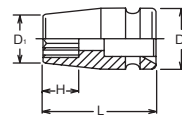

16405A (inch)	D <sub>1</sub> (mm)	D <sub>2</sub> (mm)	H (mm)	L (mm)	(g)	(pcs.)	
3/4	32.5	44	13	50	360	5	*1
13/16	35	44	15	50	374	5	*1
7/8	36.3	44	15	50	373	5	*1
15/16	38.8	44	16	50	370	5	*1
1	40	44	16	50	374	5	*1
1. 1/16	42.5	44	16	50	375	5	*1
1. 1/8	45	44	18	53	412	5	*1
1. 3/16	46.3	44	18	53	410	5	*1
1. 1/4	48.8	44	19	53	428	5	*1
1. 5/16	51.3	44	20	55	490	5	*1
1. 3/8	52.5	44	20	55	494	5	*1
1. 7/16	55	44	20	55	526	2	*1
1. 1/2	56.3	44	20	57	558	2	*1
1. 5/8	60	44	22	57	572	2	*1
1.11/16	62.5	44	23	62	720	2	*1
1. 3/4	65	44	23	62	757	2	*1
1. 7/8	68.8	54	23	62	940	2	*2
2	72.5	54	30	62	969	2	*2

Z-SERIES  
HAND  
TITANIUM  
SCREWDRIVERS ACCESSORIES  
IMPACT  
SLEEVE-DRIVE  
PROTECTOR  
INDUSTRIAL  
AUTOMOTIVE  
MOTORCYCLE  
CONSTRUCTION  
SPARE PART

## 16401M / 16401A

6-point Sockets, Thin Walled  
6-kant Steckschlüssel, dünnwandig  
Douilles à paroi mince, 6-pans

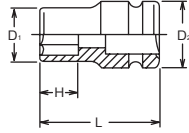

16401M (mm)	D <sub>1</sub> (mm)	D <sub>2</sub> (mm)	H (mm)	L (mm)	(g)	(pcs.)	
17	28	43	12	50	300	5	*1
18	29.3	43	13	50	300	5	*1
19	30.5	43	13	50	300	5	*1
20	31.8	43	14	50	302	5	*1
21	33	43	15	50	305	5	*1
22	34.3	43	15	50	310	5	*1
23	35.5	43	16	50	315	5	*1
24	36.8	43	16	50	325	5	*1
25	38	43	16	50	326	5	*1
26	39.3	43	16	50	330	5	*1
27	40.5	43	16	50	340	5	*1
28	41.8	43	16	50	345	5	*1
29	43	43	18	53	355	5	*1
30	44.3	43	18	53	365	5	*1
31	45.5	43	18	53	375	5	*1
32	46.8	43	19	53	385	5	*1
33	48	43	20	55	395	5	*1
34	49.3	43	20	55	420	5	*1
35	50.5	43	20	55	430	5	*1
36	51.8	43	20	55	440	5	*1
37	53	43	20	55	460	2	*1
38	54.3	43	20	57	472	2	*1
40	56.8	43	20	57	525	2	*1
41	58	43	22	57	555	2	*1
42	59.3	43	22	57	565	2	*1
43	60.5	43	23	62	662	2	*1
44	61.8	43	23	62	670	2	*1
45	63	43	23	62	700	2	*1
46	64.3	43	23	62	710	2	*1

\*1 C-Ring=1600C, Pin/O-Ring=1601A/B → P254-255

16401A (inch)	D <sub>1</sub> (mm)	D <sub>2</sub> (mm)	H (mm)	L (mm)	(g)	(pcs.)	
11/16	28	43	12	50	300	5	*1
3/4	30.5	43	13	50	300	5	*1
13/16	33	43	15	50	305	5	*1
7/8	34.3	43	15	50	310	5	*1
15/16	36.8	43	16	50	325	5	*1
1	38	43	16	50	326	5	*1
1. 1/16	40.5	43	16	50	340	5	*1
1. 1/8	43	43	18	53	355	5	*1
1. 3/16	44.3	43	18	53	365	5	*1
1. 1/4	46.8	43	19	53	385	5	*1
1. 5/16	49.3	43	20	55	437	5	*1
1. 3/8	50.5	43	20	55	430	5	*1
1. 7/16	53	43	20	55	460	2	*1
1. 1/2	54.3	43	20	57	472	2	*1
1. 9/16	56.8	43	20	57	525	2	*1
1. 5/8	58	43	22	57	555	2	*1
1.13/16	64.3	43	23	62	710	2	*1
1. 7/8	66.8	53	23	62	868	2	*2

\*1 C-Ring=1600C, Pin/O-Ring=1601A/B → P254-255

## 16410M

Surface Drive Sockets  
Surface Drive Steckschlüssel  
Douilles, Surface Drive

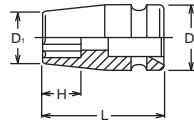

16410M (mm)	D <sub>1</sub> (mm)	D <sub>2</sub> (mm)	H (mm)	L (mm)	(g)	(pcs.)	
16	28.8	44	11	50	367	5	*1
17	30	44	12	50	355	5	*1
18	31.3	44	13	50	372	5	*1
19	32.5	44	13	50	360	5	*1
21	35	44	15	50	374	5	*1
22	36.3	44	15	50	373	5	*1
24	38.8	44	16	50	370	5	*1
27	42.5	44	16	50	375	5	*1
30	46.3	44	18	53	410	5	*1
32	48.8	44	19	53	428	5	*1
33	50	44	20	55	470	5	*1
36	53.8	44	20	55	498	5	*1

\*1 C-Ring=1600C, Pin/O-Ring=1601A/B → P254-255



# 3/4"

Impact Sockets  
Impact Steckschlüssel  
Douilles Impact

16425 (E)	D <sub>1</sub> (mm)	D <sub>2</sub> (mm)	H (mm)	L (mm)	(g)	(pcs.)	
E18	26.3	44	13	50	355	5	*1
E20	28.8	44	14.4	50	370	5	*1
E22	31.3	44	15.5	50	390	5	*1
E24	32.5	44	17	50	390	5	*1
E26	35	44	18.8	60	460	5	*1
E28	36.3	44	25.2	60	465	5	*1
E30	38.8	44	25.2	60	480	5	*1
E32	41.3	44	25.2	60	480	5	*1

\*1 C-Ring=1600C, Pin/O-Ring=1601A/B → P254-255

## 16425 TORX® Sockets TORX® Steckschlüssel Douilles TORX®

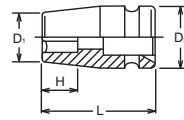

### TORX® (E)

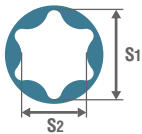

E	E4	E5	E6	E7	E8	E10	E11	E12	E14	E16	E18	E20	E22	E24	E26	E28	E30	E32
S <sub>1</sub> (ref. mm)	3.7	4.6	5.6	6.1	7.4	9.3	9.9	11.0	12.8	14.6	16.5	18.3	20.1	22.0	23.7	25.5	27.3	29.0
S <sub>2</sub> (ref. mm)	2.7	3.3	4.0	4.3	5.3	6.8	7.1	7.9	9.2	10.5	11.9	13.2	14.8	15.7	17.5	18.3	20.0	21.3

16425 (EPL)	D <sub>1</sub> (mm)	D <sub>2</sub> (mm)	H (mm)	L (mm)	(g)	(pcs.)	
24EPL	32.5	44	12.2	55	427	5	*1
32EPL	40	44	16.1	62	488	2	*1

\*1 C-Ring=1600C, Pin/O-Ring=1601A/B → P254-255

## 16425-EPL TORXPLUS® Sockets TORXPLUS® Steckschlüssel Douilles TORXPLUS®

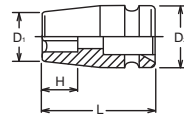

### TORXplus® (EP/EPL)

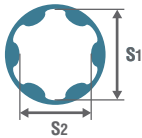

EP/EPL	8EP	10EP	12EP	14EP	16EP	18EP	20EP	22EP	24EP	26EP	28EP	30EP	32EP
S <sub>1</sub> (ref. mm)	7.4	9.3	11.0	12.8	14.6	16.5	18.3	20.1	22.0	23.7	25.5	27.3	29.0
S <sub>2</sub> (ref. mm)	5.3	6.8	7.9	9.2	10.5	11.9	13.2	14.8	15.7	17.5	18.3	20.0	21.3



# TORXplus®

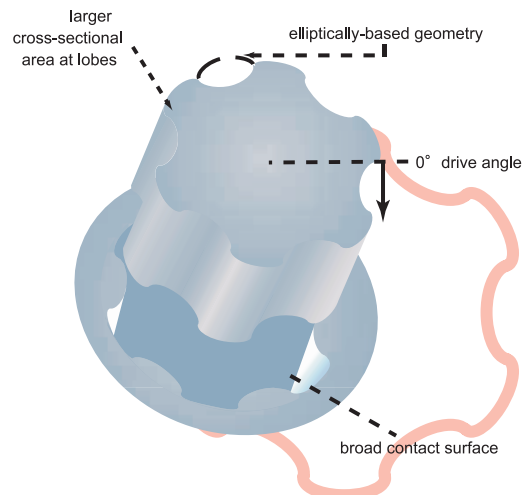
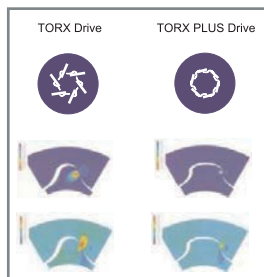
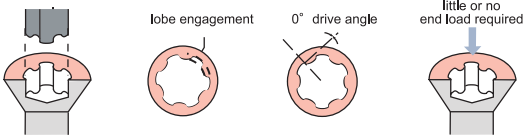

Impact Sockets  
Impact Steckschlüssel 3/4"  
Douilles Impact

**16301X** ○ 6-point Semi-Deep Sockets, Thin Walled  
6-kant Steckschlüssel mittel lang, dünnwandig  
Douilles à paroi mince semi-longues, 6-pans

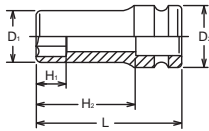

16301X (mm)	D <sub>1</sub> (mm)	D <sub>2</sub> (mm)	H <sub>1</sub> (mm)	H <sub>2</sub> (mm)	L (mm)	(g)	(pcs.)	
17	28	43	17	49	75	370	2	*1
18	29.3	43	18	49	75	380	2	*1
19	30.5	43	19	49	75	393	2	*1
20	31.8	43	20	49	75	400	2	*1
21	33	43	21	49	75	408	2	*1
22	34.3	43	22	49	75	418	2	*1
23	35.5	43	23	49	75	425	2	*1
24	36.8	43	24	49	75	435	2	*1
25	38	43	25	49	75	449	2	*1
26	39.3	43	26	49	75	455	2	*1
27	40.5	43	27	48	75	464	2	*1
28	41.8	43	28	48	75	479	2	*1
29	43	43	29	48	75	489	2	*1
30	44.3	43	30	48	75	506	2	*1
31	45.5	43	31	47	75	518	2	*1
32	46.8	43	32	47	75	535	2	*1
33	48	43	33	47	75	550	2	*1
35	50.5	43	35	46	75	585	2	*1
36	51.8	43	36	46	75	603	2	*1
37	53	43	37	46	75	645	2	*1
38	54.3	43	38	50	80	691	2	*1
40	56.8	43	38	50	80	725	2	*1
41	58	43	38	49	80	755	2	*1
46	64.3	43	38	48	80	808	2	*1

\*1 C-Ring=1600C, Pin/O-Ring=1601A/B → P254-255

**16300M / 16300A** ○ 6-point Sockets, deep  
6-kant Steckschlüssel, lang  
Douilles longues, 6-pans

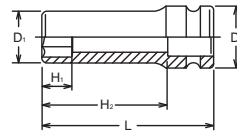

16300M (mm)	D <sub>1</sub> (mm)	D <sub>2</sub> (mm)	H <sub>1</sub> (mm)	H <sub>2</sub> (mm)	L (mm)	(g)	(pcs.)	
14	26.3	44	14	74	100	497	2	*1
16	28.8	44	16	74	100	524	2	*1
17	30	44	17	74	100	544	2	*1
18	31.3	44	18	74	100	642	2	*1
19	32.5	44	19	74	100	655	2	*1
20	33.8	44	20	74	100	680	2	*1
21	35	44	21	74	100	700	2	*1
22	36.3	44	22	74	100	700	2	*1
23	37.5	44	23	74	100	720	2	*1
24	38.8	44	24	74	100	705	2	*1
25	40	44	25	74	100	715	2	*1
26	41.3	44	26	74	100	710	2	*1
27	42.5	44	27	73	100	710	2	*1
28	43.8	44	28	73	100	800	2	*1
29	45	44	29	73	100	835	2	*1
30	46.3	44	30	73	100	840	2	*1
31	47.5	44	31	72	100	815	2	*1
32	48.8	44	32	72	100	875	2	*1
33	50	44	33	72	100	920	2	*1
34	51.3	44	34	72	100	950	2	*1
35	52.5	44	35	71	100	980	2	*1
36	53.8	44	36	71	100	960	2	*1
37	55	44	37	71	100	970	2	*1
38	56.3	44	38	70	100	990	2	*1
40	58.8	44	38	70	100	1060	2	*1
41	60	44	38	69	100	1120	2	*1
42	61.3	44	38	69	100	1153	2	*1
43	62.5	44	38	69	100	1200	2	*1
44	63.8	44	38	68	100	1220	2	*1
46	66.3	44	38	68	100	1305	2	*1
48	68.8	54	38	68	100	1480	2	*2
50	71.3	54	61	–	100	1469	2	*2
55	77.5	54	59	–	100	1620	2	*2
60	83.8	54	56	–	100	1835	2	*2

\*1 C-Ring=1600C, Pin/O-Ring=1601A/B  
\*2 C-Ring=1801C, Pin/O-Ring=1602A/B → P254-255

16300A (inch)	D <sub>1</sub> (mm)	D <sub>2</sub> (mm)	H <sub>1</sub> (mm)	H <sub>2</sub> (mm)	L (mm)	(g)	(pcs.)	
3/4	32.5	44	19	74	100	655	2	*1
13/16	35	44	21	74	100	700	2	*1
7/8	36.3	44	22	74	100	700	2	*1
15/16	38.8	44	24	74	100	705	2	*1
1	40	44	25	74	100	715	2	*1
1. 1/16	42.5	44	27	73	100	765	2	*1
1. 1/8	45	44	29	73	100	835	2	*1
1. 3/16	46.3	44	30	73	100	840	2	*1
1. 1/4	48.8	44	32	72	100	875	2	*1
1. 5/16	51.3	44	34	72	100	950	2	*1
1. 3/8	52.5	44	35	71	100	980	2	*1
1. 7/16	55	44	37	71	100	970	2	*1
1. 1/2	56.3	44	38	70	100	990	2	*1
1. 9/16	58.8	44	38	70	100	1060	2	*1
1. 5/8	60	44	38	69	100	1120	2	*1
1.11/16	62.5	44	38	69	100	1200	2	*1
1. 3/4	65	44	38	68	100	1284	2	*1
1.13/16	66.3	44	38	68	100	1305	2	*1
1. 7/8	68.8	54	38	67	100	1561	2	*2
2	72.5	54	60	–	100	1516	2	*2

\*1 C-Ring=1600C, Pin/O-Ring=1601A/B → P254-255  
\*2 C-Ring=1801C, Pin/O-Ring=1602A/B

### 16301M / 16301A

6-point Deep Sockets, Thin Walled  
6-kant Steckschlüssel, dünnwandig  
Douilles à paroi mince longues, 6-pans

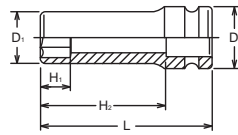

16301M (mm)	D <sub>1</sub> (mm)	D <sub>2</sub> (mm)	H <sub>1</sub> (mm)	H <sub>2</sub> (mm)	L (mm)	⚖ (g)	📦 (pcs.)	⚡
16	26.8	43	16	74	100	435	2	*1
17	28	43	17	74	100	470	2	*1
18	29.3	43	18	74	100	475	2	*1
19	30.5	43	19	74	100	480	2	*1
20	31.8	43	20	74	100	491	2	*1
21	33	43	21	74	100	505	2	*1
22	34.3	43	22	74	100	528	2	*1
23	35.5	43	23	74	100	542	2	*1
24	36.8	43	24	74	100	560	2	*1
25	38	43	25	74	100	581	2	*1
26	39.3	43	26	74	100	600	2	*1
27	40.5	43	27	73	100	610	2	*1
28	41.8	43	28	73	100	639	2	*1
29	43	43	29	73	100	650	2	*1
30	44.3	43	30	73	100	670	2	*1
31	45.5	43	31	72	100	690	2	*1
32	46.8	43	32	72	100	715	2	*1
33	48	43	33	72	100	750	2	*1
34	49.3	43	34	72	100	772	2	*1
35	50.5	43	35	71	100	785	2	*1
36	51.8	43	36	71	100	830	2	*1
37	53	43	37	71	100	850	2	*1
38	54.3	43	38	70	100	885	2	*1
40	56.8	43	38	70	100	925	2	*1
41	58	43	38	69	100	970	2	*1
42	59.3	43	38	69	100	990	2	*1
46	64.3	43	38	68	100	1150	2	*1
50	69.2	53	62	-	100	1328	2	*2

\*1 C-Ring=1600C, Pin/O-Ring=1601A/B  
\*2 C-Ring=1801C, Pin/O-Ring=1602A/B



16301A (inch)	D <sub>1</sub> (mm)	D <sub>2</sub> (mm)	H <sub>1</sub> (mm)	H <sub>2</sub> (mm)	L (mm)	⚖ (g)	📦 (pcs.)	⚡
11/16	28	43	17	74	100	470	2	*1
3/4	30.5	43	19	74	100	480	2	*1
13/16	33	43	21	74	100	505	2	*1
7/8	34.3	43	22	74	100	528	2	*1
15/16	36.8	43	24	74	100	560	2	*1
1	38	43	25	74	100	581	2	*1
1. 1/16	40.5	43	27	73	100	610	2	*1
1. 1/8	43	43	29	73	100	650	2	*1
1. 3/16	44.3	43	30	73	100	670	2	*1
1. 1/4	46.8	43	32	72	100	715	2	*1
1. 5/16	49.3	43	34	72	100	790	2	*1
1. 3/8	50.5	43	35	71	100	785	2	*1
1. 7/16	53	43	37	71	100	850	2	*1
1. 1/2	54.3	43	38	70	100	885	2	*1
1. 9/16	56.8	43	38	70	100	925	2	*1
1. 5/8	58	43	38	69	100	970	2	*1
1.13/16	64.3	43	38	68	100	1150	2	*1

\*1 C-Ring=1600C, Pin/O-Ring=1601A/B → P254-255

16305M (mm)	D <sub>1</sub> (mm)	D <sub>2</sub> (mm)	H <sub>1</sub> (mm)	H <sub>2</sub> (mm)	L (mm)	⚖ (g)	📦 (pcs.)	⚡
14	26.3	44	14	74	100	500	2	*1
16	28.8	44	16	74	100	522	2	*1
17	30	44	17	74	100	544	2	*1
18	31.3	44	18	74	100	600	2	*1
19	32.5	44	19	74	100	655	2	*1
21	35	44	21	74	100	700	2	*1
22	36.3	44	22	74	100	700	2	*1
23	37.5	44	23	74	100	720	2	*1
24	38.8	44	24	74	100	715	2	*1
26	41.3	44	26	74	100	760	2	*1
27	42.5	44	27	73	100	765	2	*1
28	43.8	44	28	73	100	800	2	*1
29	45	44	29	73	100	835	2	*1
30	46.3	44	30	73	100	840	2	*1
32	48.8	44	32	72	100	875	2	*1
33	50	44	33	72	100	920	2	*1
34	51.3	44	34	72	100	950	2	*1
35	52.5	44	35	71	100	980	2	*1
36	53.8	44	36	71	100	960	2	*1
38	56.3	44	38	70	100	990	2	*1
41	60	44	38	69	100	1120	2	*1
46	66.3	44	38	68	100	1305	2	*1
50	71.3	54	61	-	100	1469	2	*2

\*1 C-Ring=1600C, Pin/O-Ring=1601A/B  
\*2 C-Ring=1801C, Pin/O-Ring=1602A/B



### 16305M

12-point Sockets, deep  
12-kant Steckschlüssel, lang  
Douilles longues, 12-pans

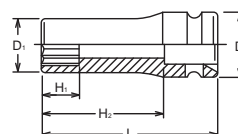

# Impact Sockets Impact Steckschlüssel 3/4"

**16310M**  Surface Drive Sockets, deep  
Surface Drive Steckschlüssel, lang  
Douilles longues, Surface Drive

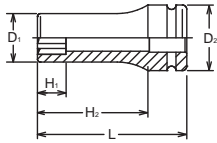

16310M	D <sub>1</sub>	D <sub>2</sub>	H <sub>1</sub>	H <sub>2</sub>	L	(g)	(pcs.)	
(mm)	(mm)	(mm)	(mm)	(mm)	(mm)			
16	28.8	44	16	74	100	524	2	*1
17	30	44	17	74	100	544	2	*1
18	31.3	44	18	74	100	642	2	*1
19	32.5	44	19	74	100	655	2	*1
21	35	44	21	74	100	700	2	*1
22	36.3	44	22	74	100	700	2	*1
24	38.8	44	24	74	100	705	2	*1
27	42.5	44	27	73	100	710	2	*1
30	46.3	44	30	73	100	840	2	*1
32	48.8	44	32	72	100	875	2	*1
33	50	44	33	72	100	920	2	*1
36	53.8	44	34	71	100	960	2	*1

\*1 C-Ring=1600C, Pin/O-Ring=1601A/B → P254-255

## SURFACE DRIVE

Surface drive sockets are designed to retain contact with the flat sides of the nut in order to transmit higher torque and reduce nut wear. These sockets are ideal for using on polished nuts, aluminum nuts and nuts with worn out points.

Das Profil unserer Surface-Drive Steckschlüssel greift die Schraube an deren Flächen. Dies sichert eine höhere Kraftübertragung und verhindert ein Durchrutschen des Steckschlüssels. Diese Steckschlüssel eignen sich besonders für polierte Schrauben, Aluminium Schrauben und Schrauben bei denen die Ecken bereits abgerundet sind.

Notre profil Surface Drive assure le contact entre la douille et les plats de l'écrou. Ceci réduit l'usure et permet la transmission d'un couple plus élevé. C'est une solution idéale pour les écrous polies, celles en aluminium ou arrondies.

**16325**  TORX® Deep Sockets  
TORX® Steckschlüssel, lang  
Douilles longues TORX®

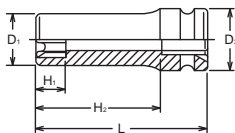

16325	D <sub>1</sub>	D <sub>2</sub>	H <sub>1</sub>	H <sub>2</sub>	L	(g)	(pcs.)	
(E)	(mm)	(mm)	(mm)	(mm)	(mm)			
E18	26.3	44	13	74	100	520	2	*1
E20	28.8	44	14.4	74	100	560	2	*1
E22	31.3	44	15.5	74	100	600	2	*1
E24	32.5	44	17	74	100	630	2	*1
E26	35.0	44	18.8	74	100	660	2	*1
E28	36.3	44	25.2	74	100	670	2	*1
E30	38.8	44	25.2	75	100	730	2	*1
E32	41.3	44	25.2	75	100	777	2	*1

\*1 C-Ring=1600C, Pin/O-Ring=1601A/B → P254-255

TORX®  
(E)

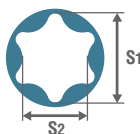

E	E4	E5	E6	E7	E8	E10	E11	E12	E14	E16	E18	E20	E22	E24	E26	E28	E30	E32
S <sub>1</sub> (ref. mm)	3.7	4.6	5.6	6.1	7.4	9.3	9.9	11.0	12.8	14.6	16.5	18.3	20.1	22.0	23.7	25.5	27.3	29.0
S <sub>2</sub> (ref. mm)	2.7	3.3	4.0	4.3	5.3	6.8	7.1	7.9	9.2	10.5	11.9	13.2	14.8	15.7	17.5	18.3	20.0	21.3

# 3/4"

Impact Sockets  
Impact Steckschlüssel  
Douilles Impact

	D <sub>1</sub> (mm)	D <sub>2</sub> (mm)	H (mm)	L (mm)	(g)	(pcs.)	⚡
<b>16106</b>	32	44	16	52	370	2	*1

\*1 C-Ring=1600C, Pin/O-Ring=1601A/B → P254-255

16106-SC

Replacement Screw : M6x10, 3mm

107-16 (mm)	L (mm)	L (mm)	L=40 (g)	L=100 (g)	(pcs.)
10	40	100	46	122	10
12	40	100	52	146	10
13	40	-	56	-	10
14	40	100	60	166	10
16	40	-	69	-	10
17	40	100	73	193	10
18	40	-	78	-	10
19	40	100	80	232	10
22	40	100	97	254	10

107-16 (inch)	L (mm)	(g)	(pcs.)
3/8	40	45	10
1/2	40	56	10
9/16	40	60	10
5/8	40	69	10
3/4	40	80	10

107-16 (T)	L (mm)	L (mm)	L=50 (g)	L=100 (g)	(pcs.)
T55	50	100	57	108	10
T60	50	100	64	130	10
T70	50	100	73	159	10

107-16 (IP)	L (mm)	(g)	(pcs.)
55IP	50	57	10
60IP	50	64	10
70IP	50	73	10

107-16 (XZN)	L (mm)	L (mm)	L=60 (g)	L=100 (g)	(pcs.)
M14	60	100	83	131	10
M16	60	100	93	161	10
M18	60	100	103	177	10

16106-16 (mm)	D (mm)	H (mm)	L (mm)	(g)	(pcs.)	⚡
10	44	24	76	416	2	*1
12	44	24	76	422	2	*1
13	44	24	76	426	2	*1
14	44	24	76	430	2	*1
16	44	24	76	439	2	*1
17	44	24	76	443	2	*1
18	44	24	76	448	2	*1
19	44	24	76	450	2	*1
22	44	24	76	473	2	*1

16106-16 (inch)	D (mm)	H (mm)	L (mm)	(g)	(pcs.)	⚡
1/2	44	24	76	426	2	*1
9/16	44	24	76	430	2	*1
5/8	44	24	76	439	2	*1
3/4	44	24	76	450	2	*1

\*1 C-Ring=1600C, Pin/O-Ring=1601A/B → P254-255

## 16106 ○ Bit Holder Klingenhalter Porte-embout

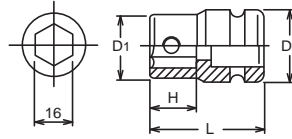

## 107-16 ● Bits for Inhex Screws Klingen für Innensechskant-Schrauben Embouts pour vis 6-pans males creux

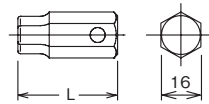

## 107-16 (T) ● TORX® Bits TORX® Klingen Embouts, TORX®

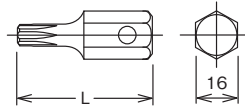

## 107-16 (IP) ● TORXPLUS® Bits TORXPLUS® Klingen Embouts TORXPLUS®

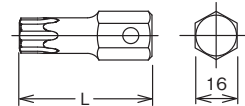

## 107-16 (XZN) ● Bits XZN Klingen XZN Embouts de vissage, XZN

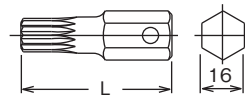

## 16106-16 ● Bit Holder complete with Bit, Inhex Klingenhalter komplett mit Klinge, Innensechskant Porte embouts avec bit 6-pans creux

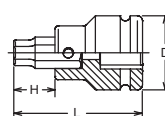

# Impact Sockets Impact Steckschlüssel Douilles Impact

# 3/4"

Z-SERIES  
HAND  
TITANIUM  
SCREWDRIVERS ACCESSORIES  
IMPACT  
SLEEVE-DRIVE  
PROTECTOR  
INDUSTRIAL  
AUTOMOTIVE  
MOTORCYCLE  
CONSTRUCTION  
SPARE PART

## 16107-22

Bit Holder complete with Bit  
Klingenhalter, komplett mit Klinge  
Porte embouts avec bit

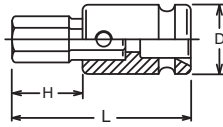

16107-22 (mm)	D (mm)	H (mm)	L (mm)	(g)	(pcs.)	
19	44	28	88	670	2	*1
22	44	28	88	692	2	*1
24	44	28	88	706	2	*1
27	44	28	88	730	2	*1
30	44	28	88	757	2	*1
32	44	28	93	783	2	*1

\*1 C-Ring=1600C, Pin/O-Ring=1601A/B → P254-255

## 16107

Bit Holder  
Klingenhalter  
Porte embouts

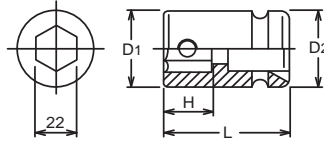

	D <sub>1</sub> (mm)	D <sub>2</sub> (mm)	H (mm)	L (mm)	(g)	(pcs.)	
16107	44	44	22	60	530	2	*1

\*1 C-Ring=1600C, Pin/O-Ring=1601A/B → P254-255

### 16107-SC

Replacement Screw : M8x14, 4mm

## 107-22

Bits for Inhex Screws  
Klingen für Innensechskant-Schrauben  
Embouts pour vis 6-pans males creux

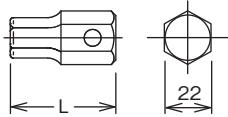

107-22 (mm)	L (mm)	(g)	(pcs.)
17	50	120	10
19	50	140	10
22	50	162	10
24	50	176	10
27	50	200	10
30	50	227	10
32	55	243	10

107-22 (inch)	L (mm)	(g)	(pcs.)
5/8	50	120	10
3/4	50	140	10
7/8	50	162	10
1	50	190	10
1. 1/4	55	243	10

## 107-22 (T)

TORX® Bits  
TORX® Klingen  
Embouts, TORX®

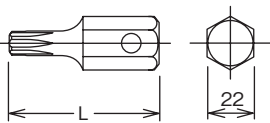

107-22 (T)	L (mm)	(g)	(pcs.)
T 70	60	125	10
T 80	60	141	10
T 90	60	155	10
T100	60	170	10

## 16760

Extension Bars  
Verlängerungen  
Rallonges

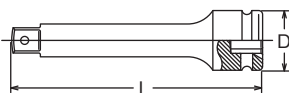

	D (mm)	L (mm)	(g)	(pcs.)	
16760-150	44	150	775	1	*1
16760-175	44	175	870	1	*1
16760-200	44	200	955	1	*1
16760-250	44	250	1150	1	*1
16760-330	44	330	1460	1	*1

\*1 C-Ring=1600C, Pin/O-Ring=1601A/B → P254-255

	L (mm)	(g)	(pcs.)	
16666AL	75	660	2	*1

\*1 C-Ring=1600C, Pin/O-Ring=1601A/B → P254-255

### Lock & Quick Release

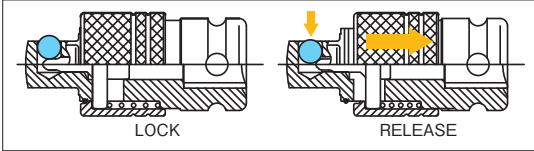

**⚠** You may not hold the sliding part while moving to avoid heating up by friction and reduction by wear.



LOCKING ADAPTOR

### 16666AL

Adaptor (Quick Release)  
Verbindungsstück (Quick Release)  
Adaptateur (Quick Release) **⚠**

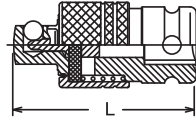

	L (mm)	(g)	(pce.)	
16770	106	790	1	*1
16771	95	720	1	*1

\*1 C-Ring=1600C, Pin/O-Ring=1601A/B → P254-255

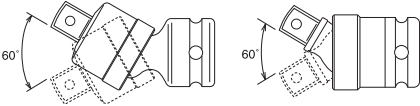

Our ball joints are spring-loaded and can therefore be adjusted to an angle of max. 30°.

Unsere Kugelgelenke sind federbelastet dadurch sind sie auf einen Winkel von max 30° einstellbar.

Nos joints à rotule sont à ressort et peuvent donc être réglés jusqu'à un angle de 30° maximum.

### 16770

Universal Joint  
Gelenk-Einsatz  
Joint articulé

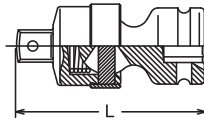

### 16771

Universal Joint  
Gelenk-Einsatz  
Joint articulé

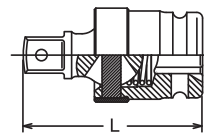

	TYPE	(sq.)	(sq.)	L (mm)	(g)	(pcs.)	
16644A-P	Pin	3/4"	1/2"	54	310	5	*1
16644A	Hole	3/4"	1/2"	54	310	5	*1

	(sq.)	(sq.)	L (mm)	(g)	(pcs.)	
16655A	3/4"	5/8"	55.5	336	5	*1

\*1 C-Ring=1600C, Pin/O-Ring=1601A/B → P254-255

**⚠** Adapting down from bigger square drive to smaller square drive may lead to excessive torque load and possibly cause breakage. Always stay within safe torque of the smaller square drive.

Die mit **⚠** gekennzeichneten Artikel können bei Überbelastung zu Bruch gehen. Aus Gründen Ihrer eigenen Sicherheit sollten die betreffenden Werkzeuge nie ruckartig, sondern nach und nach belastet werden, um Bruch und damit verbundene mögliche Verletzungen zu vermeiden.

Il est possible d'appliquer aux articles marqués **⚠** des couples de serrage susceptibles d'occasionner leur rupture. Pour votre propre sécurité, veuillez toujours appliquer la charge d'une manière uniforme et progressive. Ceci pour éviter ruptures et accidents.

	(sq.)	(sq.)	L (mm)	(g)	(pce.)	
16688A	3/4"	1"	62	435	1	*1
16688A-250	3/4"	1"	250	1400	1	*1
16688A-330	3/4"	1"	330	1880	1	*1

\*1 C-Ring=1600C, Pin/O-Ring=1601A/B → P254-255

### 16644A-P 16644A 16655A

Adaptors  
Verbindungsstücke  
Réducteurs  
No Warranty  
Keine Garantie  
Sans Garantie **⚠**

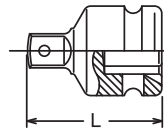

### 16688A

Adaptor  
Verbindungsstück  
Augmentateur

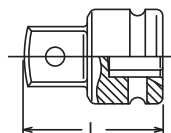

### 16688A-250 / -330

Adaptors  
Verbindungsstücke  
Réducteurs





Impact Sockets  
Impact Steckschlüssel 3/4"  
Douilles Impact

Z-SERIES  
HAND  
TITANIUM  
ACCESSORIES  
SCREWDRIVERS  
IMPACT  
SLEEVE-DRIVE  
PROTECTOR  
INDUSTRIAL  
AUTOMOTIVE  
MOTORCYCLE  
CONSTRUCTION  
SPARE PART

**16201M-00 / 16201A-00**  Socket Sets  
Steckschlüssel Sätze  
Jeux de clés à douilles





<b>16201M-00</b>	13 Pieces Set/△=6,800g
METAL CASE:W320xH110xT70mm	
Sockets	
	<b>16400M</b> 6-pt. Sockets 19, 21, 22, 23, 24, 26, 27, 30, 32, 33, 36, 38, 41

<b>16201A-00</b>	11 Pieces Set/△=6,000g
METAL CASE:W290xH120xT70mm	
Sockets	
	<b>16400A</b> 6-pt. Sockets 3/4, 7/8, 15/16, 1, 1.1/16, 1.1/8, 1.1/4, 1.5/16, 1.3/8, 1.7/16, 1.1/2

**16201M-01 / 16201A-01**  Socket Sets  
Steckschlüssel Sätze  
Jeux de clés à douilles 



<b>16201M-01</b>	13 Pieces Set/△=6,000g
METAL CASE:W320xH110xT70mm	
Sockets	
	<b>16401M</b> 6-pt. Sockets, Thin-walled 19, 21, 22, 23, 24, 26, 27, 30, 32, 33, 36, 38, 41

<b>16201A-01</b>	11 Pieces Set/△=5,400g
METAL CASE:W290xH120xT70mm	
Sockets	
	<b>16401A</b> 6-pt. Sockets, Thin-walled 3/4, 7/8, 15/16, 1, 1.1/16, 1.1/8, 1.1/4, 1.5/16, 1.3/8, 1.7/16, 1.1/2

**16245M**  Socket Sets  
Steckschlüssel Sätze  
Jeux de clés à douilles

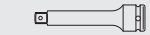
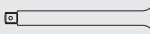

<b>16245M</b>	17 Pieces Set/△=12,000g
METAL CASE:W590xH127xT72mm	
Sockets	
	<b>16400M</b> 6-pt. Sockets 19, 21, 22, 24, 27, 29, 30, 32, 33, 35, 36, 38, 41, 46, 50
Accessories	
	<b>16760-175</b>
	<b>16760-330</b>





## 18400M / 18400A 6-point Sockets 6-kant Steckschlüssel Douilles 6-pans

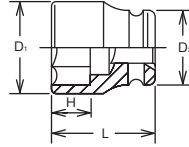

18400M (mm)	D <sub>1</sub> (mm)	D <sub>2</sub> (mm)	H (mm)	L (mm)	(g)	(pcs.)	
17	32.8	54	12	57	579	2	*1
18	34	54	13	57	586	2	*1
19	35.3	54	13	57	590	2	*1
21	37.8	54	15	57	605	2	*1
22	39	54	15	57	620	2	*1
23	40.3	54	16	57	615	2	*1
24	41.5	54	16	57	627	2	*1
25	42.8	54	16	57	620	2	*1
26	44	54	16	57	640	2	*1
27	45.3	54	16	57	627	2	*1
28	46.5	54	16	57	640	2	*1
29	47.8	54	18	57	657	2	*1
30	49	54	21	62	657	2	*1
31	50.3	54	21	62	687	2	*1
32	51.5	54	21	62	685	2	*1
33	52.8	54	21	62	685	2	*1
34	54	54	21	62	690	2	*1
35	55.3	54	21	62	710	2	*1
36	56.5	54	21	62	712	2	*1
37	57.8	54	21	62	735	2	*1
38	59	54	25	66	720	2	*1
39	60.3	54	25	66	820	2	*1
40	61.5	54	25	66	850	2	*1
41	62.8	54	25	66	850	2	*1
42	64	54	25	66	905	2	*1
43	65.3	54	27	68	977	2	*1
44	66.5	54	27	68	970	2	*1
45	67.8	54	27	68	963	2	*1
46	69	54	29	70	1010	2	*1
47	70.3	54	36	70	997	2	*1
48	71.5	54	35	70	990	2	*1
50	74	54	35	70	1065	2	*1
52	76.5	54	40	75	1185	2	*1
54	79	54	40	75	1252	2	*1
55	80.3	54	39	75	1260	2	*1
56	81.5	54	39	75	1277	2	*1
58	84	54	39	75	1340	2	*1
60	86.5	54	39	75	1400	2	*1
62	89	54	38	75	1410	2	*1
63	90.3	54	38	75	1383	2	*1
65	92.8	54	38	75	1630	2	*1
67	95.3	54	38	75	1580	2	*1
68	96.5	54	37	75	1583	1	*1
70	99	54	37	75	1625	1	*1
75	105.3	86	37	80	2675	1	*2
77	107.8	86	37	80	2890	1	*2
80	111.5	86	41	85	2996	1	*2
85	117.8	86	37	90	3378	1	*2
90	124	86	40	95	3871	1	*2
95	130.3	86	43	100	4500	1	*2
100	136.5	86	47	105	5000	1	*2

\*1 C-Ring=1801C, Pin/O-Ring=1801A/B  
\*2 C-Ring=1802C, Pin/O-Ring=1802A/B

18400A (inch)	D <sub>1</sub> (mm)	D <sub>2</sub> (mm)	H (mm)	L (mm)	(g)	(pcs.)	
11/16	32.8	54	12	57	579	2	*1
3/4	35.3	54	13	57	590	2	*1
13/16	37.8	54	15	57	605	2	*1
7/8	39	54	15	57	620	2	*1
15/16	41.5	54	16	57	627	2	*1
1	42.8	54	16	57	620	2	*1
1. 1/16	45.3	54	16	57	627	2	*1
1. 1/8	47.8	54	18	57	657	2	*1
1. 3/16	49	54	21	62	657	2	*1
1. 1/4	51.5	54	21	62	685	2	*1
1. 5/16	54	54	21	62	690	2	*1
1. 3/8	55.3	54	21	62	710	2	*1
1. 7/16	57.8	54	21	62	735	2	*1
1. 1/2	59	54	25	66	720	2	*1
1. 9/16	61.5	54	25	66	850	2	*1
1. 5/8	62.8	54	25	66	850	2	*1
1.11/16	65.3	54	27	68	977	2	*1
1. 3/4	67.8	54	27	68	963	2	*1
1.13/16	69	54	29	70	1010	2	*1
1. 7/8	71.5	54	35	70	990	2	*1
1.15/16	72.8	54	35	70	1000	2	*1
2	75.3	54	35	70	1060	2	*1
2. 1/16	76.5	54	40	75	1185	2	*1
2. 1/8	79	54	40	75	1252	2	*1
2. 3/16	80.3	54	39	75	1260	2	*1
2. 1/4	82.8	54	39	75	1337	2	*1
2. 5/16	84	54	39	75	1340	2	*1
2. 3/8	86.5	54	39	75	1400	2	*1
2. 7/16	89	54	38	75	1410	2	*1
2. 1/2	91.5	54	38	75	1498	2	*1
2. 9/16	92.8	54	38	75	1630	2	*1
2. 5/8	95.3	54	38	75	1580	2	*1
2.11/16	96.5	54	37	75	1583	1	*1
2. 3/4	99	54	37	75	1625	1	*1
2.13/16	101.5	86	37	80	2705	1	*2
2. 7/8	102.8	86	38	80	2629	1	*2
2.15/16	105.3	86	37	80	2675	1	*2
3	106.5	86	37	80	2705	1	*2
3. 1/16	109	86	42	85	2967	1	*2
3. 1/8	111.5	86	41	85	2996	1	*2
3. 1/4	115.3	86	44	90	3328	1	*2
3. 3/8	119	86	36	90	3389	1	*2
3. 1/2	124	86	40	95	3871	1	*2
3. 3/4	130.3	86	43	100	4377	1	*2
3. 7/8	135.3	86	47	105	5000	1	*2
4	137.8	86	46	105	5152	1	*2

\*1 C-Ring=1801C, Pin/O-Ring=1801A/B   
\*2 C-Ring=1802C, Pin/O-Ring=1802A/B



Z-SERIES  
HAND  
TITANIUM  
ACCESSORIES  
IMPACT  
SLEEVE-DRIVE  
PROTECTOR  
INDUSTRIAL  
AUTOMOTIVE  
MOTORCYCLE  
CONSTRUCTION  
SPARE PART

**18405M / 18405A** 12-point Sockets  
12-kant Steckschlüssel  
Douilles 12-pans

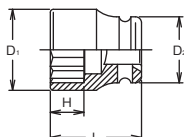

18405M (mm)	D <sub>1</sub> (mm)	D <sub>2</sub> (mm)	H (mm)	L (mm)	(g)	(pcs.)	
24	41.5	54	16	57	627	2	*1
27	45.3	54	16	57	607	2	*1
30	49	54	21	62	657	2	*1
32	51.5	54	21	62	685	2	*1
33	52.8	54	21	62	690	2	*1
35	55.3	54	21	62	690	2	*1
36	56.5	54	21	62	692	2	*1
38	59	54	25	66	700	2	*1
40	61.5	54	25	66	830	2	*1
41	62.8	54	25	66	905	2	*1
46	69	54	29	70	990	2	*1
50	74	54	35	70	1021	2	*1
55	80.3	54	39	75	1234	2	*1
56	81.5	54	39	75	1250	2	*1
60	86.5	54	39	75	1400	2	*1
65	92.8	54	38	75	1600	2	*1
70	99	54	37	75	1625	1	*1
75	105.3	86	37	80	2675	1	*2
80	111.5	86	41	85	2996	1	*2

18405A (inch)	D <sub>1</sub> (mm)	D <sub>2</sub> (mm)	H (mm)	L (mm)	(g)	(pcs.)	
3/4	35.3	54	13	57	590	2	*1
7/8	39	54	15	57	620	2	*1
1	42.8	54	16	57	620	2	*1
1. 1/8	47.8	54	18	57	660	2	*1
1. 3/16	49	54	21	62	660	2	*1
1. 1/4	51.5	54	21	62	690	2	*1
1. 3/8	55.3	54	21	62	710	2	*1
1. 7/16	57.8	54	21	62	735	2	*1
1. 1/2	59	54	25	66	720	2	*1
1. 3/4	67.8	54	27	68	970	2	*1
1.15/16	72.8	54	35	70	1000	2	*1

\*1 C-Ring=1801C, Pin/O-Ring=1801A/B → P254-255

**18401M / 18401A** 6-point Sockets, Thin Walled  
6-kant Steckschlüssel, dünnwandig  
Douilles à paroi mince, 6-pans

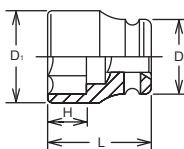

18401M (mm)	D <sub>1</sub> (mm)	D <sub>2</sub> (mm)	H (mm)	L (mm)	(g)	(pcs.)	
17	29.8	53	12	57	481	2	*1
18	31	53	13	57	488	2	*1
19	32.3	53	13	57	492	2	*1
20	33.5	53	14	57	505	2	*1
21	34.8	53	15	57	512	2	*1
22	36	53	15	57	520	2	*1
24	38.5	53	16	57	520	2	*1
26	41	53	16	57	533	2	*1
27	42.3	53	16	57	540	2	*1
29	44.8	53	18	57	560	2	*1
30	46	53	21	62	572	2	*1
32	48.5	53	21	62	600	2	*1
33	49.8	53	21	62	613	2	*1
35	52.3	53	21	62	630	2	*1
36	53.5	53	21	62	635	2	*1
38	56	53	25	66	705	2	*1
41	59.8	53	25	66	740	2	*1
42	61	53	25	66	803	2	*1
46	66	53	29	70	900	2	*1
47	67.3	53	36	70	915	2	*1
50	71	53	35	70	940	2	*1

18401A (inch)	D <sub>1</sub> (mm)	D <sub>2</sub> (mm)	H (mm)	L (mm)	(g)	(pcs.)	
11/16	29.8	53	12	57	481	2	*1
3/4	32.3	53	13	57	492	2	*1
13/16	34.8	53	15	57	512	2	*1
7/8	36	53	15	57	520	2	*1
15/16	38.5	53	16	57	520	2	*1
1. 1/16	42.3	53	16	57	540	2	*1
1. 3/16	46	53	21	62	572	2	*1
1. 1/4	48.5	53	21	62	600	2	*1
1. 3/8	52.3	53	21	62	630	2	*1
1. 1/2	56	53	25	66	705	2	*1
1. 5/8	59.8	53	25	66	740	2	*1
1.13/16	66	53	29	70	900	2	*1

\*1 C-Ring=1801C, Pin/O-Ring=1801A/B → P254-255

18410M (mm)	D <sub>1</sub> (mm)	D <sub>2</sub> (mm)	H (mm)	L (mm)	(g)	(pcs.)	⚠
24	41.5	54	16	57	627	2	*1
27	45.3	54	16	57	627	2	*1
30	49	54	21	62	657	2	*1
32	51.5	54	21	62	685	2	*1
33	52.8	54	21	62	685	2	*1
36	56.5	54	21	62	712	2	*1
41	62.8	54	25	66	850	2	*1

\*1 C-Ring=1801C, Pin/O-Ring=1801A/B → P254-255



## 18410M

Surface Drive Sockets  
Surface Drive Steckschlüssel  
Douilles, Surface Drive

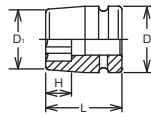

## 18405M (D)

Sockets for Cardan Shafts  
Steckschlüssel für Gelenkwellen  
Douilles pour arbres à cardan

No Warranty  
Keine Garantie  
Sans Garantie ⚠

18405M (D) (mm)	D <sub>1</sub> (mm)	D <sub>2</sub> (mm)	H (mm)	L (mm)	(g)	(pcs.)	⚠
50(D68)	68	54	35	70	890	2	*1
55(D76)	76	54	39	75	1130	2	*1
65(D87)	87	54	38	75	1344	2	*1

\*1 C-Ring=1801C, Pin/O-Ring=1801A/B → P254-255

Items in this catalogue marked ⚠ can be loaded to torque values which may cause breakage. In the interest of your own safety always apply load evenly and progressively to avoid breakage and possible injury.

Die mit ⚠ gekennzeichneten Artikel können bei Überbelastung zu Bruch gehen. Aus Gründen Ihrer eigenen Sicherheit sollten die betreffenden Werkzeuge nie ruckartig, sondern nach und nach belastet werden, um Bruch und damit verbundene mögliche Verletzungen zu vermeiden.

Il est possible d'appliquer aux articles marqués ⚠ des couples de serrage susceptibles d'occasionner leur rupture. Pour votre propre sécurité, veuillez toujours appliquer la charge d'une manière uniforme et progressive. Ceci pour éviter ruptures et accidents.

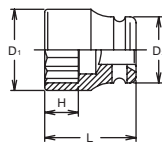

# Impact Sockets

## Impact Steckschlüssel

### Douilles Impact



### 18301X



6-point Semi-Deep Sockets, Thin Walled  
6-kant Steckschlüssel mittel lang, dünnwandig  
Douilles à paroi mince semi-longues, 6-pans

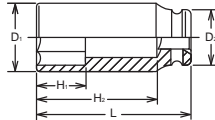

18301X (mm)	D <sub>1</sub> (mm)	D <sub>2</sub> (mm)	H <sub>1</sub> (mm)	H <sub>2</sub> (mm)	L (mm)	(g)	(pcs.)	
17	29.8	53	17	48	80	635	2	*1
19	32.3	53	19	48	80	655	2	*1
21	34.8	53	21	48	80	680	2	*1
22	36	53	22	48	80	686	2	*1
24	38.5	53	24	48	80	693	2	*1
27	42.3	53	27	48	80	745	2	*1
30	46	53	30	48	80	761	2	*1
32	48.5	53	32	53	85	770	2	*1
33	49.8	53	33	53	85	781	2	*1
35	52.3	53	35	53	85	800	2	*1
36	53.5	53	36	52	85	808	2	*1
38	56	53	38	52	85	865	2	*1
41	59.8	53	38	51	85	937	2	*1
46	66	53	38	50	85	1032	2	*1
50	71	53	55	-	85	1220	2	*1

\*1 C-Ring=1801C, Pin/O-Ring=1801A/B → P254-255

### 18300M / 18300A



6-point Sockets, deep  
6-kant Steckschlüssel, lang  
Douilles 6-pans, longues

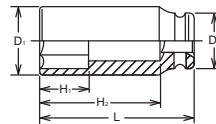

18300M (mm)	D <sub>1</sub> (mm)	D <sub>2</sub> (mm)	H <sub>1</sub> (mm)	H <sub>2</sub> (mm)	L (mm)	(g)	(pcs.)	
17	32.8	54	17	77	108	1000	2	*1
19	35.3	54	19	77	108	1010	2	*1
21	37.8	54	21	77	108	1010	2	*1
22	39	54	22	77	108	1010	2	*1
23	40.3	54	23	77	108	1063	2	*1
24	41.5	54	24	77	108	1060	2	*1
25	42.8	54	25	77	108	1085	2	*1
26	44	54	26	77	108	1133	2	*1
27	45.3	54	27	77	108	1125	2	*1
28	46.5	54	28	77	108	1140	2	*1
29	47.8	54	29	77	108	1120	2	*1
30	49	54	30	77	108	1179	2	*1
31	50.3	54	31	77	108	1125	2	*1
32	51.5	54	32	77	108	1200	2	*1
33	52.8	54	33	77	108	1200	2	*1
34	54	54	34	77	108	1280	2	*1
35	55.3	54	35	77	108	1300	2	*1
36	56.5	54	36	76	108	1280	2	*1
37	57.8	54	37	76	108	1320	2	*1
38	59	54	38	76	108	1423	2	*1
40	61.5	54	38	75	108	1415	2	*1
41	62.8	54	38	75	108	1450	2	*1
42	64	54	38	75	108	1550	2	*1
44	66.5	54	38	74	108	1636	2	*1
45	67.8	54	38	74	108	1660	2	*1
46	69	54	38	74	108	1680	2	*1
48	71.5	54	67	-	108	1500	2	*1
50	74	54	66	-	108	1650	2	*1
52	76.5	54	65	-	108	1770	2	*1
55	80.3	54	63	-	108	1855	2	*1
60	86.5	54	60	-	108	2047	2	*1
65	92.8	54	58	-	108	2310	2	*1
70	99	54	55	-	108	2440	1	*1
75	105.3	86	52	-	108	3646	1	*2
80	111.5	86	49	-	108	4039	1	*2
85	117.8	86	59	-	108	4000	1	*2
90	124	86	57	-	108	4200	1	*2
95	130.3	86	55	-	108	4400	1	*2

\*1 C-Ring=1801C, Pin/O-Ring=1801A/B  
\*2 C-Ring=1802C, Pin/O-Ring=1802A/B

→ P254-255

18300A (inch)	D <sub>1</sub> (mm)	D <sub>2</sub> (mm)	H <sub>1</sub> (mm)	H <sub>2</sub> (mm)	L (mm)	(g)	(pcs.)	
11/16	32.8	54	17	77	108	978	2	*1
3/4	35.3	54	19	77	108	1010	2	*1
7/8	39	54	22	77	108	1010	2	*1
15/16	41.5	54	24	77	108	1060	2	*1
1	42.8	54	25	77	108	1085	2	*1
1. 1/16	45.3	54	27	77	108	1125	2	*1
1. 1/8	47.8	54	29	77	108	1120	2	*1
1. 3/16	49	54	30	77	108	1179	2	*1
1. 1/4	51.5	54	32	77	108	1200	2	*1
1. 5/16	54	54	34	77	108	1280	2	*1
1. 3/8	55.3	54	35	77	108	1300	2	*1
1. 7/16	57.8	54	37	76	108	1320	2	*1
1. 1/2	59	54	38	76	108	1423	2	*1
1. 9/16	61.5	54	38	75	108	1415	2	*1
1. 5/8	62.8	54	38	75	108	1450	2	*1
1.11/16	65.3	54	38	74	108	1577	2	*1
1. 3/4	67.8	54	38	74	108	1660	2	*1
1.13/16	69	54	38	74	108	1680	2	*1
1. 7/8	71.5	54	67	-	108	1500	2	*1
1.15/16	72.8	54	67	-	108	1570	2	*1
2	75.3	54	66	-	108	1605	2	*1
2. 1/16	76.5	54	65	-	108	1770	2	*1
2. 1/8	79	54	64	-	108	1812	2	*1
2. 3/16	80.3	54	63	-	108	1855	2	*1
2. 1/4	82.8	54	62	-	108	1916	2	*1
2. 5/16	84	54	61	-	108	1987	2	*1
2. 3/8	86.5	54	60	-	108	2047	2	*1
2. 7/16	89	54	59	-	108	2041	2	*1
2. 1/2	91.5	54	58	-	108	2250	2	*1
2. 9/16	92.8	54	58	-	108	2310	2	*1
2. 5/8	95.3	54	56	-	108	2370	1	*1
2. 3/4	99	54	55	-	108	2440	1	*1
2. 7/8	102.8	86	53	-	108	3600	1	*2
2.15/16	105.3	86	52	-	108	3646	1	*2
3	106.5	86	51	-	108	3677	1	*2
3. 1/16	109	86	50	-	108	3939	1	*2
3. 1/8	111.5	86	49	-	108	4039	1	*2
3. 3/16	112.8	86	48	-	108	4170	1	*2

\*1 C-Ring=1801C, Pin/O-Ring=1801A/B  
\*2 C-Ring=1802C, Pin/O-Ring=1802A/B

→ P254-255

## 18301M / 18301A

6-point Deep Sockets, Thin Walled  
6-kant Steckschlüssel, dünnwandig  
Douilles à paroi mince longues, 6-pans

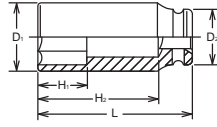

18301M (mm)	D <sub>1</sub> (mm)	D <sub>2</sub> (mm)	H <sub>1</sub> (mm)	H <sub>2</sub> (mm)	L (mm)	(g)	(pcs.)	⚡
17	29.8	53	17	77	108	692	2	*1
18	31	53	18	77	108	710	2	*1
19	32.3	53	19	77	108	725	2	*1
20	33.5	53	20	77	108	740	2	*1
21	34.8	53	21	77	108	750	2	*1
22	36	53	22	77	108	770	2	*1
23	37.3	53	23	77	108	780	2	*1
24	38.5	53	24	77	108	800	2	*1
26	41	53	26	77	108	830	2	*1
27	42.3	53	27	77	108	860	2	*1
29	44.8	53	29	77	108	880	2	*1
30	46	53	30	77	108	910	2	*1
32	48.5	53	32	77	108	970	2	*1
33	49.8	53	33	77	108	980	2	*1
34	51	53	34	77	108	980	2	*1
35	52.3	53	35	77	108	986	2	*1
36	53.5	53	36	76	108	992	2	*1
38	56	53	38	76	108	1025	2	*1
39	57.3	53	38	76	108	1130	2	*1
41	59.8	53	38	75	108	1213	2	*1
42	61	53	38	75	108	1245	2	*1
43	62.3	53	38	74	108	1400	2	*1
46	66	53	38	74	108	1400	2	*1
50	71	53	38	-	108	1520	2	*1
55	77.3	53	62	-	108	1735	2	*1
60	83.5	53	59	-	108	1985	2	*1
65	89.8	53	56	-	108	2090	2	*1
70	96	53	55	-	108	2310	1	*1

\*1 C-Ring=1801C, Pin/O-Ring=1801A/B → P254-255

18301A (inch)	D <sub>1</sub> (mm)	D <sub>2</sub> (mm)	H <sub>1</sub> (mm)	H <sub>2</sub> (mm)	L (mm)	(g)	(pcs.)	⚡
11/16	29.8	53	17	77	108	692	2	*1
3/4	32.3	53	19	77	108	725	2	*1
13/16	34.8	53	21	77	108	750	2	*1
7/8	36	53	22	77	108	770	2	*1
15/16	38.5	53	24	77	108	800	2	*1
1	39.8	53	25	77	108	828	2	*1
1. 1/16	42.3	53	27	77	108	860	2	*1
1. 1/8	44.8	53	29	77	108	909	2	*1
1. 3/16	46	53	30	77	108	910	2	*1
1. 1/4	48.5	53	32	77	108	970	2	*1
1. 5/16	51	53	34	77	108	1014	2	*1
1. 3/8	52.3	53	35	77	108	986	2	*1
1. 7/16	54.8	53	37	76	108	1000	2	*1
1. 1/2	56	53	38	76	108	1025	2	*1
1. 9/16	58.5	53	38	75	108	1200	2	*1
1. 5/8	59.8	53	38	75	108	1213	2	*1
1.11/16	62.3	53	38	74	108	1285	2	*1
1. 3/4	64.8	53	38	74	108	1360	2	*1
1.13/16	66	53	38	74	108	1400	2	*1

\*1 C-Ring=1801C, Pin/O-Ring=1801A/B → P254-255

## 18104M

Special Sockets for Spring Clamps  
Steckschlüssel für Federbriden  
Douilles pour brides de ressorts

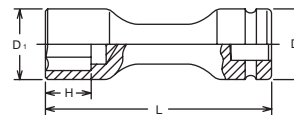

18104M (mm)	D <sub>1</sub> (mm)	D <sub>2</sub> (mm)	H (mm)	L (mm)	(g)	(pce.)	⚡
24	41.5	54	24	170	1327	1	*1
27	45.3	54	27	170	1375	1	*1
28	46.5	54	28	170	1390	1	*1
30	49	54	30	170	1407	1	*1
32	51.5	54	32	170	1537	1	*1
33	52.8	54	33	170	1590	1	*1
34	54	54	34	170	1670	1	*1
36	56.5	54	36	170	1800	1	*1

\*1 C-Ring=1801C, Pin/O-Ring=1801A/B → P254-255



SURFACE DRIVE

## 18310M

Surface Drive Sockets, deep  
Surface Drive Steckschlüssel, lang  
Douilles longues, Surface Drive



18310M (mm)	D <sub>1</sub> (mm)	D <sub>2</sub> (mm)	H <sub>1</sub> (mm)	H <sub>2</sub> (mm)	L (mm)	(g)	(pcs.)	⚡
24	41.5	54	24	77	108	1060	2	*1
27	45.3	54	27	77	108	1125	2	*1
30	49	54	30	77	108	1179	2	*1
32	51.5	54	32	77	108	1200	2	*1
33	52.8	54	33	77	108	1200	2	*1
36	56.5	54	36	76	108	1280	2	*1
41	62.8	54	38	75	108	1450	2	*1

\*1 C-Ring=1801C, Pin/O-Ring=1801A/B → P254-255

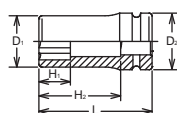

Z-SERIES  
HAND  
TITANIUM  
ACCESSORIES  
SCREWDRIVERS  
IMPACT  
SLEEVE-DRIVE  
PROTECTOR  
INDUSTRIAL  
AUTOMOTIVE  
MOTORCYCLE  
CONSTRUCTION  
SPARE PART

# Impact Sockets Impact Steckschlüssel Douilles Impact

# 1"

Z-SERIES  
HAND  
TITANIUM  
SCREWDRIVERS ACCESSORIES  
IMPACT  
SLEEVE-DRIVE  
PROTECTOR  
INDUSTRIAL  
AUTOMOTIVE  
MOTORCYCLE  
CONSTRUCTION  
SPARE PART

## 18106 Bit Holder Klingenhalter Porte embouts

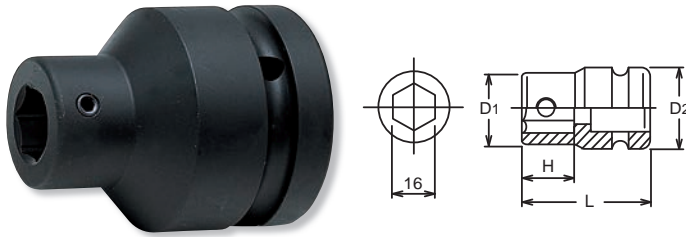

	D <sub>1</sub> (mm)	D <sub>2</sub> (mm)	H (mm)	L (mm)	(g)	(pcs.)	
<b>18106</b>	32	54	16	68	640	2	*1

\*1 C-Ring=1801C, Pin/O-Ring=1801A/B  P254-255

### 16106-SC

 Replacement Screw : M6x10,  3mm

## 107-16 Bits for Inhex Screws Klingen für Innsechskant-Schrauben Embouts pour vis 6-pans males creux

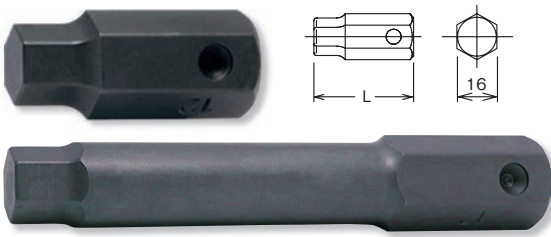

107-16 (mm)	L (mm)	L (mm)	L=40 (g)	L=100 (g)	(pcs.)
<b>10</b>	40	100	46	122	10
<b>12</b>	40	100	52	146	10
<b>13</b>	40	-	56	-	10
<b>14</b>	40	100	60	166	10
<b>16</b>	40	-	69	-	10
<b>17</b>	40	100	73	193	10
<b>18</b>	40	-	78	-	10
<b>19</b>	40	100	80	232	10
<b>22</b>	40	100	97	254	10

107-16 (inch)	L (mm)	(g)	(pcs.)
<b>3/8</b>	40	45	10
<b>1/2</b>	40	56	10
<b>9/16</b>	40	60	10
<b>5/8</b>	40	69	10
<b>3/4</b>	40	80	10

## 107-16 (T) TORX® Bits TORX® Klingen Embouts, TORX®

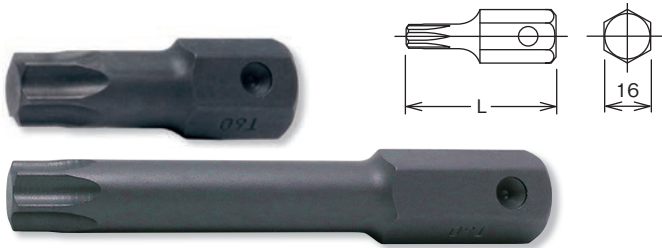

107-16 (T)	L (mm)	L (mm)	L=50 (g)	L=100 (g)	(pcs.)
<b>T55</b>	50	100	57	108	10
<b>T60</b>	50	100	64	130	10
<b>T70</b>	50	100	73	159	10

## 107-16 (IP) TORXPLUS® Bits TORXPLUS® Klingen Embouts TORXPLUS®



107-16 (IP)	L (mm)	(g)	(pcs.)
<b>55IP</b>	50	57	10
<b>60IP</b>	50	64	10
<b>70IP</b>	50	73	10

## 107-16 (XZN) Bits XZN Klingen XZN Embouts de vissage, XZN

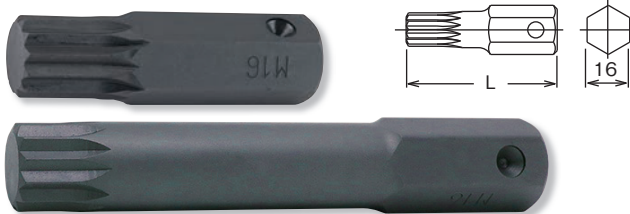

107-16 (XZN)	L (mm)	L (mm)	L=60 (g)	L=100 (g)	(pcs.)
<b>M14</b>	60	100	83	131	10
<b>M16</b>	60	100	93	161	10
<b>M18</b>	60	100	103	177	10

## 18106-16 Bit Holder complete with Bit, Inhex Klingenhalter komplett mit Klinge, Innsechskant Porte embouts avec bit 6-pans creux



18106-16 (mm)	D (mm)	H (mm)	L (mm)	(g)	(pcs.)	
<b>10</b>	54	24	92	686	2	*1
<b>12</b>	54	24	92	692	2	*1
<b>13</b>	54	24	92	696	2	*1
<b>14</b>	54	24	92	700	2	*1
<b>16</b>	54	24	92	709	2	*1
<b>17</b>	54	24	92	713	2	*1
<b>18</b>	54	24	92	718	2	*1
<b>19</b>	54	24	92	764	2	*1
<b>22</b>	54	24	92	781	2	*1

18106-16 (inch)	D (mm)	H (mm)	L (mm)	(g)	(pcs.)	
<b>1/2</b>	54	24	92	696	2	*1
<b>9/16</b>	54	24	92	700	2	*1
<b>5/8</b>	54	24	92	709	2	*1
<b>3/4</b>	54	24	92	764	2	*1

\*1 C-Ring=1801C, Pin/O-Ring=1801A/B  P254-255

18107-22 (mm)	D (mm)	H (mm)	L (mm)	(g)	(pcs.)	
19	54	28	98	910	2	*1
22	54	28	98	932	2	*1
24	54	28	98	946	2	*1
27	54	28	98	986	2	*1
30	54	28	98	1008	2	*1
32	54	28	103	1029	2	*1

\*1 C-Ring=1801C, Pin/O-Ring=1801A/B → P254-255



18107	D <sub>1</sub> (mm)	D <sub>2</sub> (mm)	H (mm)	L (mm)	(g)	(pcs.)	
18107	44	54	22	70	770	2	*1

\*1 C-Ring=1801C, Pin/O-Ring=1801A/B → P254-255

16107-SC

Replacement Screw : M8x14, 4mm



**18107-22** ● Bit Holder complete with Bit, Inhex  
Klingenhalter komplett mit Klinge, Innensechskant  
Porte embouts avec bit 6-pans creux

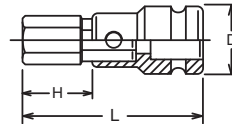

**18107** ○ Bit Holder  
Klingenhalter  
Porte embouts

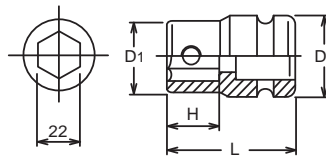

**107-22** ● Bits for Inhex Screws  
Klingen für Innensechskant-Schrauben  
Embouts pour vis 6-pans males creux

107-22 (mm)	L (mm)	(g)	(pcs.)
17	50	120	10
19	50	140	10
22	50	162	10
24	50	176	10
27	50	200	10
30	50	227	10
32	55	243	10

107-22 (inch)	L (mm)	(g)	(pcs.)
5/8	50	120	10
3/4	50	140	10
7/8	50	162	10
1	50	190	10
1. 1/4	55	243	10

107-22 (T)	L (mm)	(g)	(pcs.)
T 70	60	125	10
T 80	60	141	10
T 90	60	155	10
T100	60	170	10

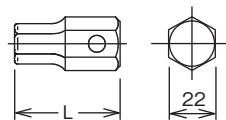

**107-22 (T)** ● TORX® Bits  
TORX® Klingen  
Embouts, TORX®

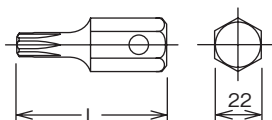

# Impact Sockets Impact Steckschlüssel Douilles Impact

# 1"

Z-SERIES  
HAND  
TITANIUM  
SCREWDRIVERS ACCESSORIES  
IMPACT  
SLEEVE-DRIVE  
PROTECTOR  
INDUSTRIAL  
AUTOMOTIVE  
MOTORCYCLE  
CONSTRUCTION  
SPARE PART

**18760** Extension Bars  
Verlängerungen  
Rallonges

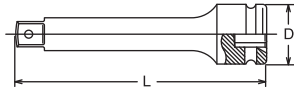

	D (mm)	L (mm)	(g)	(pce.)	(V)
<b>18760-175</b>	54	175	1400	1	*1
<b>18760-200</b>	54	200	1580	1	*1
<b>18760-250</b>	54	250	1885	1	*1
<b>18760-330</b>	54	330	2380	1	*1

\*1 C-Ring=1801C, Pin/O-Ring=1801A/B → P254-255

**18888AL** Adaptor (Quick Release)  
Verbindungsstück (Quick Release)  
Adaptateur (Quick Release)

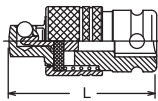

LOCKING  
ADAPTOR

	L (mm)	(g)	(pcs.)	(V)
<b>18888AL</b>	95	980	2	*1

\*1 C-Ring=1801C, Pin/O-Ring=1801A/B → P254-255

### Lock & Quick Release

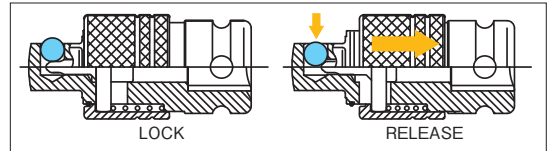

You may not hold the sliding part while moving to avoid heating up by friction and reduction by wear.

**18770** Universal Joint  
Gelenk-Einsatz  
Joint articulé

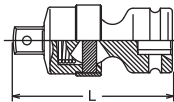

	L (mm)	(g)	(pce.)	(V)
<b>18770</b>	127	1350	1	*1
<b>18771</b>	115	1210	1	*1

\*1 C-Ring=1801C, Pin/O-Ring=1801A/B → P254-255

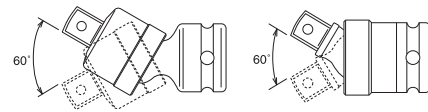

Our ball joints are spring-loaded and can therefore be adjusted to an angle of max. 30°.

Unsere Kugelgelenke sind federbelastet dadurch sind sie auf einen Winkel von max 30° einstellbar.

Nos joints à rotule sont à ressort et peuvent donc être réglés jusqu'à un angle de 30° maximum.

**18771** Universal Joint  
Gelenk-Einsatz  
Joint articulé

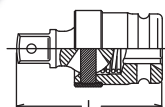



	(sq.)	(sq.)	L (mm)	(g)	(pce.)	
18866A	1"	3/4"	66.5	580	1	*1
18866A-200	1"	3/4"	200	1100	1	*1

\*1 C-Ring=1801C, Pin/O-Ring=1801A/B → P254-255

**⚠** Adapting down from bigger square drive to smaller square drive may lead to excessive torque load and possibly cause breakage. Always stay within safe torque of the smaller square drive.

Die mit **⚠** gekennzeichneten Artikel können bei Überbelastung zu Bruch gehen. Aus Gründen Ihrer eigenen Sicherheit sollten die betreffenden Werkzeuge nie ruckartig, sondern nach und nach belastet werden, um Bruch und damit verbundene mögliche Verletzungen zu vermeiden.

Il est possible d'appliquer aux articles marqués **⚠** des couples de serrage susceptibles d'occasionner leur rupture. Pour votre propre sécurité, veuillez toujours appliquer la charge d'une manière uniforme et progressive. Ceci pour éviter ruptures et accidents.

	(sq.)	(sq.)	L (mm)	(g)	(pce.)	
18877A	1"	1.1/2"	80	935	1	*1

\*1 C-Ring=1801C, Pin/O-Ring=1801A/B → P254-255

### 18866A Adaptors Verbindungsstücke Réducteurs

### 18866A-200 **⚠**

No Warranty **⚠**  
Keine Garantie  
Sans Garantie

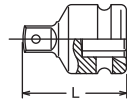

### 18877A Adaptor Verbindungsstück Augmentateur

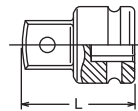

## 17400M / 17400A

6-point Sockets  
6-kant Steckschlüssel  
Douilles 6-pans

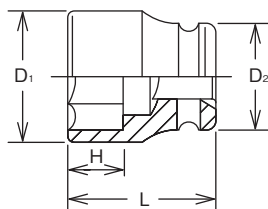

17400M (mm)	D <sub>1</sub> (mm)	D <sub>2</sub> (mm)	H (mm)	L (mm)	(g)	(pce.)	⚡
36	62	86	20	77	2126	1	*1
41	68	86	22	80	2346	1	*1
42	70	86	22	80	2330	1	*1
46	74	86	26	84	2360	1	*1
50	79	86	27	84	2400	1	*1
52	82	86	38	84	2340	1	*1
54	84	86	38	84	2340	1	*1
55	85	86	44	90	2450	1	*1
58	88	86	44	90	2510	1	*1
60	91	86	43	90	2640	1	*1
65	97	86	48	95	3050	1	*1
70	103	86	52	100	3350	1	*1
75	108	86	56	105	3700	1	*1
80	115	86	60	110	4240	1	*1
85	122	86	60	110	4550	1	*1
90	128	86	60	112	4840	1	*1
95	135	127	52	112	7660	1	*2
100	140	127	53	115	7700	1	*2
105	146	127	57	120	8000	1	*2
110	153	127	60	124	9200	1	*2
115	160	127	62	128	10700	1	*2
120	166	127	64	132	11200	1	*2
125	173	127	67	136	13000	1	*2
130	180	127	69	140	14200	1	*2
135	186	127	73	145	14940	1	*2
140	190	127	76	150	15600	1	*2
150	200	127	83	160	16500	1	*2

17400A (inch)	D <sub>1</sub> (mm)	D <sub>2</sub> (mm)	H (mm)	L (mm)	(g)	(pce.)	⚡
1. 5/8	68	86	22	80	2346	1	*1
1.11/16	71	86	22	80	2300	1	*1
1. 3/4	73	86	22	80	2290	1	*1
1.13/16	74	86	26	84	2360	1	*1
1. 7/8	77	86	26	84	2440	1	*1
1.15/16	79	86	27	84	2400	1	*1
2	80	86	27	84	2420	1	*1
2. 1/16	82	86	38	84	2340	1	*1
2. 1/8	84	86	38	84	2340	1	*1
2. 3/16	85	86	44	90	2450	1	*1
2. 1/4	87	86	43	90	2460	1	*1
2. 5/16	88	86	44	90	2510	1	*1
2. 3/8	91	86	43	90	2640	1	*1
2. 7/16	93	86	47	95	2860	1	*1
2. 1/2	96	86	47	95	3000	1	*1
2. 9/16	97	86	48	95	3050	1	*1
2. 5/8	100	86	51	100	3300	1	*1
2.11/16	101	86	51	100	3300	1	*1
2. 3/4	103	86	52	100	3350	1	*1
2.13/16	105	86	55	105	3670	1	*1
2. 7/8	106	86	55	105	3610	1	*1
2.15/16	108	86	56	105	3700	1	*1
3	108	86	55	105	3680	1	*1
3. 1/8	115	86	60	110	4240	1	*1
3. 1/4	118	86	59	110	4370	1	*1
3. 3/8	123	86	60	110	4570	1	*1
3. 1/2	128	86	60	112	4840	1	*1
3. 5/8	132	86	52	112	5500	1	*1
3. 3/4	135	127	52	112	7660	1	*2
3. 7/8	140	127	53	115	7700	1	*2
4	146	127	57	120	8000	1	*2
4. 1/8	146	127	57	120	8000	1	*2
4. 1/4	153	127	60	124	9200	1	*2
4. 1/2	160	127	62	128	10700	1	*2
4. 5/8	166	127	64	132	11200	1	*2
4. 3/4	168	127	64	132	11200	1	*2
4. 7/8	173	127	67	136	13000	1	*2
5	180	127	69	140	14200	1	*2
5. 1/4	186	127	73	145	14940	1	*2
6	205	127	88	165	16500	1	*2
6. 1/2	205	127	94	175	17500	1	*2

\*1 C-Ring=1700C, Pin/O-Ring=1701A/B  
\*2 Pin/O-Ring=1702A/B

# 1-1/2"

Impact Sockets  
Impact Steckschlüssel  
Douilles Impact

Z-SERIES  
HAND  
TITANIUM  
ACCESSORIES  
SCREWDRIVERS  
IMPACT  
SLEEVE-DRIVE  
PROTECTOR  
INDUSTRIAL  
AUTOMOTIVE  
MOTORCYCLE  
CONSTRUCTION  
SPARE PART

17405M (mm)	D <sub>1</sub> (mm)	D <sub>2</sub> (mm)	H (mm)	L (mm)	(g)	(pce.)	
46	74	86	26	84	2360	1	*1
50	79	86	27	84	2400	1	*1
55	85	86	44	90	2450	1	*1
60	91	86	43	90	2640	1	*1
65	97	86	48	95	3050	1	*1
70	103	86	52	100	3350	1	*1
75	108	86	56	105	3700	1	*1
80	115	86	60	110	4240	1	*1
85	122	86	60	110	4550	1	*1
90	128	86	60	112	4840	1	*1
95	135	127	52	112	7660	1	*2
100	140	127	53	115	7700	1	*2

17405A (inch)	D <sub>1</sub> (mm)	D <sub>2</sub> (mm)	H (mm)	L (mm)	(g)	(pce.)	
1.11/16	71	86	22	80	2300	1	*1
1. 3/4	73	86	22	80	2290	1	*1
1. 7/8	77	86	26	84	2440	1	*1
1.15/16	79	86	27	84	2400	1	*1
2	80	86	27	84	2420	1	*1
2. 1/16	82	86	38	84	2340	1	*1
2. 1/8	84	86	38	84	2340	1	*1
2. 3/16	85	86	44	90	2450	1	*1
2. 1/4	87	86	43	90	2460	1	*1
2. 3/8	91	86	43	90	2640	1	*1
2. 7/16	93	86	47	95	2860	1	*1
2. 1/2	96	86	47	95	3000	1	*1
2. 9/16	97	86	48	95	3050	1	*1
2. 5/8	100	86	51	100	3300	1	*1

\*1 C-Ring=1700C, Pin/O-Ring=1701A/B  
\*2 Pin/O-Ring=1702A/B

→ P254-255

## 17405M / 17405A

12-point Sockets  
12-kant Steckschlüssel  
Douilles 12-pans

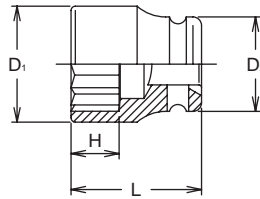

## 17300M / 17300A

6-point Deep Sockets  
6-kant-Steckschlüssel,lang  
Douilles longues 6-pans

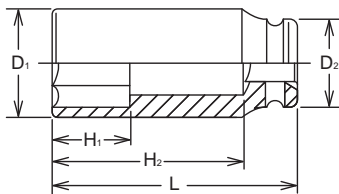

17300M (mm)	D <sub>1</sub> (mm)	D <sub>2</sub> (mm)	H <sub>1</sub> (mm)	H <sub>2</sub> (mm)	L (mm)	(g)	(pce.)	
36	63	86	26	70.5	115	2800	1	*1
41	68	86	27	70.5	115	3080	1	*1
42	70	86	27	70.5	115	3140	1	*1
46	74	86	28	80.5	125	3440	1	*1
50	79	86	30	90.5	135	3840	1	*1
54	84	86	30	90.5	135	4160	1	*1
55	85	86	33	90.5	135	4130	1	*1
60	91	86	35	90.5	135	4370	1	*1
65	97	86	38	99.5	145	5260	1	*1
70	103	86	40	98.5	145	5780	1	*1
75	108	86	42	107.5	155	6580	1	*1
80	115	86	46	115.5	165	7740	1	*1
85	122	86	49	114.5	165	7420	1	*1
90	128	86	52	122.5	175	9630	1	*1
95	135	127	55	121.5	175	10450	1	*2
100	140	127	58	130.5	185	9741	1	*2
105	146	127	62	138.5	195	10850	1	*2
110	153	127	65	137.5	195	11500	1	*2
115	160	127	68	135.5	195	12160	1	*2
120	166	127	72	144.5	205	13680	1	*2
125	173	127	74	142.5	205	14450	1	*2
130	180	127	76	142.5	205	15190	1	*2

\*1 C-Ring=1700C, Pin/O-Ring=1701A/B  
\*2 Pin/O-Ring=1702A/B

→ P254-255

17300A (inch)	D <sub>1</sub> (mm)	D <sub>2</sub> (mm)	H <sub>1</sub> (mm)	H <sub>2</sub> (mm)	L (mm)	(g)	(pce.)	
1. 5/8	68	86	27	70.5	115	3080	1	*1
1.11/16	71	86	27	70.5	115	3180	1	*1
1. 3/4	73	86	27	70.5	115	3210	1	*1
1.13/16	74	86	28	80.5	125	3440	1	*1
1. 7/8	77	86	28	80.5	125	3550	1	*1
1.15/16	79	86	28	80.5	125	3590	1	*1
2	80	86	30	90.5	135	3916	1	*1
2. 1/16	82	86	30	90.5	135	4030	1	*1
2. 1/8	84	86	30	90.5	135	4160	1	*1
2. 3/16	85	86	33	90.5	135	4200	1	*1
2. 1/4	87	86	33	90.5	135	4160	1	*1
2. 3/8	91	86	35	90.5	135	4370	1	*1
2. 7/16	93	86	35	90.5	135	4490	1	*1
2. 1/2	96	86	35	90.5	135	4630	1	*1
2. 9/16	97	86	38	99.5	145	5260	1	*1
2. 5/8	100	86	38	99.5	145	5320	1	*1
2.11/16	101	86	38	99.5	145	5670	1	*1
2. 3/4	103	86	40	98.5	145	5780	1	*1
2.13/16	105	86	40	98.5	145	6000	1	*1
2. 7/8	106	86	40	98.5	145	6080	1	*1
2.15/16	108	86	42	107.5	155	6580	1	*1
3	108	86	42	107.5	155	6850	1	*1
3. 1/8	115	86	46	115.5	165	7740	1	*1
3. 3/4	135	127	55	121.5	175	12200	1	*2
3. 7/8	140	127	56	120.5	175	11080	1	*2

\*1 C-Ring=1700C, Pin/O-Ring=1701A/B  
\*2 Pin/O-Ring=1702A/B

→ P254-255

Impact Sockets  
Impact Steckschlüssel  
Douilles Impact

# 1-1/2"

Z-SERIES  
HAND  
TITANIUM  
SCREWDRIVERS ACCESSORIES  
IMPACT  
SLEEVE-DRIVE  
PROTECTOR  
INDUSTRIAL  
AUTOMOTIVE  
MOTORCYCLE  
CONSTRUCTION  
SPARE PART

## 17108

Bit Holder  
Klingenhalter  
Porte-embouts

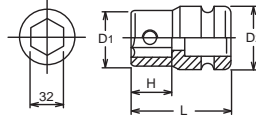

	D <sub>1</sub> (mm)	D <sub>2</sub> (mm)	H (mm)	L (mm)	(g)	(pce.)	
<b>17108</b>	60	86	30	85	2200	1	*1

\*1 C-Ring=1700C, Pin/O-Ring=1701A/B → P254-255

### 16107-SC

Replacement Screw : M8x14, ●4mm  
Ersatzschraube : M8x14, ●4mm  
Vis de remplacement : M8x14, ●4mm

## 107-32

Bit for Inhex Screws  
Klingen für Innensechskant-Schrauben  
Embouts pour vis 6-pans mâle creux

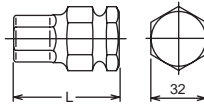

107-32 (mm)	L (mm)	(g)	(pcs.)
19	60	300	10
22	60	320	10
24	60	330	10
27	60	360	10
30	60	390	10
32	60	410	10
36	60	460	10

## 17108-32

Bit Holder complete with Bit  
Klingenhalter, komplett mit Klinge  
Porte embouts avec bit

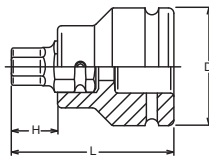

17108-32 (mm)	D (mm)	H (mm)	L (mm)	(g)	(pce.)	
19	86	30	115	2500	1	*1
22	86	30	115	2520	1	*1
24	86	30	115	2530	1	*1
27	86	30	115	2560	1	*1
30	86	30	115	2590	1	*1
32	86	30	115	2610	1	*1
36	86	30	115	2660	1	*1

\*1 C-Ring=1700C, Pin/O-Ring=1701A/B → P254-255



# 1-1/2"

Impact Sockets  
Impact Steckschlüssel  
Douilles Impact

	D (mm)	L (mm)	(g)	(pce.)	⚡
17760-175	86	175	3300	1	*1
17760-250	86	250	4500	1	*1
17760-330	86	330	5200	1	*1

\*1 C-Ring=1700C, Pin/O-Ring=1701A/B → P254-255

**17760** Extension Bars  
Verlängerungen  
Rallonges

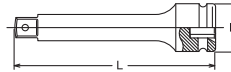

	L (mm)	(g)	(pce.)	⚡
17770	200	4700	1	*1

\*1 C-Ring=1700C, Pin/O-Ring=1701A/B → P254-255

**17770** Universal Joint  
Gelenk-Einsatz  
Joint articulé

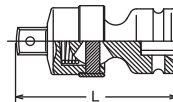

	(sq.)	(sq.)	L (mm)	(g)	(pce.)	⚡
17788A	1.1/2"	1"	98	2600	1	*1

\*1 C-Ring=1700C, Pin/O-Ring=1701A/B → P254-255

**⚠** Adapting down from bigger square drive to smaller square drive may lead to excessive torque load and possibly cause breakage. Always stay within safe torque of the smaller square drive.

Die mit **⚠** gekennzeichneten Artikel können bei Überbelastung zu Bruch gehen. Aus Gründen Ihrer eigenen Sicherheit sollten die betreffenden Werkzeuge nie ruckartig, sondern nach und nach belastet werden, um Bruch und damit verbundene mögliche Verletzungen zu vermeiden.

Il est possible d'appliquer aux articles marqués **⚠** des couples de serrage susceptibles d'occasionner leur rupture. Pour votre propre sécurité, veuillez toujours appliquer la charge d'une manière uniforme et progressive. Ceci pour éviter ruptures et accidents.

**17788A** **⚠** Adaptor  
Verbindungsstück  
Réducteur **No Warranty  
Keine Garantie  
Sans Garantie**

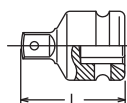

	(sq.)	(sq.)	L (mm)	(g)	(pce.)	⚡
17799A	1.1/2"	2.1/2"	115	3790	1	*1

\*1 C-Ring=1700C, Pin/O-Ring=1701A/B → P254-255

**17799A** Adaptor  
Verbindungsstück  
Augmentateur

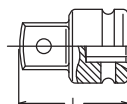

Z-SERIES  
HAND  
TITANIUM  
ACCESSORIES  
SCREWDRIVERS  
IMPACT  
SLEEVE-DRIVE  
PROTECTOR  
INDUSTRIAL  
AUTOMOTIVE  
MOTORCYCLE  
CONSTRUCTION  
SPARE PART

## 19400M / 19400A

6-point Sockets  
6-kant Steckschlüssel  
Douilles 6-pans

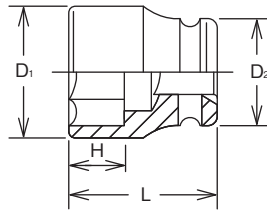

19400M (mm)	D <sub>1</sub> (mm)	D <sub>2</sub> (mm)	H (mm)	L (mm)	(g)	(pce.)	
50	88	127	39	115	7270	1	*1
55	94	127	42	115	7350	1	*1
60	100	127	45	125	7870	1	*1
65	105	127	48	125	7790	1	*1
70	110	127	51	125	7640	1	*1
75	118	127	54	125	7740	1	*1
80	124	127	57	125	7640	1	*1
85	127	127	61	132	7840	1	*1
90	135	127	64	132	8500	1	*1
95	140	127	71	140	10160	1	*1
100	146	127	71	142	11500	1	*1
105	155	127	74	146	11350	1	*1
110	160	127	76	155	12710	1	*1
115	167	127	78	158	13980	1	*1
120	175	175	79	160	15430	1	*2
125	180	175	82	165	16590	1	*2
130	185	175	85	169	17590	1	*2
135	190	175	89	175	19030	1	*2
140	200	175	93	180	21810	1	*2
145	205	175	95	183	24440	1	*2
150	210	175	97	192	25720	1	*2
160	225	175	102	200	30920	1	*2
165	230	175	105	204	32610	1	*2
170	235	175	106	207	34390	1	*2
175	240	175	109	211	36210	1	*2
180	250	175	110	214	40630	1	*2
185	255	175	113	218	42690	1	*2
190	265	175	113	220	47440	1	*2
200	275	175	116	225	51550	1	*2
210	285	175	123	235	57170	1	*2
215	290	175	126	240	60260	1	*2
225	305	175	133	250	70180	1	*2
235	315	175	140	260	77060	1	*2

19400A (inch)	D <sub>1</sub> (mm)	D <sub>2</sub> (mm)	H (mm)	L (mm)	(g)	(pce.)	
2. 1/8	92	127	41	115	6665	1	*1
2. 3/8	100	127	45	125	7870	1	*1
2. 7/16	102	127	46	125	7840	1	*1
2. 1/2	103	127	47	125	7810	1	*1
2. 9/16	105	127	48	125	7790	1	*1
2. 5/8	107	127	49	125	7790	1	*1
2.11/16	108	127	50	125	7790	1	*1
2. 3/4	110	127	51	125	7640	1	*1
2.13/16	113	127	52	125	7690	1	*1
2. 7/8	115	127	53	125	7730	1	*1
2.15/16	118	127	54	125	7740	1	*1
3	120	127	55	125	7740	1	*1
3. 1/8	124	127	57	125	7640	1	*1
3. 1/4	125	127	59	125	7740	1	*1
3. 3/8	127	127	61	132	7840	1	*1
3. 1/2	135	127	64	132	8500	1	*1
3. 5/8	138	127	64	132	9330	1	*1
3. 3/4	140	127	71	140	10160	1	*1
3. 7/8	143	127	70	140	10830	1	*1
4	146	127	71	142	11500	1	*1
4. 1/8	155	127	70	142	11250	1	*1
4. 1/4	160	127	76	155	12710	1	*1
4. 3/8	163	127	76	155	13100	1	*1
4. 1/2	167	127	78	158	13980	1	*1
4. 5/8	175	175	79	160	15430	1	*2
4. 7/8	180	175	82	165	16590	1	*2
5	183	175	81	165	17090	1	*2
5. 1/4	190	175	89	175	19030	1	*2
5. 3/8	198	175	94	180	20880	1	*2
5. 1/2	200	175	93	180	21810	1	*2
5. 5/8	203	175	94	182	22480	1	*2
5. 3/4	207	175	103	192	24440	1	*2
6	217	175	100	196	28510	1	*2
6. 1/8	218	175	99	196	29720	1	*2
6. 5/8	233	175	105	205	33500	1	*2
7	248	175	110	213	39160	1	*2

\*1 Pin/O-Ring=1901A/B  
\*2 Pin/O-Ring=1902A/B

→ P255

# 2-1/2"

Impact Sockets  
Impact Steckschlüssel  
Douilles Impact

Z-SERIES  
HAND  
TITANIUM  
ACCESSORIES  
SCREWDRIVERS  
IMPACT  
SLEEVE-DRIVE  
PROTECTOR  
INDUSTRIAL  
AUTOMOTIVE  
MOTORCYCLE  
CONSTRUCTION  
SPARE PART

19300M (mm)	D <sub>1</sub> (mm)	D <sub>2</sub> (mm)	H <sub>1</sub> (mm)	H <sub>2</sub> (mm)	L (mm)	(g)	(pce.)	⚡
75	118	127	42	129	190	11930	1	*1
80	124	127	46	129	190	12280	1	*1
85	127	127	49	134	195	12480	1	*1
90	135	127	52	144	205	14000	1	*1
95	140	127	55	149	210	14630	1	*1
100	146	127	58	154	215	15520	1	*1
105	155	127	62	146.5	220	18250	1	*1
110	160	127	65	150.5	225	18740	1	*1
115	167	127	68	153.5	230	20940	1	*1
120	175	175	72	157.5	235	23530	1	*2
125	180	175	74	158.5	238	26110	1	*2
130	185	175	76	163.5	243	25320	1	*2
135	190	175	80	165.5	248	26290	1	*2
140	200	175	82	164.5	248	28940	1	*2
145	205	175	84	163.5	248	29520	1	*2
150	210	175	88	168.5	255	30600	1	*2
155	215	175	92	167.5	255	31680	1	*2
160	225	175	95	170.5	260	35560	1	*2
165	230	175	98	169.5	260	36040	1	*2
170	235	175	100	172.5	265	37230	1	*2
175	240	175	102	176.5	270	39420	1	*2

\*1 Pin/O-Ring=1901A/B → P255  
\*2 Pin/O-Ring=1902A/B

	D (mm)	L (mm)	(g)	(pce.)	⚡
19760-250	127	250	17800	1	*1
19760-500	127	500	27800	1	*1

\*1 Pin/O-Ring=1901A/B → P255

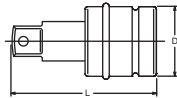

	L (mm)	(g)	(pce.)	⚡
19770	303	21360	1	*1

\*1 Pin/O-Ring=1901A/B → P255

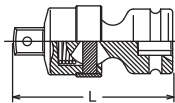

	(sq.)	(sq.)	L (mm)	(g)	(pce.)	⚡
19977A	2.1/2"	1.1/2"	145	7210	1	*1

\*1 Pin/O-Ring=1901A/B → P255

⚠ Adapting down from bigger square drive to smaller square drive may lead to excessive torque load and possibly cause breakage. Always stay within safe torque of the smaller square drive.

Die mit ⚠ gekennzeichneten Artikel können bei Überbelastung zu Bruch gehen. Aus Gründen Ihrer eigenen Sicherheit sollten die betreffenden Werkzeuge nie ruckartig, sondern nach und nach belastet werden, um Bruch und damit verbundene mögliche Verletzungen zu vermeiden.

Il est possible d'appliquer aux articles marqués ⚠ des couples de serrage susceptibles d'occasionner leur rupture. Pour votre propre sécurité, veuillez toujours appliquer la charge d'une manière uniforme et progressive. Ceci pour éviter ruptures et accidents.

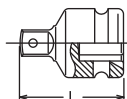

## 19300M 6-point Deep Sockets 6-kant-Steckschlüssel, lang Douilles longues 6-pans

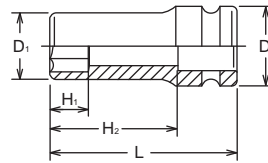

## 19760 Extension Bars Verlängerungen Rallonges



## 19770 Universal Joint Gelenk-Einsatz Joint articulé



## 19977A Adaptor Verbindungsstück Réducteur

No Warranty  
Keine Garantie  
Sans Garantie ⚠



# Impact Sockets Impact Steckschlüssel Douilles Impact

# 3-1/2"

## 10400M / 10400A

6-point Sockets  
6-kant Steckschlüssel  
Douilles 6-pans



FLAT DRIVE®

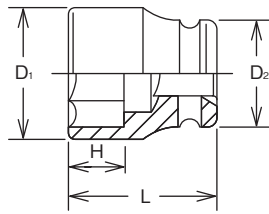

10400M (mm)	D <sub>1</sub> (mm)	D <sub>2</sub> (mm)	H (mm)	L (mm)	(g)	(pce.)	
105	165	175	86	176	19370	1	*1
110	170	175	88	179	20160	1	*1
115	175	175	90	183	21160	1	*1
120	180	175	91	185	21930	1	*1
125	188	175	94	190	23940	1	*1
130	193	175	97	194	25050	1	*1
135	200	175	101	199	26930	1	*1
140	205	175	105	205	28560	1	*1
145	210	200	106	207	29600	1	*2
150	215	200	109	212	31240	1	*2
160	228	200	114	220	35500	1	*2
165	235	200	117	224	37940	1	*2
170	240	200	118	227	39660	1	*2
175	245	200	121	231	41400	1	*2
180	255	200	122	234	45740	1	*2
185	265	200	125	238	50350	1	*2
190	275	200	125	239	54650	1	*2
200	285	200	128	245	59190	1	*2
210	295	200	135	255	64970	1	*2
215	300	200	138	260	68150	1	*2

10400A (inch)	D <sub>1</sub> (mm)	D <sub>2</sub> (mm)	H (mm)	L (mm)	(g)	(pce.)	
4.1/8	165	175	86	176	19370	1	*1
4.1/4	168	175	87	178	19770	1	*1
4.3/8	172	175	88	180	20660	1	*1
4.1/2	175	175	89	182	21160	1	*1
4.5/8	178	175	90	183	21550	1	*1
4.3/4	180	175	91	185	21930	1	*1
4.7/8	188	175	94	190	23940	1	*1
5	188	175	95	191	24500	1	*1
5.1/8	193	175	97	194	25050	1	*1
5.1/4	197	175	100	198	25990	1	*1
5.3/8	201	175	102	202	27750	1	*1
5.1/2	205	175	105	205	28560	1	*1
5.5/8	208	200	106	208	30110	1	*2
5.3/4	212	200	108	210	30610	1	*2
5.7/8	215	200	109	212	31240	1	*2
6	219	200	110	214	32460	1	*2
6.1/8	223	200	112	216	33670	1	*2
6.1/4	227	200	114	218	34590	1	*2
6.3/8	231	200	115	221	36720	1	*2
6.1/2	235	200	117	224	37940	1	*2
6.5/8	238	200	118	226	38800	1	*2
6.3/4	241	200	119	228	39870	1	*2
6.7/8	245	200	120	230	40640	1	*2
7	251	200	121	232	43570	1	*2
7.1/8	257	200	122	234	46450	1	*2
7.1/4	263	200	123	236	48400	1	*2
7.3/8	269	200	124	238	52500	1	*2
7.1/2	275	200	125	240	55350	1	*2
7.5/8	278	200	127	242	56050	1	*2
7.3/4	282	200	129	245	57620	1	*2
7.7/8	285	200	130	248	60870	1	*2
8	290	200	132	250	62550	1	*2
8.1/8	293	200	133	251	63760	1	*2
8.1/4	295	200	135	255	64970	1	*2
8.3/8	298	200	136	258	65580	1	*2
8.1/2	300	200	138	260	68150	1	*2
8.5/8	305	200	139	262	70760	1	*2
8.3/4	310	200	140	264	73830	1	*2
8.7/8	313	200	142	267	75780	1	*2

\*1 Pin/O-Ring=2001A/B

\*2 Pin/O-Ring=2002A/B

➔ P255

	(sq.)	(sq.)	L (mm)	(g)	(pce.)	
10099A	3.1/2"	2.1/2"	182	16870	1	*1

\*1 Pin/O-Ring=2001A/B

➔ P255

⚠ Adapting down from bigger square drive to smaller square drive may lead to excessive torque load and possibly cause breakage. Always stay within safe torque of the smaller square drive.

Die mit ⚠ gekennzeichneten Artikel können bei Überbelastung zu Bruch gehen. Aus Gründen Ihrer eigenen Sicherheit sollten die betreffenden Werkzeuge nie ruckartig, sondern nach und nach belastet werden, um Bruch und damit verbundene mögliche Verletzungen zu vermeiden.

Il est possible d'appliquer aux articles marqués ⚠ des couples de serrage susceptibles d'occasionner leur rupture. Pour votre propre sécurité, veuillez toujours appliquer la charge d'une manière uniforme et progressive. Ceci pour éviter ruptures et accidents.

## 10099A

Adaptor  
Verbindungsstück  
Réducteur

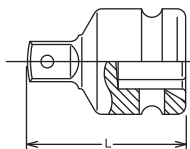



# SLEEVE-DRIVE SOCKETS

## SLEEVE-DRIVE STECKSCHLÜSSEL

### DOUILLES, SLEEVE DRIVE

3/8"

1/2"

3/4"



Sleeve-Drive Sockets  
 Sleeve-Drive Steckschlüssel  
 Douilles, Sleeve Drive

Z-SERIES  
 HAND  
 TITANIUM  
 ACCESSORIES  
 SCREWDRIVERS  
 IMPACT  
 SLEEVE-DRIVE  
 PROTECTOR  
 INDUSTRIAL  
 AUTOMOTIVE  
 MOTORCYCLE  
 CONSTRUCTION  
 SPARE PART



The deepened drive end of the **Sleeve-Drive** tools prevents the sometimes "wobbly" connection between pulse tool - extension - socket. An O-ring inside **Sleeve-Drive** optimizes the perfect fit of extension bars and sockets on the anvil to the effect, that the exactness of the required torque given by the pulse tool is generally improved. Further, the **Sleeve-Drive** avoids the direct transmission of vibrations on the pulse tool and finally on the operator.

Der **Sleeve-Drive** Vierkant-Antrieb vermeidet durch die vertiefte Passung den "Wackelkontakt" zwischen Maschine - Verlängerung - Steckschlüssel. Ein im **Antriebsende der Sleeve-Drive-Steckschlüssel** eingesetzter Ring optimiert den festen Sitz der Verlängerungen und Steckschlüssel auf der Schrauberspindel und sorgt somit für die unmittelbare Weitergabe des vorgegebenen Drehmomentes ohne wesentliche Drehkraftverluste. Nicht zuletzt vermeidet der **Sleeve-Drive** Antrieb die Übertragung von Schwingungen auf Mensch und Maschine.

Ces nouveaux outils **Sleeve-Drive** se caractérisent par un entraînement carré allongé et un joint torique incorporé. Le guidage rigide ainsi obtenu maintient les outils **Sleeve-Drive** dans l'axe de la broche de la machine et garantit une connection optimale machine-rallonges-douilles. Le jeu latéral et les vibrations engendrés par les outils traditionnels sont de ce fait supprimés. Il en résulte une transmission plus précise du coupe de serrage et un plus grand confort de travail pour l'opérateur.

Sleeve Drive Sockets

Wrenches

O-Ring

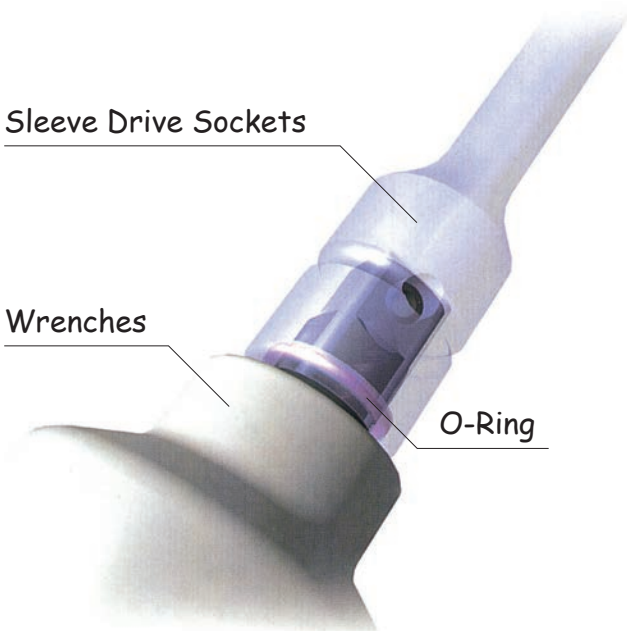

SLEEVE DRIVE SOCKET

PULSE TOOL

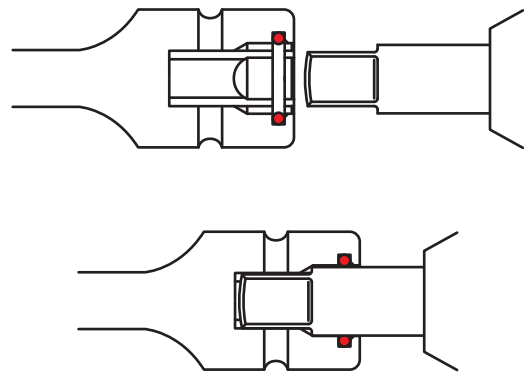

The "**Sleeve Drive**" Sockets and accessories are designed for use on Pulse Tools with anvils of certain lengths and diameters as shown hereunder.

Die serienmässigen "**Sleeve Drive**" Steckschlüssel können nur auf Impuls Schraubern mit Antriebswellen der nachstehenden Längen und Durchmesser gesteckt werden.

Les douilles "**Sleeve Drive**" ne peuvent être placées que sur des axes des boulonneuses à impulsions d'une longueur et d'un diamètre selon la spécification ci-dessous.

	Anvil Diameter (mm)	Minimum Anvil Length (mm)
3/8"sq.	12	10
1/2"sq.	16	10
3/4"sq.	25	11.8

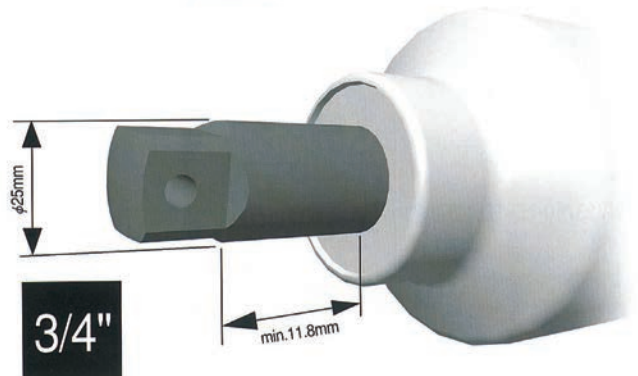
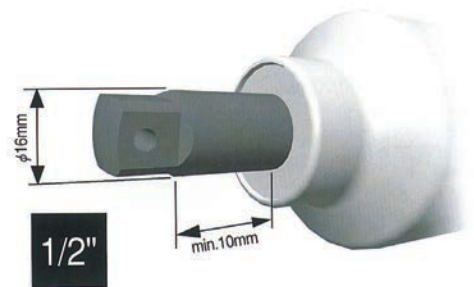
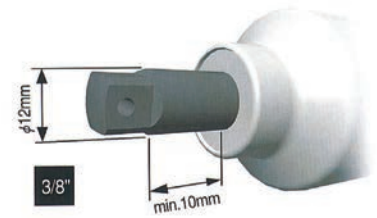

# 3/8"

Sleeve-Drive Sockets  
Sleeve-Drive Steckschlüssel  
Douilles, Sleeve Drive

NV13400 (mm)	D <sub>1</sub> (mm)	D <sub>2</sub> (mm)	H (mm)	L (mm)	(g)	(pcs.)	
8	13.3	19	6	43	53	10	*1
10	15.8	19	7	43	53	10	*1
11	17	19	8	43	54	10	*1
12	18.3	19	9	43	55	10	*1
13	19.5	22	10	43	80	10	*2
14	20.8	22	10	43	80	10	*2
15	22	22	11	43	81	10	*2
16	23.3	22	11	43	83	10	*2
17	24.5	22	11	43	85	10	*2
18	25.8	22	11	43	89	10	*2
19	27	22	11	43	98	10	*2
21	29.5	22	11	43	105	10	*2
22	30.8	22	11	43	112	10	*2

\*1 C-Ring=1301C, Pin/O-Ring=1301A/B

\*2 C-Ring=1302C, Pin/O-Ring=1302A/B

→ P254-255

## NV13400

6-point Sockets  
6-kant Steckschlüssel  
Douilles 6-pans

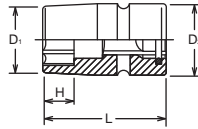

NV13145-100 (mm)	D <sub>1</sub> (mm)	D <sub>2</sub> (mm)	H (mm)	L (mm)	(g)	(pcs.)	
6	13	19	6	100	108	10	*1
8	13	19	8	100	110	10	*1
10	15.5	19	10	100	112	10	*1
12	18	19	12	100	120	10	*1
13	19	19	13	100	127	10	*1
14	21	19	14	100	131	10	*1
15	22	19	15	100	133	10	*1
16	24	19	15	100	144	10	*1
17	25	19	15	100	154	10	*1

NV13145-150 (mm)	D <sub>1</sub> (mm)	D <sub>2</sub> (mm)	H (mm)	L (mm)	(g)	(pcs.)	
6	13	19	6	150	160	10	*1
8	13	19	8	150	160	10	*1
10	15.5	19	10	150	165	10	*1
12	18	19	12	150	168	10	*1
13	19	19	13	150	170	10	*1
14	21	19	14	150	175	10	*1
15	22	19	15	150	177	10	*1
16	24	19	15	150	190	10	*1
17	25	19	15	150	203	10	*1

NV13145-200 (mm)	D <sub>1</sub> (mm)	D <sub>2</sub> (mm)	H (mm)	L (mm)	(g)	(pcs.)	
6	13	19	6	200	210	10	*1
8	13	19	8	200	210	10	*1
10	15.5	19	10	200	212	10	*1
12	18	19	12	200	214	10	*1
13	19	19	13	200	218	10	*1
14	21	19	14	200	220	10	*1
15	22	19	15	200	226	10	*1
16	24	19	15	200	235	10	*1
17	25	19	15	200	250	10	*1

\*1 C-Ring=1301C, Pin/O-Ring=1301A/B

→ P254-255

## NV13145-100 / -150 / -200

Extended Sockets  
Schaftsteckschlüssel  
Douilles rallongées

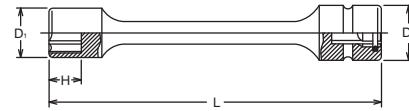

NV13760-75P	D (mm)	L (mm)	(g)	(pcs.)	
NV13760-75P	19	75	95	10	*1
NV13760-125P	19	125	125	10	*1
NV13760-150P	19	150	150	10	*1
NV13760-250P	19	250	255	10	*1

\*1 C-Ring=1301C, Pin/O-Ring=1301A/B

→ P254-255

## NV13760-P

Extension Bars  
Verlängerungen  
Rallonges



Z-SERIES  
HAND  
TITANIUM  
ACCESSORIES  
SCREWDRIVERS  
IMPACT  
SLEEVE-DRIVE  
PROTECTOR  
INDUSTRIAL  
AUTOMOTIVE  
MOTORCYCLE  
CONSTRUCTION  
SPARE PART

Z-SERIES  
HAND  
TITANIUM  
SCREWDRIVERS ACCESSORIES  
IMPACT  
SLEEVE-DRIVE  
PROTECTOR  
INDUSTRIAL  
AUTOMOTIVE  
MOTORCYCLE  
CONSTRUCTION  
SPARE PART

## 183H-35 / -75 / -150

Hex Bits  
Sechskant Bits  
Embouts, 6 pans creux

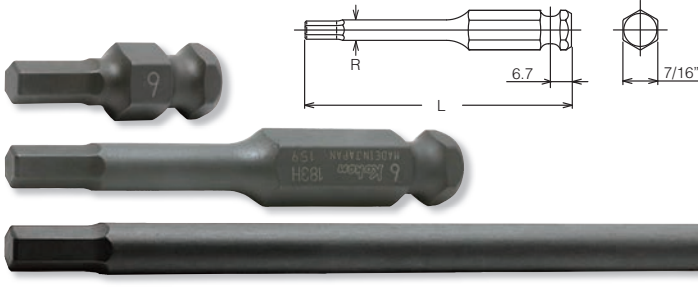

183H-35 (inch)	L (mm)	(g)	(pcs.)
3/16	35	15	10
7/32	35	16	10
1/4	35	18	10
5/16	35	20	10
3/8	35	26	10
7/16	35	28	10
1/2	35	38	10

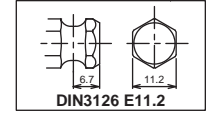

183H-35 (mm)	L (mm)	(g)	(pcs.)
3	35	15	10
4	35	15	10
5	35	15	10
6	35	18	10
7	35	19	10
8	35	20	10
New 9	35	23	10
10	35	26	10
11	35	28	10
12	35	30	10
14	35	35	10
16	35	47	10
17	35	50	10
18	35	53	10
19	35	56	10

183H-75 (mm)	L (mm)	R (mm)	(g)	(pcs.)
3	75	6	34	10
4	75	6	35	10
5	75	6.5	36	10
6	75	7.5	39	10
7	75	8.5	44	10
8	75	9.5	47	10
10	75	-	57	10
11	75	-	60	10
12	75	-	65	10
14	75	-	79	10

183H-150 (mm)	L (mm)	R (mm)	(g)	(pcs.)
4	150	6	51	10
5	150	6.5	55	10
6	150	7.5	65	10
8	150	9.5	87	10
10	150	-	118	10
12	150	-	136	10

## 183T-35 / -75 / -150 (T)

TORX® Bits  
TORX® Bits  
Embouts, TORX®

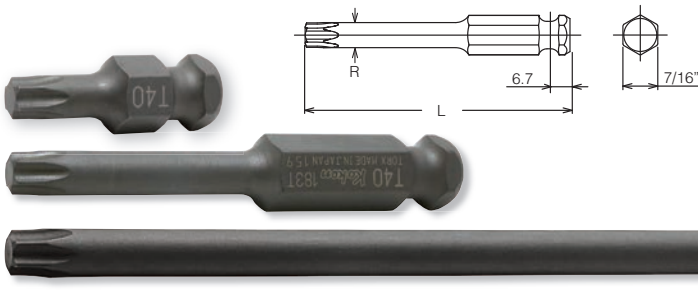

183T-35 (T)	L (mm)	(g)	(pcs.)
T25	35	18	10
T30	35	18	10
T40	35	20	10
T45	35	22	10
T50	35	26	10
T55	35	30	10
T60	35	38	10

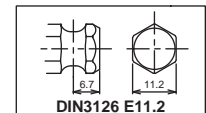

183T-150 (T)	L (mm)	R (mm)	(g)	(pcs.)
T30	150	6	50	10
T40	150	6.9	58	10
T45	150	8	70	10
T50	150	9	82	10
T55	150	11.4	113	10

183T-75 (T)	L (mm)	R (mm)	(g)	(pcs.)
T30	75	6	35	10
T40	75	6.9	37	10
T45	75	8	41	10
T50	75	9	45	10
T55	75	11.4	55	10
T60	75	13.5	67	10

## 183T-35 / -75 (IP)

TORXPLUS® Bits  
TORXPLUS® Bits  
Embouts TORXPLUS®

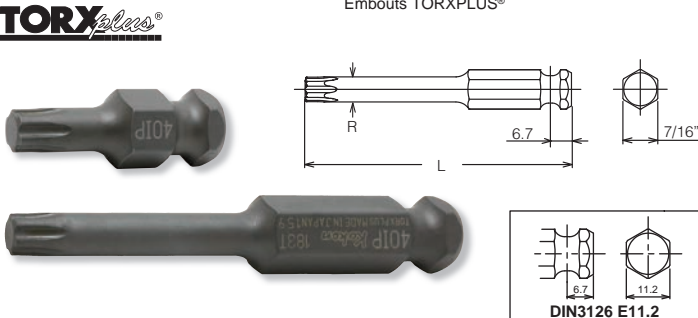

183T-35 (IP)	L (mm)	(g)	(pcs.)
30IP	35	18	10
40IP	35	20	10
45IP	35	22	10
50IP	35	26	10
55IP	35	30	10
60IP	35	38	10

183T-75 (IP)	L (mm)	R (mm)	(g)	(pcs.)
30IP	75	6	35	10
40IP	75	6.8	37	10
45IP	75	8	41	10
50IP	75	9	45	10
55IP	75	11.4	56	10
60IP	75	13.5	67	10

# 3/8", 1/2"

Sleeve-Drive Sockets  
Sleeve-Drive Steckschlüssel  
Douilles, Sleeve Drive

183X-35 (XZN)	L (mm)	(g)	(pcs.)
M 4	35	18	10
M 5	35	18	10
M 6	35	20	10
M 8	35	22	10
M10	35	26	10
M12	35	30	10
M14	35	38	10

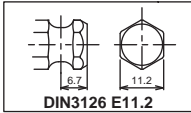

## 183X-35 / -75 / -150 (XZN)

XZN Bits  
XZN Bits  
Embouts, XZN

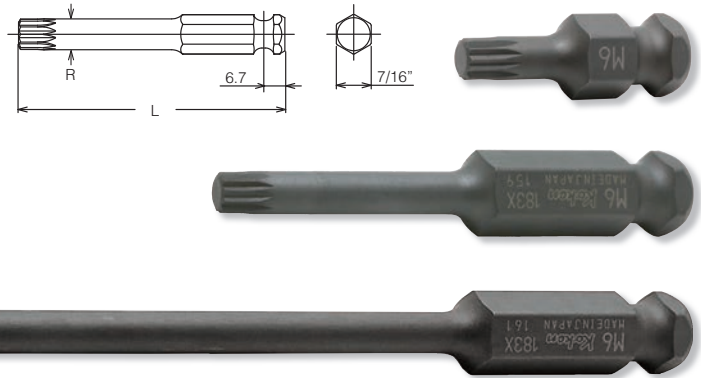

183X-75 (XZN)	L (mm)	R (mm)	(g)	(pcs.)
M 4	75	6	34	10
M 5	75	6	34	10
M 6	75	6.2	36	10
M 8	75	7.4	39	10
M10	75	9.8	54	10
M12	75	11.7	57	10
M14	75	13.5	67	10

183X-150 (XZN)	L (mm)	R (mm)	(g)	(pcs.)
M 5	150	6	50	10
M 6	150	6.2	53	10
M 8	150	7.4	64	10
M10	150	9.8	93	10
M12	150	11.7	121	10

	D <sub>1</sub> (mm)	D <sub>2</sub> (mm)	H (mm)	L (mm)	(g)	(pcs.)	
NV13134	22.5	22	15	45	100	5	*1

\*1 C-Ring=1301C, Pin/O-Ring=1301A/B → P254-255

For DIN3126 E11.2 Bits  
Für DIN3126 E11.2 Bits  
Pour DIN3126 E11.2 Embouts

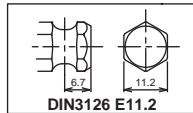

13134-SC

Replacement Screw : M8x5, ● 4mm



## NV13134

Bit Holder  
Klingenhalter  
Porte-embouts

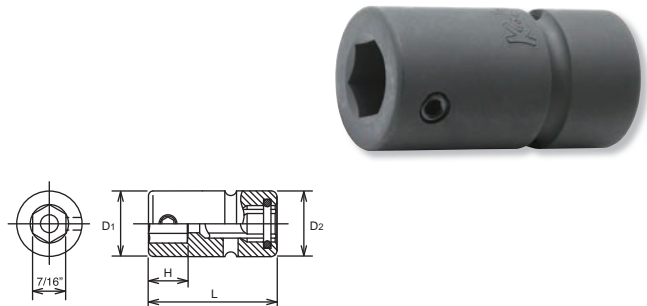

	D <sub>1</sub> (mm)	D <sub>2</sub> (mm)	H (mm)	L (mm)	(g)	(pcs.)	
NV14134	22.5	25	15	55	130	5	*1

\*1 C-Ring=1401C, Pin/O-Ring=1401A/B → P254-255

For DIN3126 E11.2 Bits  
Für DIN3126 E11.2 Bits  
Pour DIN3126 E11.2 Embouts

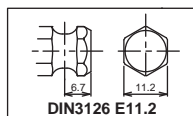

13134-SC

Replacement Screw : M8x5, ● 4mm



## NV14134

Bit Holder  
Klingenhalter  
Porte-embouts

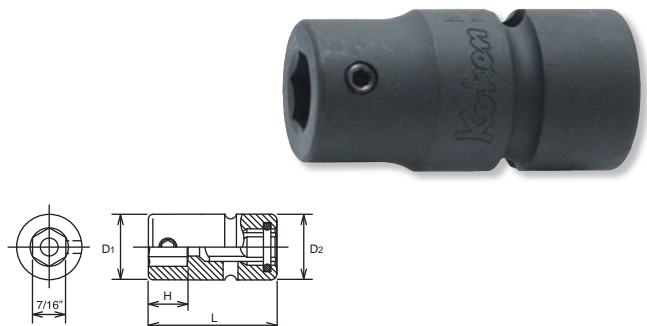

Z-SERIES  
HAND  
TITANIUM  
ACCESSORIES  
SCREWDRIVERS  
IMPACT  
SLEEVE-DRIVE  
PROTECTOR  
INDUSTRIAL  
AUTOMOTIVE  
MOTORCYCLE  
CONSTRUCTION  
SPARE PART

# Sleeve-Drive Sockets

## Sleeve-Drive Steckschlüssel

### Douilles, Sleeve Drive

# 1/2"

Z-SERIES  
HAND  
TITANIUM  
SCREWDRIVERS ACCESSORIES  
IMPACT  
SLEEVE-DRIVE  
PROTECTOR  
INDUSTRIAL  
AUTOMOTIVE  
MOTORCYCLE  
CONSTRUCTION  
SPARE PART

### NV14400

6-point Sockets  
6-kant Steckschlüssel  
Douilles 6-pans

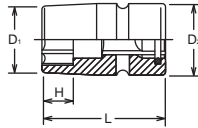

NV14400 (mm)	D <sub>1</sub> (mm)	D <sub>2</sub> (mm)	H (mm)	L (mm)	(g)	(pcs.)	
12	19.5	25	9	54	120	10	*1
13	20.7	25	10	54	120	10	*1
14	22	25	10	54	120	10	*1
15	23.2	30	11	54	188	10	*2
16	24.5	30	11	54	189	10	*2
17	25.7	30	12	54	190	10	*2
18	27	30	12	54	190	10	*2
19	28.2	30	12	54	190	10	*2
21	30.7	30	12	54	191	10	*2
22	32	30	12	54	192	10	*2
23	33.2	30	12	54	196	10	*2
24	34.5	30	12	54	200	10	*2

\*1 C-Ring=1401C, Pin/O-Ring=1401A/B → P254-255  
\*2 C-Ring=1402C, Pin/O-Ring=1402A/B

### NV14145-100 / -150 / -200

Extended Sockets  
Schaftsteckschlüssel  
Douilles rallongées

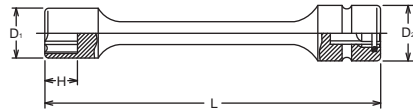

NV14145-100 (mm)	D <sub>1</sub> (mm)	D <sub>2</sub> (mm)	H (mm)	L (mm)	(g)	(pcs.)	
10	15.5	25	10	100	161	1	*1
12	18	25	12	100	178	1	*1
13	19	25	13	100	175	1	*1
14	21	25	14	100	181	1	*1
15	22	25	15	100	185	1	*1
16	24	25	15	100	193	1	*1
17	25	25	15	100	201	1	*1
18	26	25	15	100	211	1	*1
19	28	25	15	100	221	1	*1

NV14145-150 (mm)	D <sub>1</sub> (mm)	D <sub>2</sub> (mm)	H (mm)	L (mm)	(g)	(pcs.)	
10	15.5	25	10	150	200	1	*1
12	18	25	12	150	215	1	*1
13	19	25	13	150	220	1	*1
14	21	25	14	150	225	1	*1
15	22	25	15	150	230	1	*1
16	24	25	15	150	240	1	*1
17	25	25	15	150	250	1	*1
18	26	25	15	150	262	1	*1
19	28	25	15	150	275	1	*1

NV14145-200 (mm)	D <sub>1</sub> (mm)	D <sub>2</sub> (mm)	H (mm)	L (mm)	(g)	(pcs.)	
10	15.5	25	10	200	236	1	*1
12	18	25	12	200	250	1	*1
13	19	25	13	200	260	1	*1
14	21	25	14	200	270	1	*1
15	22	25	15	200	275	1	*1
16	24	25	15	200	287	1	*1
17	25	25	15	200	300	1	*1
18	26	25	15	200	310	1	*1
19	28	25	15	200	320	1	*1

\*1 C-Ring=1401C, Pin/O-Ring=1401A/B → P254-255

### NV14760-P

Extension Bars  
Verlängerungen  
Rallonges

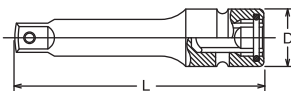

	D (mm)	L (mm)	(g)	(pcs.)	
NV14760-75P	25	75	149	10	*1
NV14760-125P	25	125	230	10	*1
NV14760-175P	25	175	308	10	*1
NV14760-250P	25	250	422	10	*1

\*1 C-Ring=1401C, Pin/O-Ring=1401A/B → P254-255

### NV14433A-P

Adaptors  
Verbindungsstücke  
Réducteurs

No Warranty  
Keine Garantie  
Sans Garantie



	(mm)	(mm)	L (mm)	(g)	(pcs.)	
NV14433A-75P	1/2"	3/8"	75	120	1	*1
NV14433A-100P	1/2"	3/8"	100	145	1	*1
NV14433A-150P	1/2"	3/8"	150	187	1	*1

\*1 C-Ring=1401C, Pin/O-Ring=1401A/B → P254-255

⚠ Adapting down from bigger square drive to smaller square drive may lead to excessive torque load and possibly cause breakage. Always stay within safe torque of the smaller square drive.

Die mit ⚠ gekennzeichneten Artikel können bei Überbelastung zu Bruch gehen. Aus Gründen Ihrer eigenen Sicherheit sollten die betreffenden Werkzeuge nie ruckartig, sondern nach und nach belastet werden, um Bruch und damit verbundene mögliche Verletzungen zu vermeiden.

Il est possible d'appliquer aux articles marqués ⚠ des couples de serrage susceptibles d'occasionner leur rupture. Pour votre propre sécurité, veuillez toujours appliquer la charge d'une manière uniforme et progressive. Ceci pour éviter ruptures et accidents.

# 3/4"

Sleeve-Drive Sockets  
Sleeve-Drive Steckschlüssel  
Douilles, Sleeve Drive

NV16400 (mm)	D <sub>1</sub> (mm)	D <sub>2</sub> (mm)	H (mm)	L (mm)	(g)	(pcs.)	⚡
17	30	44	12	65	448	5	*1
18	31.3	44	13	65	470	5	*1
19	32.5	44	13	65	455	5	*1
21	35	44	15	65	472	5	*1
22	36.3	44	16	65	471	5	*1
23	37.5	44	16	65	471	5	*1
24	38.8	44	16	65	467	5	*1
26	41.3	44	16	65	477	5	*1
27	42.5	44	16	65	473	5	*1
28	43.8	44	16	68	483	5	*1
29	45	44	18	68	464	5	*1
30	46.3	44	18	68	492	5	*1
32	48.8	44	19	70	514	5	*1
33	50	44	20	70	564	5	*1
34	51.3	44	20	70	588	5	*1
35	52.5	44	20	70	593	5	*1
36	53.8	44	20	70	598	5	*1
38	56.3	44	20	72	670	2	*1
41	60	44	22	72	687	2	*1
46	66.3	44	23	77	906	2	*1
50	69	44	23	77	1116	2	*1

\*1 C-Ring=1600C, Pin/O-Ring=1601A/B → P254-255

**NV16400**  6-point Sockets  
6-kant Steckschlüssel  
Douilles 6-pans

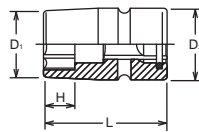

**NV16760** Extension Bars  
Verlängerungen  
Rallonges



	D (mm)	L (mm)	(g)	(pcs.)	⚡
NV16760-175	44	175	870	1	*1
NV16760-250	44	250	1160	1	*1
NV16760-330	44	330	1460	1	*1

\*1 C-Ring=1600C, Pin/O-Ring=1601A/B → P254-255

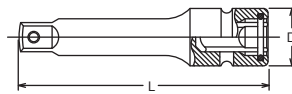

Z-SERIES  
HAND  
TITANIUM  
ACCESSORIES  
SCREWDRIVERS  
IMPACT  
SLEEVE-DRIVE  
PROTECTOR  
INDUSTRIAL  
AUTOMOTIVE  
MOTORCYCLE  
CONSTRUCTION  
SPARE PART

C-Ring Lock Clamps and Pullers  
 Sicherungsklemmen und Abzieher  
 Crochets de sécurité et extracteurs

Z-SERIES  
 HAND  
 TITANIUM  
 SCREWDRIVERS ACCESSORIES  
 IMPACT  
 SLEEVE-DRIVE  
 PROTECTOR  
 INDUSTRIAL  
 AUTOMOTIVE  
 MOTORCYCLE  
 CONSTRUCTION  
 SPARE PART



One Piece solid springs steel ring. Simply set by finger pushing and easily removed by puller. Much more convenient and safer than combination of pin and o-ring.

Aus starkem Federstahl, in einem Stück. Bequem, mit einem Fingerdruck einzusetzen und mit dem Auszieher zu lösen. Einfacher und sicherer als die Kombination Stift und Ring.

Acier à ressorts, en une pièce. Mise en place d'une simple pression du pouce, enlèvement au moyen de la griffe d'extraction. Beaucoup plus facile et sûr que la combinaison goupille/bague.

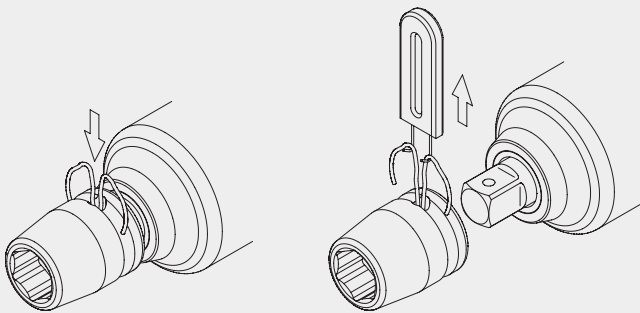

**C-Ring**

No.	□	Opening (mm)	📦 (pcs.)
1301C	3/8"	≤ 12	100
1302C	3/8"	> 12	100
1401C	1/2"	≤ 14	100
1402C	1/2"	> 14	100
1600C	3/4"	≤ 46	100
1801C	1"	≤ 70	100
1802C	1"	> 70	50
1700C	1-1/2"	≤ 90	50

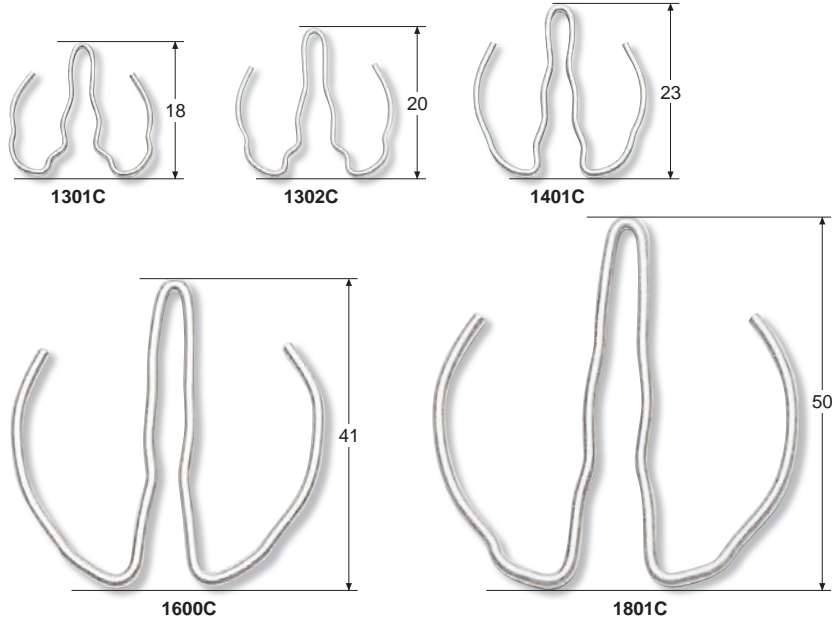

**C-Ring Set**

Set No.	□	C-Ring 10pcs.	Puller 1pce.
PK1301C	3/8"	1301C + 149	
PK1302C	3/8"	1302C + 149	
PK1401C	1/2"	1401C + 149	
PK1402C	1/2"	1402C + 149	
PK1600C	3/4"	1600C + 152	
PK1801C	1"	1801C + 152	

**Puller**

No.	□	□	📦 (pcs.)
149	3/8"	1/2"	10
152	3/4"	1"	10



149



152



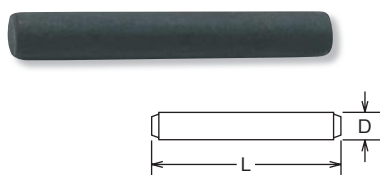

### Pin

No.	□	Opening (mm)	D (mm)	L (mm)	pcs.
1200A	1/4"		1.5	10.2	100
1301A	3/8"	≤ 12	2.5	14.5	100
1302A	3/8"	> 12	2.5	17.5	100
1401A	1/2"	≤ 14	3.5	20	100
1402A	1/2"	> 14	3.5	25	100
1500A	5/8"		4	29	100
1601A	3/4"	≤ 46	5.5	35	100
1602A	3/4"	> 46	5.5	45	100
1801A	1"	≤ 70	6	45	100
1802A	1"	> 70	6	75	50
1701A	1-1/2"	≤ 90	7	75	50
1702A	1-1/2"	> 90	7	110	50
1901A	2-1/2"	≤ 115	9	110	50
1902A	2-1/2"	> 115	9	155	50
2001A	3-1/2"	≤ 140	13	155	1
2002A	3-1/2"	> 140	13	180	1

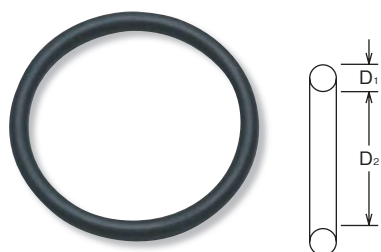

### O-Ring

No.	□	Opening (mm)	D <sub>1</sub> (mm)	D <sub>2</sub> (mm)	pcs.
1200B	1/4"		2.5	9	100
1301B	3/8"	≤ 12	3.5	13	100
1302B	3/8"	> 12	3.5	16	100
1401B	1/2"	≤ 14	4	19	100
1402B	1/2"	> 14	4	24	100
1500B	5/8"		5	28	100
1601B	3/4"	≤ 46	5	36	100
1602B	3/4"	> 46	5	45	100
1801B	1"	≤ 70	7	45	100
1802B	1"	> 70	7	75	50
1701B	1-1/2"	≤ 90	10	75	50
1702B	1-1/2"	> 90	10	114	50
1901B	2-1/2"	≤ 115	10.5	114	50
1902B	2-1/2"	> 115	10.5	158	50
2001B	3-1/2"	≤ 140	15	158	1
2002B	3-1/2"	> 140	15	183	1



Pins & O Rings/C-Ring Lock Clamps  
 Halteringe und Stifte/Sicherungsklemmen  
 Goupilles et joncs/Crochets de sécurité

Z-SERIES  
HAND  
TITANIUM  
SOREWDRIVERS ACCESSORIES  
IMPACT  
SLEEVE-DRIVE  
PROTECTOR  
INDUSTRIAL  
AUTOMOTIVE  
CONSTRUCTION MOTORCYCLE  
SPARE PART

IMPACT Standard Sockets	Sq. Dr.	1/4"											3/8"		1/2"		3/4"		1"		1-1/2"	
		C-Ring	1301C		1302C		1401C		1402C		1600C		1801C		1802C		1700C		1702A/B			
		O-Ring/Pin	1200A/B	1301A/B	1302A/B	1401A/B	1402A/B	1601A/B	1602A/B	1801A/B	1802A/B	1701A/B	1702A/B									
4		●																				
4.5	3/16	●																				
5		●																				
5.5		●																				
6	1/4	●	●			●																
7	9/32	●	●			●																
8	5/16	●	●			●																
9	11/32	●	●			●																
10	3/8	●	●			●																
11	7/16	●	●			●																
12		●	●			●																
13	1/2	●			●	●																
14	9/16	●			●	●			●													
15					●	●			●													
16	5/8				●	●			●													
17	11/16				●	●			●			●										
18					●	●			●			●										
19	3/4				●	●			●			●										
20					●	●			●			●										
21	13/16				●	●			●			●										
22	7/8				●	●			●			●										
23					●	●			●			●										
24	15/16				●	●			●			●										
25	1				●	●			●			●										
26					●	●			●			●										
27	1- 1/16				●	●			●			●										
28					●	●			●			●										
29	1- 1/8				●	●			●			●										
30	1- 3/16				●	●			●			●										
31					●	●			●			●										
32	1- 1/4				●	●			●			●										
33	1- 5/16				●	●			●			●										
34	1- 3/8				●	●			●			●										
36					●	●			●			●										
37	1- 7/16				●	●			●			●										
38	1- 1/2				●	●			●			●										
39					●	●			●			●										
40	1- 9/16				●	●			●			●										
41	1- 5/8				●	●			●			●										
42					●	●			●			●										
43	1- 11/16				●	●			●			●										
44					●	●			●			●										
45	1- 3/4				●	●			●			●										
46	1- 13/16				●	●			●			●										
47					●	●			●			●		●								
48	1- 7/8				●	●			●			●										
50	1- 15/16				●	●			●			●										
52	2				●	●			●			●										
54	2- 1/16				●	●			●			●										
55	2- 1/8				●	●			●			●										
56	2- 3/16				●	●			●			●										
58	2- 1/4				●	●			●			●										
60	2- 5/16				●	●			●			●										
62	2- 3/8				●	●			●			●										
63	2- 7/16				●	●			●			●										
65	2- 1/2				●	●			●			●										
67	2- 9/16				●	●			●			●										
68	2- 5/8				●	●			●			●										
70	2- 11/16				●	●			●			●										
75	2- 3/4				●	●			●			●										
80	2- 13/16				●	●			●			●										
85	2- 7/8				●	●			●			●										
90	2- 15/16				●	●			●			●										
95	3				●	●			●			●										
100	3- 1/16				●	●			●			●										
105	3- 1/8				●	●			●			●										
110	3- 1/2				●	●			●			●										
115	3- 5/8				●	●			●			●										
120	3- 3/4				●	●			●			●										
125	3- 7/8				●	●			●			●										
130	4				●	●			●			●										
135	4- 1/8				●	●			●			●										
140	4- 1/4				●	●			●			●										
145	4- 1/2				●	●			●			●										
150	4- 5/8				●	●			●			●										
155	4- 3/4				●	●			●			●										
160	4- 7/8				●	●			●			●										
165	5				●	●			●			●										
170	5- 1/4				●	●			●			●										
175	6				●	●			●			●										
180	6- 1/2				●	●			●			●										

**SOCKETS WITH TURNABLE PLASTIC PROTECTORS**  
**STECKSCHLÜSSEL MIT DREHBAREN SCHUTZHÜLSEN AUS KUNSTSTOFF**  
**DOUILLES A PROTECTIONS PLASTIFIEES**



Z-SERIES  
 HAND  
 TITANIUM  
 ACCESSORIES  
 SOREWDRIERS  
 IMPACT  
 SLEEVE-DRIVE  
 PROTECTOR  
 INDUSTRIAL  
 AUTOMOTIVE  
 MOTORCYCLE  
 CONSTRUCTION  
 SPARE PART



**Safety**

Turnable plastic protector increases operator's safety during assembly process.

Unsere drehbaren Kunststoff-Hülsen erhöhen die Arbeitssicherheit während des Montageprozesses.

Nos protections rotatives plastifiées augmentent la sécurité lors du montage.

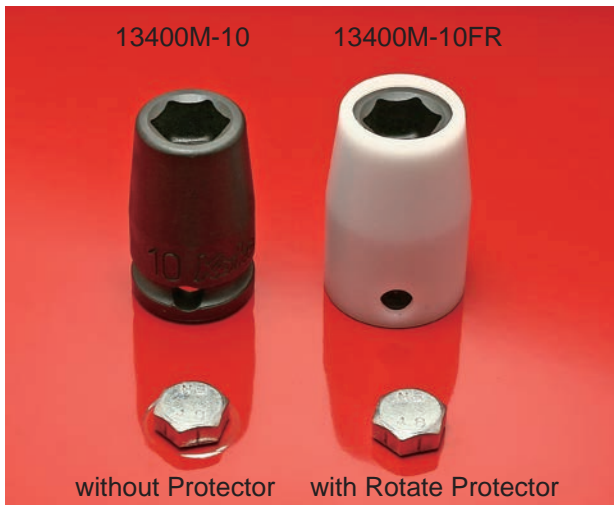

**Scratch proof**

Protector helps to reduce the possibility giving damage on painted, polished and sensitive surfaces. Protector is free rotation designed.

Die Protektoren vermeiden Beschädigungen an lackierten-, polierten- bzw. empfindlichen Oberflächen. Unsere Protektoren sind frei drehbar.

Les protections évitent des endommagements sur des surfaces laquées, polies ou sensibles. Nos protections ont une libre rotation.

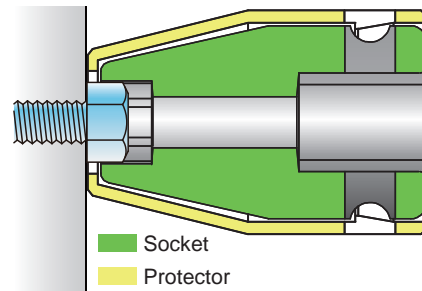

13400M (mm)	D <sub>1</sub> (mm)	D <sub>2</sub> (mm)	H (mm)	L (mm)	(g)
8FR	15.7	22	6	33.3	40
10FR	18.2	22	7	33.3	40
12FR	20.8	22	9	33.3	43
13FR	21.8	25	10	33.3	56
14FR	23.6	25	10	33.3	56
16FR	26.1	25	11	33.3	57
17FR	27.3	25	12	33.3	60



## 13400M-FR

6-point Sockets  
6-kant Steckschlüssel  
Douilles 6-pans

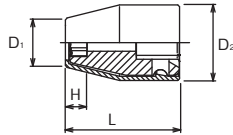

13300M (mm)	D <sub>1</sub> (mm)	D <sub>2</sub> (mm)	H <sub>1</sub> (mm)	H <sub>2</sub> (mm)	L (mm)	(g)
New 8FR	16.1	22	9	67.5	81.3	87
New 10FR	18.6	22	11	67.5	81.3	99
New 12FR	21.1	22	13	67.5	81.3	116
New 13FR	22.3	25	14	67.5	81.3	143
New 14FR	23.6	25	15	67.5	81.3	153
New 16FR	26	25	17	66.5	81.3	161
New 17FR	27.2	25	18	66.5	81.3	173

## 13300M-FR

6-point Sockets, deep  
6-kant Steckschlüssel, lang  
Douilles longues, 6-pans

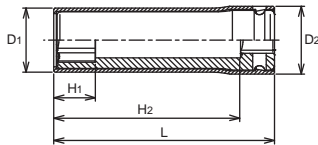

13300G (mm)	D <sub>1</sub> (mm)	D <sub>2</sub> (mm)	H <sub>1</sub> (mm)	H <sub>2</sub> (mm)	L (mm)	(g)
New 8FR	16.1	22	5	27.5	81.3	87
New 10FR	18.6	22	5.5	27	81.3	110
New 12FR	21.1	22	7	27	81.3	141
New 13FR	22.3	25	7.5	26	81.3	170
New 14FR	23.6	25	8	25	81.3	191
New 16FR	26	25	8.5	28	81.3	215
New 17FR	27.2	25	9	28	81.3	225

## 13300G-FR

Impact Socket with Sliding Magnet  
Impact Steckschlüssel mit versenkbarem Magnet  
Douilles Impact avec aimant, glissant pour écrous

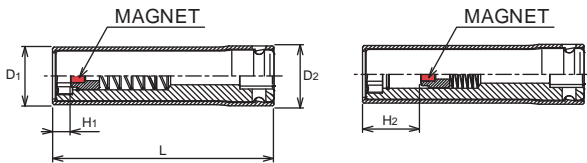

	D (mm)	L (mm)	(g)
13760-75P.FR	26.2	75	100
13760-125P.FR	26.2	125	145
13760-250P.FR	26.2	250	220

## 13760-P.FR

Extension Bars  
Verlängerungen  
Rallonges

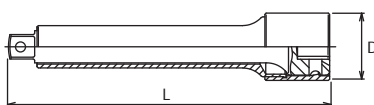

The protector could be broken with any impacts. Please handle with care.

Z-SERIES  
 HAND  
 TITANIUM  
 ACCESSORIES  
 SCREWDRIVERS  
 IMPACT  
 SLEEVE-DRIVE  
 PROTECTOR  
 INDUSTRIAL  
 AUTOMOTIVE  
 MOTORCYCLE  
 CONSTRUCTION  
 SPARE PART

## 14400M-FR

6-point Sockets  
 6-kant Steckschlüssel  
 Douilles 6-pans



14400M (mm)	D <sub>1</sub> (mm)	D <sub>2</sub> (mm)	H (mm)	L (mm)	(g)
10FR	19.5	28	7	39.3	90
12FR	22	28	9	39.3	90
13FR	23.2	28	10	39.3	90
14FR	24.8	28	11	39.3	90
16FR	27	33	10	39.3	135
17FR	28.2	33	12	39.3	135
19FR	31	33	13	39.3	130

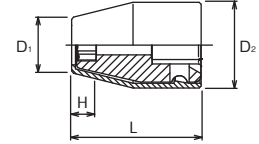

## 14300M-FR

6-point Sockets, deep  
 6-kant Steckschlüssel, lang  
 Douilles longues, 6-pans

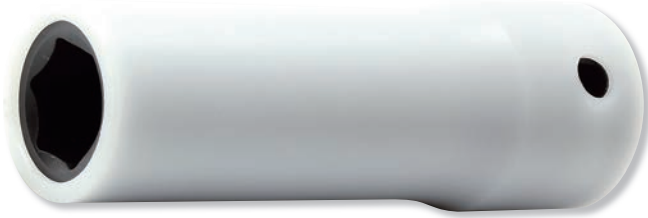

14300M (mm)	D <sub>1</sub> (mm)	D <sub>2</sub> (mm)	H <sub>1</sub> (mm)	H <sub>2</sub> (mm)	L (mm)	(g)
New 10FR	19.8	28	11	63	81.3	145
New 12FR	22.3	28	13	63	81.3	167
New 13FR	23.5	28	14	63	81.3	167
New 14FR	24.8	28	15	63	81.3	179
New 16FR	27.3	33	17	63	81.3	237
New 17FR	28.5	33	18	63	81.3	237
New 19FR	31	33	20	62	81.3	245

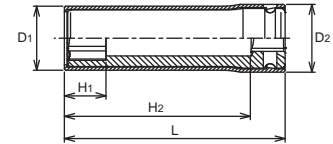

## 14300G-FR

Impact Socket with Sliding Magnet  
 Impact Steckschlüssel mit versenkbarem Magnet  
 Douilles Impact avec aimant, glissant pour écrous

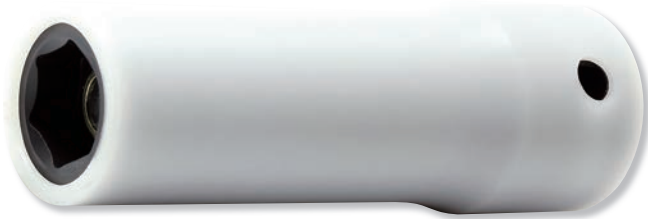

14300G (mm)	D <sub>1</sub> (mm)	D <sub>2</sub> (mm)	H <sub>1</sub> (mm)	H <sub>2</sub> (mm)	L (mm)	(g)
New 10FR	19.8	28	5.5	27	81.3	145
New 12FR	22.3	28	7	27	81.3	170
New 13FR	23.5	28	7.5	26	81.3	190
New 14FR	24.8	28	8	25	81.3	194
New 16FR	27.3	33	8.5	27.5	81.3	275
New 17FR	28.5	33	9	27.5	81.3	277
New 19FR	31	33	10	28.5	81.3	313

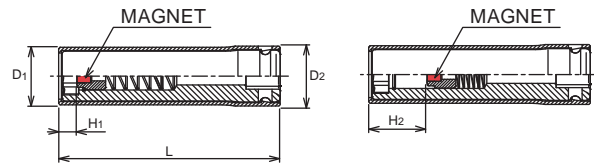

## 14760-P.FR

Extension Bars  
 Verlängerungen  
 Rallonges



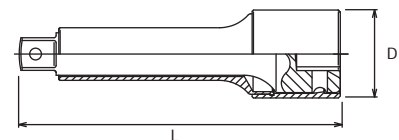

	D (mm)	L (mm)	(g)
14760-75P.FR	34.2	75	195
14760-125P.FR	34.2	125	280
14760-250P.FR	34.2	250	480





The protector could be broken with any impacts. Please handle with care.

### 113-75SV / -100SV / -150SV

 Nut Setters  
 Steckschlüssel Klingen  
 Embouts pour écrous 



113-75 (mm)	D (mm)	H (mm)	L (mm)	 (g)
<b>8SV</b>	15.1	6	75	34
<b>10SV</b>	16.9	7	75	37
<b>12SV</b>	19.4	8	75	44
<b>13SV</b>	20.4	8	75	45

113-100 (mm)	D (mm)	H (mm)	L (mm)	 (g)
<b>8SV</b>	15.1	6	100	43
<b>10SV</b>	16.9	7	100	47
<b>12SV</b>	19.4	8	100	54
<b>13SV</b>	20.4	8	100	55

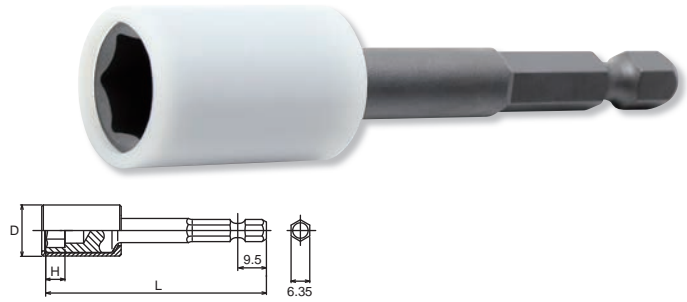
113-150 (mm)	D (mm)	H (mm)	L (mm)	 (g)
<b>8SV</b>	15.1	6	150	62
<b>10SV</b>	16.9	7	150	66
<b>12SV</b>	19.4	8	150	72
<b>13SV</b>	20.4	8	150	80



### 115-75SV / -100SV / -150SV

 Nut Setters with Magnet  
 Steckschlüssel Klingen mit Magnet  
 Embouts avec aimant pour écrous  



115-75 (mm)	D (mm)	H (mm)	L (mm)	 (g)
<b>8SV</b>	15.1	3.5	75	35
<b>10SV</b>	16.9	4.2	75	40
<b>12SV</b>	19.4	5.6	75	48
<b>13SV</b>	20.4	6	75	54

115-100 (mm)	D (mm)	H (mm)	L (mm)	 (g)
<b>8SV</b>	15.1	3.5	100	44
<b>10SV</b>	16.9	4.2	100	52
<b>12SV</b>	19.4	5.6	100	60
<b>13SV</b>	20.4	6	100	67

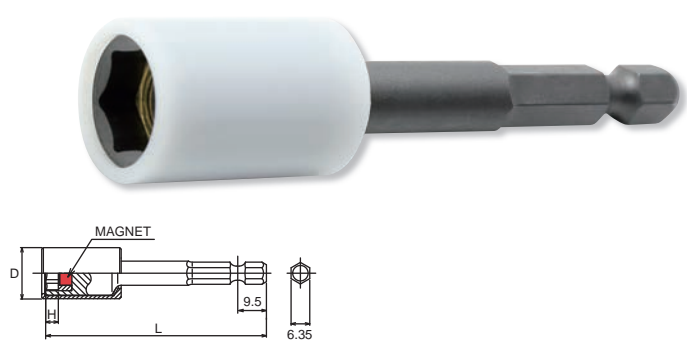
115-150 (mm)	D (mm)	H (mm)	L (mm)	 (g)
<b>8SV</b>	15.1	3.5	150	63
<b>10SV</b>	16.9	4.2	150	70
<b>12SV</b>	19.4	5.6	150	79
<b>13SV</b>	20.4	6	150	87



### 115G-100FR / -150FR / -200FR

 Nut Setters with sliding Magnet  
 Steckschlüssel Klingen mit versenkbarem Magnet  
 Embouts avec aimant, glissant pour écrous  

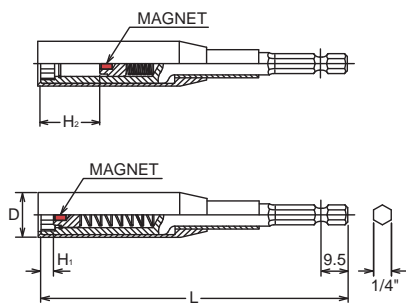

115G-100 (mm)	D (mm)	H <sub>1</sub> (mm)	H <sub>2</sub> (mm)	L (mm)	 (g)
<b>8FR</b>	15.1	4	26	100	55
<b>10FR</b>	16.9	4.5	26	100	60
<b>12FR</b>	19.3	6	26	100	80
<b>13FR</b>	20.4	6.5	25	100	85

115G-150 (mm)	D (mm)	H <sub>1</sub> (mm)	H <sub>2</sub> (mm)	L (mm)	 (g)
<b>8FR</b>	15.1	4	26	150	75
<b>10FR</b>	16.9	4.5	26	150	80
<b>12FR</b>	19.3	6	26	150	100
<b>13FR</b>	20.4	6.5	25	150	110

115G-200 (mm)	D (mm)	H <sub>1</sub> (mm)	H <sub>2</sub> (mm)	L (mm)	 (g)
<b>8FR</b>	15.1	4	26	200	90
<b>10FR</b>	16.9	4.5	26	200	100
<b>12FR</b>	19.3	6	26	200	125
<b>13FR</b>	20.4	6.5	25	200	135



 The protector could be broken with any impacts. Please handle with care.



Specifications or design of any product in this catalogue are subject to change without notice.

Wir behalten uns das Recht vor, jedes in diesem Katalog gezeigte Werkzeug, auch ohne vorherige Ankündigung, in Ausführung und Design ändern zu dürfen.

Nous nous réservons le droit de modifier les modèles et les dimensions des outils présentés dans ce catalogue et ce sans autre notification préalable.



**REPLACEMENT**

Remove a damaged Protector and put a new Protector on socket / Extension bar by pressing. For your safety, worn out or cracked Protector must be replaced.

**AUSTAUSCH**

Entfernen Sie defekte Protektoren und ersetzen Sie diese auf Ihrem Steckschlüssel/Verlängerung mittels einer Presse. Bitte tauschen Sie zu Ihrer Sicherheit verschlissene Protektoren aus !

**REPLACEMENT**

Retirez les protections défectueuses, remplacez celles-ci et fixez-les sur les douilles/rallonges à l'aide d'une presse. Pour votre sécurité remplacez toute protection défectueuse.



# INDUSTRIAL SOCKETS

STECKSCHLÜSSEL, INDUSTRIE-AUSFÜHRUNG  
CLÉS À DOUILLES, FINISSAGE INDUSTRIEL

1/4"

3/8"

1/2"



Z-SERIES  
HAND  
TITANIUM  
ACCESSORIES  
SCREWDRIVERS  
IMPACT  
SLEEVE-DRIVE  
PROTECTOR  
INDUSTRIAL  
AUTOMOTIVE  
CONSTRUCTION  
MOTORCYCLE  
SPARE PART

◆ INDUSTRIAL SOCKETS



Industrial sockets are thin walled sockets to be used on electric or pneumatic nut runners for assembly work only.

Bei den Industrial Steckschlüsseln handelt es sich um dünnwandige Werkzeuge, die ausschliesslich auf pneumatischen und elektrischen Drehschraubern (nicht schlagend) verwendet werden dürfen.

Les douilles Industrielles à paroi mince ne doivent être utilisées que sur des vis à fixer par visseuses (non-chocs).

**22400M** 6-point Sockets  
6-kant Steckschlüssel  
Douilles 6-pans

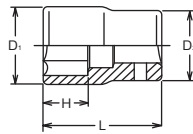

22400M (mm)	D <sub>1</sub> (mm)	D <sub>2</sub> (mm)	H (mm)	L (mm)	(g)	(pcs.)
6	9.2	11.2	5.5	22	9	10
7	10.3	11.2	6	22	9	10
8	11.2	11.7	6.9	22	11	10
10	14.3	12.9	7.7	22	15	10
12	16.8	15.5	9.3	22	23	10
13	18	16.4	9.8	22	23	10

**22425** TORX® Sockets  
TORX® Steckschlüssel  
Douilles TORX®

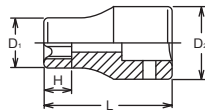

22425 (E)	D <sub>1</sub> (mm)	D <sub>2</sub> (mm)	H (mm)	L (mm)	(g)	(pcs.)
E 4	5.4	11.2	4.6	22	7	10
E 5	6.7	11.2	5.2	22	8	10
E 6	7.7	11.2	5.4	22	8	10
E 7	8.3	11.2	6.6	22	9	10
E 8	9.6	11.2	7	22	9	10
E10	11.3	12	8.2	22	10	10

TORX® (E)

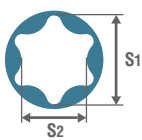

E	E4	E5	E6	E7	E8	E10	E11	E12	E14	E16	E18	E20	E22	E24	E26	E28	E30	E32
S <sub>1</sub> (ref. mm)	3.7	4.6	5.6	6.1	7.4	9.3	9.9	11.0	12.8	14.6	16.5	18.3	20.1	22.0	23.7	25.5	27.3	29.0
S <sub>2</sub> (ref. mm)	2.7	3.3	4.0	4.3	5.3	6.8	7.1	7.9	9.2	10.5	11.9	13.2	14.8	15.7	17.5	18.3	20.0	21.3

**22300M / 22300A** 6-point Sockets, deep  
6-kant Steckschlüssel, lang  
Douilles longues, 6-pans

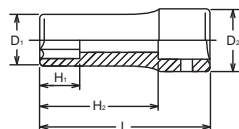

22300M (mm)	D <sub>1</sub> (mm)	D <sub>2</sub> (mm)	H <sub>1</sub> (mm)	H <sub>2</sub> (mm)	L (mm)	(g)	(pcs.)
7	10.3	11.2	8	40	50	24	10
8	11.2	11.7	9	40	50	28	10
10	14.3	12.9	11	39	50	33	10
12	16.8	15.5	13	39	50	50	10
13	18	16.4	14	39	50	50	10

22300A (inch)	D <sub>1</sub> (mm)	D <sub>2</sub> (mm)	H <sub>1</sub> (mm)	H <sub>2</sub> (mm)	L (mm)	(g)	(pcs.)
1/4	9.6	11.2	7	40	50	24	10
5/16	11.2	11.7	9	40	50	28	10
3/8	13.7	12.5	11	40	50	33	10

# 3/8" Steckschlüssel, Industrie-Ausführung

## Clés à douilles, finissage industriel

Z-SERIES  
HAND  
TITANIUM  
ACCESSORIES  
SCREWDRIVERS  
IMPACT  
SLEEVE-DRIVE  
PROTECTOR  
INDUSTRIAL  
AUTOMOTIVE  
MOTORCYCLE  
CONSTRUCTION  
SPARE PART

23400M (mm)	D <sub>1</sub> (mm)	D <sub>2</sub> (mm)	H (mm)	L (mm)	(g)	(pcs.)
6	9.9	17.3	6	26	20	10
7	10.8	17.3	6.5	26	20	10
8	12	17.3	6.9	26	22	10
10	14.5	17.3	8	26	24	10
11	15.8	17.3	9.3	26	25	10
12	16.8	17.3	9	26	25	10
13	18	17	9.4	26	24	10
14	19.5	18.5	11	27	31	10
15	21	19.5	11.5	28	39	10
16	22	20	12	28	42	10
17	23.5	21.5	12.5	29	51	10
18	24.6	22.5	13	30	51	10
19	26	23.5	13.5	30	53	10
21	28	26	14.5	32	77	10

23400A (inch)	D <sub>1</sub> (mm)	D <sub>2</sub> (mm)	H (mm)	L (mm)	(g)	(pcs.)
5/16	12	17.3	6.9	26	22	10
3/8	13.9	17.3	8	26	22	10
7/16	15.8	17.3	9.3	26	25	10
1/2	18	17	9.4	26	24	10
9/16	19.5	18.5	11	27	31	10
11/16	24.6	22.5	13	30	51	10
3/4	26	23.5	13.5	30	63	10

23405M (mm)	D <sub>1</sub> (mm)	D <sub>2</sub> (mm)	H (mm)	L (mm)	(g)	(pcs.)
8	12	17.3	6.9	26	22	10
10	14.5	17.3	8	26	24	10
12	16.8	17.3	9	26	25	10
14	19.5	18.5	11	27	31	10

23410M (mm)	D <sub>1</sub> (mm)	D <sub>2</sub> (mm)	H (mm)	L (mm)	(g)	(pcs.)
8	12	17.3	6.9	26	22	10
10	14.5	17.3	8	26	24	10
12	16.8	17.3	9	26	25	10
13	18	17	9.4	26	24	10
14	19.5	18.5	11	27	31	10
15	21	19.5	11.5	28	39	10
16	22	20	12	28	42	10
17	23.5	21.5	12.5	29	51	10
18	24.6	22.5	13	30	51	10
19	26	23.5	13.5	30	53	10

23425 (E)	D <sub>1</sub> (mm)	D <sub>2</sub> (mm)	H (mm)	L (mm)	(g)	(pcs.)
E 5	7	17.3	5.2	26	20	10
E 6	8.3	17.3	5.4	26	21	10
E 7	8.9	17.3	6.6	26	22	10
E 8	9.9	17.3	7	26	23	10
E10	12	17.3	8.2	26	24	10
E11	13.3	17.3	8.7	26	25	10
E12	14.5	17.3	9.3	26	26	10
E14	15.8	17.3	10.6	26	27	10
E16	18	17	11.8	26	27	10



### 23400M / 23400A

6-point Sockets  
6-kant Steckschlüssel  
Douilles 6-pans

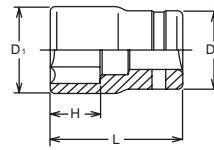

### 23405M

12-point Sockets  
12-kant Steckschlüssel  
Douilles 12-pans

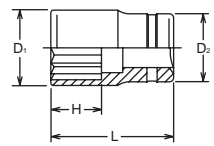

### 23410M

Surface Drive Sockets  
Surface Drive Steckschlüssel  
Douilles, Surface Drive

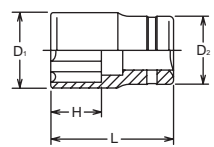

### 23425

TORX® Sockets  
TORX® Steckschlüssel  
Douilles TORX®

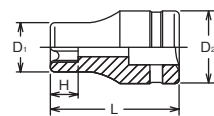

TORX® (E)

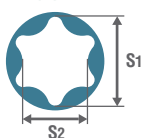

E	E4	E5	E6	E7	E8	E10	E11	E12	E14	E16	E18	E20	E22	E24	E26	E28	E30	E32
S <sub>1</sub> (ref. mm)	3.7	4.6	5.6	6.1	7.4	9.3	9.9	11.0	12.8	14.6	16.5	18.3	20.1	22.0	23.7	25.5	27.3	29.0
S <sub>2</sub> (ref. mm)	2.7	3.3	4.0	4.3	5.3	6.8	7.1	7.9	9.2	10.5	11.9	13.2	14.8	15.7	17.5	18.3	20.0	21.3

Industrial Sockets  
Steckschlüssel, Industrie-Ausführung  
Clés à douilles, finissage industriel **3/8"**

Z-SERIES  
HAND  
TITANIUM  
SCREWDRIVERS  
ACCESSORIES  
IMPACT  
SLEEVE-DRIVE  
PROTECTOR  
INDUSTRIAL  
AUTOMOTIVE  
MOTORCYCLE  
CONSTRUCTION  
SPARE PART

**23300M / 23300A**  6-point Sockets, deep  
6-kant Steckschlüssel, lang  
Douilles longues, 6-pans

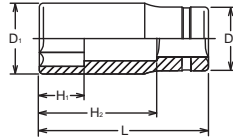

23300M (mm)	D <sub>1</sub> (mm)	D <sub>2</sub> (mm)	H <sub>1</sub> (mm)	H <sub>2</sub> (mm)	L (mm)	(g)	(pcs.)
7	10.6	17.4	8	41.5	55	40	10
8	12	17.4	9	41.5	55	45	10
10	14.5	17.4	11	41.5	55	52	10
11	16	17.2	12	41.5	55	55	10
12	16.8	17.2	13	41.5	55	58	10
13	18	17	14	41.5	55	57	10
14	20	18	16	41.5	55	68	10
15	21	20	16	40.5	55	78	10
16	22	20	17	40.5	55	79	10
17	23.5	22	18	40.5	55	96	10
18	24.5	23	19	39.5	55	96	10
19	25	24	20	39.5	55	102	10

23300A (inch)	D <sub>1</sub> (mm)	D <sub>2</sub> (mm)	H <sub>1</sub> (mm)	H <sub>2</sub> (mm)	L (mm)	(g)	(pcs.)
5/16	12	17.4	9	41.5	55	45	10
3/8	14	17.4	11	41.5	55	51	10
7/16	16	17.2	12	41.5	55	55	10
1/2	18	17	14	41.5	55	57	10
9/16	20	18	16	41.5	55	68	10
11/16	23.5	22	18	40.5	55	96	10
3/4	25	24	20	39.5	55	102	10

**23305M**  12-point Deep Sockets  
12-kant Steckschlüssel, lang  
Douilles longues 12-pans

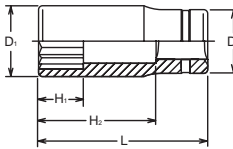

23305M (mm)	D <sub>1</sub> (mm)	D <sub>2</sub> (mm)	H <sub>1</sub> (mm)	H <sub>2</sub> (mm)	L (mm)	(g)	(pcs.)
8	12	17.4	9	41.5	55	45	10
10	14.5	17.4	11	41.5	55	52	10
12	16.8	17.2	13	41.5	55	58	10
14	20	18	16	41.5	55	68	10

**23310M**  Surface Drive Sockets, deep  
Surface Drive Steckschlüssel, lang  
Douilles longues, Surface Drive

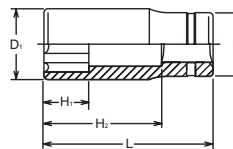

23310M (mm)	D <sub>1</sub> (mm)	D <sub>2</sub> (mm)	H <sub>1</sub> (mm)	H <sub>2</sub> (mm)	L (mm)	(g)	(pcs.)
8	12	17.4	9	41.5	55	45	10
10	14.5	17.4	11	41.5	55	52	10
12	16.8	17.2	13	41.5	55	58	10
13	18	17	14	41.5	55	57	10
14	20	18	16	41.5	55	68	10
15	21	20	16	40.5	55	80	10
17	23.5	22	18	40.5	55	96	10

**23325**  TORX® Deep Sockets  
TORX® Steckschlüssel, lang  
Douilles longues TORX®

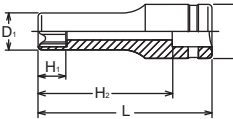

23325 (E)	D <sub>1</sub> (mm)	D <sub>2</sub> (mm)	H <sub>1</sub> (mm)	H <sub>2</sub> (mm)	L (mm)	(g)	(pcs.)
E 5	6.9	17.4	5.2	41.5	55	50	10
E 6	7.9	17.4	5.4	41.5	55	52	10
E 7	8.9	17.4	6.6	41.5	55	55	10
E 8	9.9	17.4	7	41.5	55	58	10
E10	11.8	17.2	8.2	41.5	55	60	10
E12	14.5	17.2	9.3	41.5	55	68	10
E14	15.7	17.2	10.6	41.5	55	77	10
E16	18	17	11.8	41.5	55	80	10

**23760-P** Extension Bars  
Verlängerungen  
Rallonges

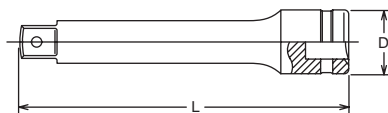

	D (mm)	L (mm)	(g)	(pcs.)
23760-75P	18	75	70	10
23760-125P	18	125	110	10
23760-250P	18	250	200	5

# 1/2"

Industrial Sockets  
Steckschlüssel, Industrie-Ausführung  
Clés à douilles, finissage industriel

24400M (mm)	D <sub>1</sub> (mm)	D <sub>2</sub> (mm)	H (mm)	L (mm)	(g)	(pcs.)
10	15.3	21	9	37	45	10
11	16.5	21	9.5	37	46	10
12	17.8	21	10	37	47	10
13	19	22	10.5	37	53	10
14	20.3	22	11	37	56	10
15	21.5	22	11.5	37	52	10
16	22.8	22	12	37	62	10
17	24.1	23	12.5	37	69	10
18	25.1	24	13	37	74	10
19	26.6	25	14	38	89	10
20	27.9	26	15	38	92	10
21	29.1	27	15.5	38	102	10
22	30.1	28	16	40	113	10
23	31.5	29	16.5	40	128	10
24	32.9	30	17	42	140	5
26	35	32	19	42	165	5
27	36.5	33	19.5	43	196	5
29	39	35	20.5	43	190	5
30	40	36	22	46	222	5
32	42.8	38	23	46	250	5

24400A (inch)	D <sub>1</sub> (mm)	D <sub>2</sub> (mm)	H (mm)	L (mm)	(g)	(pcs.)
7/16	16.5	21	9.5	37	46	10
1/2	19	22	10.5	37	53	10
9/16	20.3	22	11	37	56	10
5/8	22.9	22	12	37	62	10
3/4	26.6	25	14	38	89	10
15/16	32.9	30	17	42	140	10

24405M (mm)	D <sub>1</sub> (mm)	D <sub>2</sub> (mm)	H (mm)	L (mm)	(g)	(pcs.)
10	15.3	21	9	37	45	10
12	17.8	21	10	37	47	10
14	20.3	22	11	37	56	10
17	24.1	23	12.5	37	69	10
19	26.6	25	14	38	89	10

24410M (mm)	D <sub>1</sub> (mm)	D <sub>2</sub> (mm)	H (mm)	L (mm)	(g)	(pcs.)
10	15.3	21	9	37	45	10
12	17.8	21	10	37	47	10
13	19	22	10.5	37	53	10
14	20.3	22	11	37	56	10
15	21.5	22	11.5	37	52	10
16	22.8	22	12	37	62	10
17	24.1	23	12.5	37	69	10
18	25.1	24	13	37	74	10
19	26.6	25	14	38	89	10
21	29.1	27	15.5	38	102	10
22	30.1	28	16	40	113	10
24	32.9	30	17	42	140	10

24425 (E)	D <sub>1</sub> (mm)	D <sub>2</sub> (mm)	H (mm)	L (mm)	(g)	(pcs.)
E10	13.2	21	8.2	36	68	10
E12	14.6	21	9.3	37	70	10
E14	16.5	21	10.6	37	75	10
E16	19	21.9	11.8	37	80	10
E18	20.3	21.9	13	37	83	10
E20	22.9	22	14.4	37	121	10



## 24400M / 24400A

6-point Sockets  
6-kant Steckschlüssel  
Douilles 6-pans

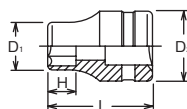

## 24405M

12-point Sockets  
12-kant Steckschlüssel  
Douilles 12-pans

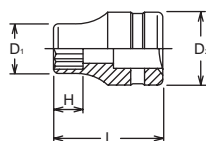

## 24410M

Surface Drive Sockets  
Surface Drive Steckschlüssel  
Douilles, Surface Drive

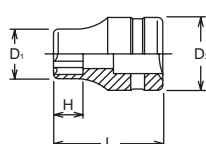

## 24425

TORX® Sockets  
TORX® Steckschlüssel  
Douilles TORX®

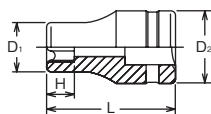

### TORX® (E)

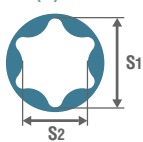

E	E4	E5	E6	E7	E8	E10	E11	E12	E14	E16	E18	E20	E22	E24	E26	E28	E30	E32
S <sub>1</sub> (ref. mm)	3.7	4.6	5.6	6.1	7.4	9.3	9.9	11.0	12.8	14.6	16.5	18.3	20.1	22.0	23.7	25.5	27.3	29.0
S <sub>2</sub> (ref. mm)	2.7	3.3	4.0	4.3	5.3	6.8	7.1	7.9	9.2	10.5	11.9	13.2	14.8	15.7	17.5	18.3	20.0	21.3

TORX is a registered trademark of Acument Intellectual Properties, LLC.  
TORX ist ein registriertes Markenzeichen der Firma Acument Intellectual Properties, LLC.  
TORX est une marque déposée de Acument Intellectual Properties, LLC.

# Industrial Sockets

## Steckschlüssel, Industrie-Ausführung

## Clés à douilles, finissage industriel

# 1/2"

Z-SERIES

HAND

TITANIUM

ACCESSORIES

SCREWDRIVERS

IMPACT

SLEEVE-DRIVE

PROTECTOR

INDUSTRIAL

AUTOMOTIVE

MOTORCYCLE

CONSTRUCTION

SPARE PART

### 24300M / 24300A

6-point Sockets, deep  
6-kant Steckschlüssel, lang  
Douilles longues, 6-pans

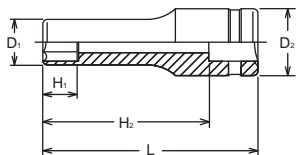

24300M (mm)	D <sub>1</sub> (mm)	D <sub>2</sub> (mm)	H <sub>1</sub> (mm)	H <sub>2</sub> (mm)	L (mm)	(g)	(pcs.)
10	15.3	21	11	59	77	91	10
11	16.5	21	12	59	77	95	10
12	17.8	21	13	59	77	99	10
13	19	21.8	14	59	77	107	10
14	20.3	21.8	16	59	77	118	10
15	21.5	21.8	16	59	77	123	10
16	22.8	22	17	59	77	141	10
17	24	23	18	59	77	150	10
18	25	24	19	59	77	164	10
19	26.5	25	20	58	77	177	10
20	27.8	26	21	58	77	178	10
21	29	27	23	58	77	187	10
22	30	28	27	57	77	202	10
24	32.8	30	27	57	77	252	10
27	36.5	33	28	56	77	303	10
30	40	36	34	55	77	342	10
32	42.8	38	34	55	77	405	10

24300A (inch)	D <sub>1</sub> (mm)	D <sub>2</sub> (mm)	H <sub>1</sub> (mm)	H <sub>2</sub> (mm)	L (mm)	(g)	(pcs.)
7/16	16.5	21	12	59	77	95	10
1/2	19	21.8	14	59	77	107	10
9/16	20.3	21.8	15	59	77	118	10
5/8	22.8	22	17	59	77	141	10
21/32	24	23	18	59	77	150	10
11/16	25	24	19	59	77	164	10
3/4	26.5	25	20	58	77	177	10
13/16	29	27	23	58	77	187	10
15/16	32.8	30	27	57	77	252	10

### 24305M

12-point Deep Sockets  
12-kant Steckschlüssel, lang  
Douilles longues 12-pans

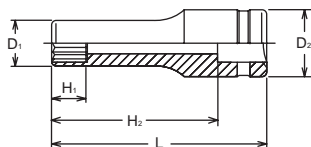

24305M (mm)	D <sub>1</sub> (mm)	D <sub>2</sub> (mm)	H <sub>1</sub> (mm)	H <sub>2</sub> (mm)	L (mm)	(g)	(pcs.)
10	15.3	21	11	59	77	91	10
12	17.8	21	13	59	77	99	10
14	20.3	21.8	16	59	77	118	10
17	24	23	18	59	77	150	10
19	26.5	25	20	58	77	177	10

### 24310M

Surface Drive Sockets, deep  
Surface Drive Steckschlüssel, lang  
Douilles longues, Surface Drive

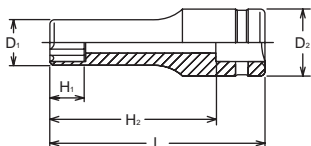

24310M (mm)	D <sub>1</sub> (mm)	D <sub>2</sub> (mm)	H <sub>1</sub> (mm)	H <sub>2</sub> (mm)	L (mm)	(g)	(pcs.)
10	15.3	21	11	59	77	91	10
12	17.8	21	13	59	77	99	10
13	19	21.8	14	59	77	107	10
14	20.3	21.8	16	59	77	118	10
15	21.5	21.8	16	59	77	123	10
16	22.8	22	17	59	77	141	10
17	24	23	18	59	77	150	10
18	25	24	19	59	77	160	10
19	26.5	25	20	58	77	177	10
21	29	27	23	58	77	187	10
22	30	28	27	57	77	202	10
24	32.8	30	27	57	77	250	10

### 24760-P

Extension Bars  
Verlängerungen  
Rallonges

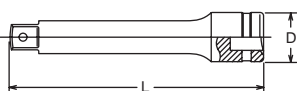

	D (mm)	L (mm)	(g)	(pcs.)
24760-75P	24	75	140	10
24760-125P	24	125	200	5
24760-250P	24	250	370	5

**AUTOMOTIVE TOOLS**  
**WERKZEUGE FÜR KFZ UND NUTZFAHRZEUGE**  
**OUTILS POUR POIDS LOURDS ET VÉHICULES UTILITAIRES**



Z-SERIES  
 HAND  
 TITANIUM  
 SCREWDRIVERS ACCESSORIES  
 IMPACT  
 SLEEVE-DRIVE  
 PROTECTOR  
 INDUSTRIAL  
 AUTOMOTIVE  
 MOTORCYCLE  
 CONSTRUCTION  
 SPARE PART

**3300C / 4300C** Spark Plug Sockets with Spring Clips  
 Zündkerzen-Schlüssel mit Haltefeder  
 Douille avec ressorts de retenue pour bougies

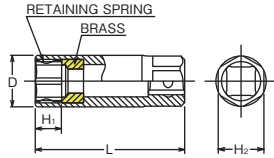

3300C (mm)	□	D (mm)	H <sub>1</sub> (mm)	H <sub>2</sub> (mm)	L (mm)	(g)	(pcs.)
13		17.5	11	17	70	66	10
14	3/8"	19	11	17	70	82	10
16		20.5	13	17	70	91	10
18		23.9	12	21	70	140	10
20.8		26.9	13.5	22	70	132	10

4300C (mm)	□	D (mm)	H <sub>1</sub> (mm)	H <sub>2</sub> (mm)	L (mm)	(g)	(pcs.)
16	1/2"	21	13	21	70	101	10
18		23.9	12	21	70	132	10
20.8		26.9	13.5	22	70	130	10

Spring clip type spark plug sockets caused deforming the clip if it would be used with shallow engagement.

**3300CB** Spark Plug Socket (BMW)  
 Zündkerzen-Schlüssel (BMW)  
 Douille pour bougies (BMW)

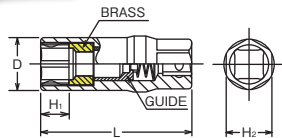

3300CB (mm)	□	D (mm)	H <sub>1</sub> (mm)	H <sub>2</sub> (mm)	L (mm)	(g)	(pcs.)
16	3/8"	22.8	13	19	65	118	10

Spring clip type spark plug sockets caused deforming the clip if it would be used with shallow engagement.

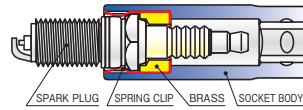

**SPARK PLUG SOCKETS with SPRING CLIP**  
 An internal brass guide holds the clips in place, which ensures perfect alignment of the spark plug into the threaded plug hole of the cylinder head, thus preventing thread damage.  
 The brass guide also eliminates stress loading and possible damage to the ceramic insulator of the spark plug.

**3305P** Spark Plug Socket with Magnet, 12-pt. opening  
 Zündkerzensteckschlüssel mit Magnet, 12-kant  
 Douille pour bougies, avec aimant, 12-pans

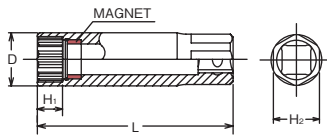

3305P (mm)	□	D (mm)	H <sub>1</sub> (mm)	H <sub>2</sub> (mm)	L (mm)	(g)	(pcs.)
14	3/8"	19	8	17	70	87	10
16		20.5	8	17	70	100	10

Spark Plug Socket with Magnet, 12-pt. opening: 3305P-14



The magnet could be broken with any impacts. Please handle with care.

**3300S / 4300S** Spark Plug Sockets with Rubber  
 Zündkerzen-Schlüssel mit Gummieinsatz  
 Douille pour bougies avec caoutchouc

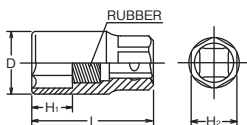

3300S (mm)	□	D (mm)	H <sub>1</sub> (mm)	H <sub>2</sub> (mm)	L (mm)	(g)	(pcs.)
16	3/8"	20.9	19	17	70	100	10
18		23.9	21	21	70	145	10
20.8		26.9	27	22	70	140	10

4300S (mm)	□	D (mm)	H <sub>1</sub> (mm)	H <sub>2</sub> (mm)	L (mm)	(g)	(pcs.)
16	1/2"	21	19	21	70	100	10
18		23.9	21	21	70	130	10
20.8		26.9	27	22	70	135	10



Z-SERIES  
 HAND  
 TITANIUM  
 ACCESSORIES  
 SCREWDRIVERS  
 IMPACT  
 SLEEVE-DRIVE  
 PROTECTOR  
 INDUSTRIAL  
 AUTOMOTIVE  
 MOTORCYCLE  
 CONSTRUCTION  
 SPARE PART

3300C-180 (mm)		D <sub>1</sub> (mm)	D <sub>2</sub> (mm)	H (mm)	L (mm)	(g)	(pcs.)
14	3/8"	19	18	11	180	205	5
16		20.5	18	13	180	220	5
20.8		26.9	18	13.5	180	260	5

3300C-250 (mm)		D <sub>1</sub> (mm)	D <sub>2</sub> (mm)	H (mm)	L (mm)	(g)	(pcs.)
14	3/8"	19	18	11	250	271	5
16		20.5	18	13	250	290	5
20.8		26.9	18	13.5	250	340	5

Spring clip type spark plug sockets caused deforming the clip if it would be used with shallow engagement.



### 3300C-180 / -250 Spark Plug Sockets with Spring Clips Zündkerzen-Schlüssel mit Haltefedern Douille avec ressorts de retenue pour bougies

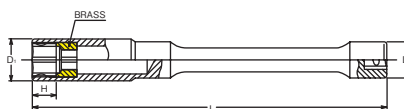

### 3305P-250

Spark Plug Socket with Magnet, 12pt. opening  
 Zündkerzensteckschlüssel mit Magnet, 12-kant  
 Douille pour bougies, avec aimant, 12-pans

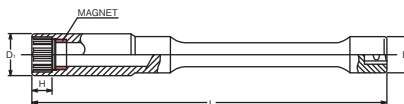

3305P-250 (mm)		D <sub>1</sub> (mm)	D <sub>2</sub> (mm)	H (mm)	L (mm)	(g)	(pcs.)
14	3/8"	19	18	8	250	250	5

The magnet could be broken with any impacts. Please handle with care.

3340C (mm)		D <sub>1</sub> (mm)	D <sub>2</sub> (mm)	H (mm)	L (mm)	(g)	(pcs.)
14	3/8"	19	19	11	88	109	10
16		21	19	13	88	122	10
18		23.9	19	12	88	145	10
20.8		26.8	19	13.5	88	174	10

4340C (mm)		D <sub>1</sub> (mm)	D <sub>2</sub> (mm)	H (mm)	L (mm)	(g)	(pcs.)
16	1/2"	21	25	13	100	220	10
20.8		26.8	25	13.5	100	250	10

Spring clip type spark plug sockets caused deforming the clip if it would be used with shallow engagement.

### 3340C Universal Spark Plug Sockets with Spring Clips Gelenk-Zündkerzenschlüssel mit Haltefeder Douille articulée avec ressorts de retenue pour bougies

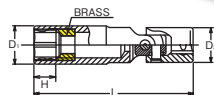

### 3345P Universal Spark Plug Socket with Magnet, 12-point opening Gelenk-Zündkerzensteckschlüssel mit Magnet, 12-kant Ausführung Clé pour bougies à déclenchement articulée avec aimant, 12 pans

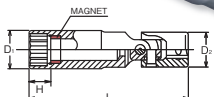

3345P (mm)		D <sub>1</sub> (mm)	D <sub>2</sub> (mm)	H (mm)	L (mm)	(g)	(pcs.)
14	3/8"	19	19	8	88	110	10

The magnet could be broken with any impacts. Please handle with care.



### 127C T-type Universal Spark Plug Socket Wrench T-Griff mit Gelenk-Zündkerzenschlüssel Poignée en T avec douille universelle pour bougies

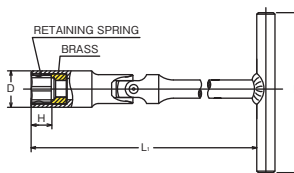
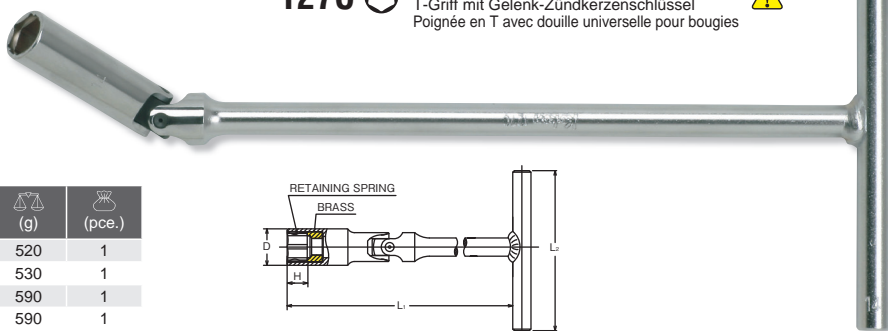

127C-315 (mm)	D (mm)	H (mm)	L <sub>1</sub> (mm)	L <sub>2</sub> (mm)	(g)	(pcs.)
14	19	11	315	150	520	1
16	21	13	315	150	530	1
18	23.9	12	315	150	590	1
20.8	26.8	13.5	315	150	590	1

Spring clip type spark plug sockets caused deforming the clip if it would be used with shallow engagement.

Z-SERIES  
 HAND  
 TITANIUM  
 SCREWDRIVERS ACCESSORIES  
 IMPACT  
 SLEEVE-DRIVE  
 PROTECTOR  
 INDUSTRIAL  
 AUTOMOTIVE  
 MOTORCYCLE  
 CONSTRUCTION  
 SPARE PART

**3751N** Torque Ratchet for Spark plugs  
 Drehmoment-Knarre für Zündkerzen  
 Cliquet pour bougies à déclenchement 25Nm



**TORQUE RATCHET**

The torque is set at 25Nm. When the torque is loaded higher than 25Nm, the gear slips and no increased torque is transmitted. Cylinder heads and spark plugs are protected by this mechanism.

**DREHMOMENT-KNARRE**

Die Knarre ist auf ein Drehmoment von 25Nm eingestellt. Ist das Drehmoment von 25Nm erreicht, springt das innere Getriebe über. Dies schützt die Zündkerzengewinde am Zylinderkopf.

**CLIQUET À DÉCLENCHEMENT**

Le cliquet est fixé à un torque d'une capacité maximale de 25NM. Une fois les 25NM atteints, ce mécanisme évite tout dépassement du cliquet.

**3751J** Torque Ratchet for Spark plugs  
 Drehmoment-Knarre für Zündkerzen  
 Cliquet pour bougies à déclenchement 25Nm

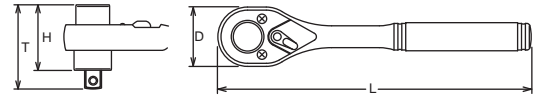

	□	D (mm)	T (mm)	H (mm)	L (mm)	(g)	(pce.)
3751N-25	3/8"	34	57	43	178	320	1
3751J-25	3/8"	34	57	43	178	320	1

**3225A** Set for Torque Controlled Installation of Spark Plugs  
 Set zur Drehmoment kontrollierten Montage von Zündkerzen  
 Jeu qui permet la rotation contrôlée lors du montage des bougies à déclenchement



3225A		4 Pieces Set/△=960g	
METAL CASE:W215xH80xT47mm			
Sockets		Accessories	
	3300C Spark Plug Sockets 16, 20.8		3751J-25
			3763-125

**3701-20Nm / -30Nm** Torque Adaptors 20Nm / 30Nm  
 Drehmoment-Verbindungsstücke 20Nm / 30Nm  
 Adaptateurs dynamométriques 20Nm / 30Nm



3701	□	D (mm)	L (mm)	(g)	(pce.)
20Nm	3/8"	25.5	75	178	1
30Nm	3/8"	28	75	220	1

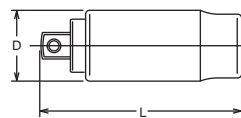

2350G-PSG (mm)		D <sub>1</sub> (mm)	D <sub>2</sub> (mm)	H <sub>1</sub> (mm)	H <sub>2</sub> (mm)	L (mm)	 (g)	 (pcs.)
12	1/4"	16.5	15.5	12	41	50	41	10



## 2350G-12PSG

NUT GRIP® Sockets for PSG-Glow Plugs  
Steckschlüssel für PSG-Glühkerzen  
Douille pour bougies PSG

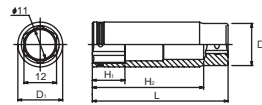

3341G-70 (mm)		D <sub>1</sub> (mm)	D <sub>2</sub> (mm)	H (mm)	L (mm)	 (g)	 (pcs.)
10	3/8"	14.5	19	6	70	76	10
11		15.8	19	6	70	80	10
12		17	19	6	70	85	10

## 3341G-70 / -89

Universal PSG Glow Plug Socket with NUT GRIP®  
Gelenksteckschlüssel für PSG-Glühkerzen mit 2fach Kugelhalterung  
Douille articulée pour bougies de préchauffement PSG, avec le système de billes de retenue, double.

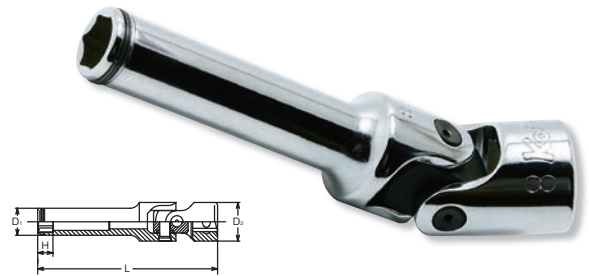

3341G-89 (mm)		D <sub>1</sub> (mm)	D <sub>2</sub> (mm)	H (mm)	L (mm)	 (g)	 (pcs.)
8	3/8"	12	19	7.5	89	82	10
9		13.3	19	7.5	89	87	10
10		14.5	19	6	89	92	10
12(DP52)		17	19	12	89	101	10

### GLOW PLUG SOCKETS, NUT GRIP®

Twin balls at the 6-point opening hold bolt/nut tightly for safe and reliable work.

Die zwei Kugeln in der 6-kant Öffnung unserer NUT GRIP® Glühkerzensteckschlüssel halten die Zündkerze sicher im Steckschlüssel. Dies erlaubt ein Arbeiten auch an schwer zugänglichen Stellen.

Les deux billes se trouvant dans l'ouverture de notre NUT GRIP® (6 pans) pour bougies de préchauffement, maintiennent la bougie de déclenchement dans la douille. Ceci permet l'accès dans les endroits difficilement accessibles.



## 3342G-150

Deep length universal Glow Plug Socket  
Extra langer Glühkerzen-Steckschlüssel mit Gelenk  
Douille articulée pour bougies de préchauffement, extra longue

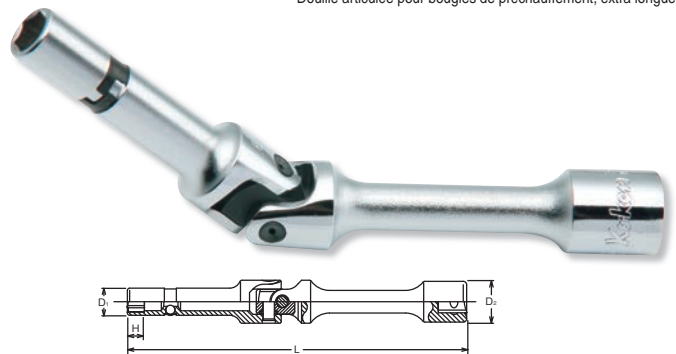

3342G-150 (mm)		D <sub>1</sub> (mm)	D <sub>2</sub> (mm)	H (mm)	L (mm)	 (g)	 (pcs.)
8	3/8"	12	18	7.5	150	137	10

## 144KM

For Glow Plugs  
Für Glühkerzen  
Pour bougies de préchauffement

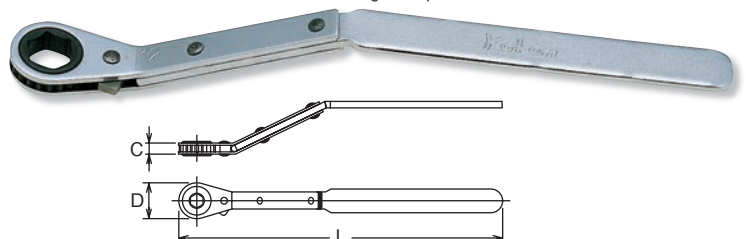

144KM (mm)	L (mm)	D <sub>1</sub> (mm)	D <sub>2</sub> (mm)	C (mm)	 (g)	 (pce.)
8	200	22.7	7.5	95	1	
12	200	22.7	7.5	102	1	

## 148KM

For Glow Plugs  
Für Glühkerzen  
Pour bougies de préchauffement

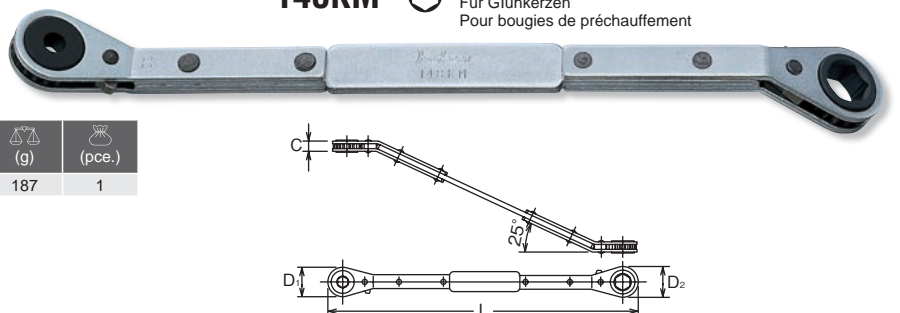

148KM (mm)	L (mm)	D <sub>1</sub> (mm)	D <sub>2</sub> (mm)	C (mm)	 (g)	 (pce.)
8Sx12	245	23.6	24.6	9	187	1

Z-SERIES  
 HAND  
 TITANIUM  
 SCREWDRIVERS ACCESSORIES  
 IMPACT  
 SLEEVE-DRIVE  
 PROTECTOR  
 INDUSTRIAL  
 AUTOMOTIVE  
 MOTORCYCLE  
 CONSTRUCTION  
 SPARE PART

**SP4305M-77**  Socket for Diesel engine injectors  
 Steckschlüssel für Diesel-Einspritzdüsen  
 Douilles spéciales pour injecteurs

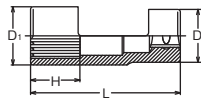
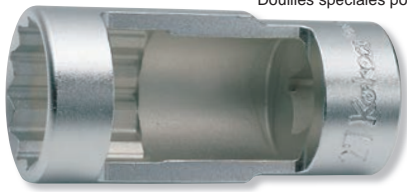

SP4305M-77 (mm)		D <sub>1</sub> (mm)	D <sub>2</sub> (mm)	H (mm)	L (mm)	(g)	(pcs.)
27	1/2"	36.5	33	28	77	212	10

**SP4305M-77-27**  
 For fuel injection pump of BMW diesel cars.

**4133**  Socket for Diesel engine injectors  
 Steckschlüssel für Diesel-Einspritzdüsen  
 Douilles spéciales pour injecteurs

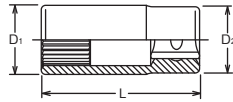

		D <sub>1</sub> (mm)	D <sub>2</sub> (mm)	L (mm)	(g)	(pcs.)
4133	1/2"	23.9	23	55	86	10

**4133**  
 For fuel injection pump of M.B diesel cars.

**4122-72** Diesel Injection Holder Nut Socket  
 Steckschlüssel für Einspritzdüsen  
 Douilles pour injecteur diesel

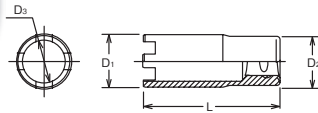

4122-72 (mm)		D <sub>1</sub> (mm)	D <sub>2</sub> (mm)	D <sub>3</sub> (mm)	L (mm)	(g)	(pcs.)
22	1/2"	28.5	27	22	72	150	10

**4122.72-22**  
 For M.B Trucks, Holder nut of injection post.

**SP4122-69** Diesel Injection Holder Nut Socket  
 Steckschlüssel für Einspritzdüsen  
 Douilles pour injecteur diesel

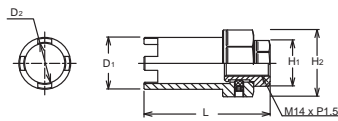

SP4122-69 (mm)	D <sub>1</sub> (mm)	D <sub>2</sub> (mm)	H <sub>1</sub> (mm)	H <sub>2</sub> (mm)	L (mm)	(g)	(pcs.)
22	28.4	22	22	32	69	185	5

**3300FN**  Flare Nut Sockets  
 Geschlitzte Steckschlüssel für Überwurfmutter  
 Douilles à tuyauteur

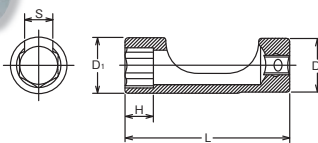
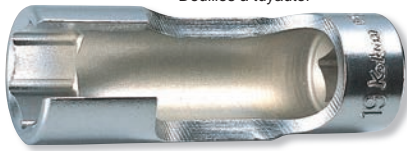

3300FN (mm)		D <sub>1</sub> (mm)	D <sub>2</sub> (mm)	H (mm)	L (mm)	S (mm)	(g)	(pcs.)
8	3/8"	14.5	17.3	6	53	6.4	38	10
9		16	17.3	7	53	6.8	41	10
10		16.8	17.2	7.5	53	7.2	42	10
11		18	17	8.5	53	8.3	42	10
12		20	18	9	53	8.8	50	10
13		21.1	20	9.5	62	9.4	66	10
14		22	20	10.5	62	10.5	66	10
15		23	22	11	70	11.5	82	10
16		24	23	11.5	70	12	90	10
17		25	24	12.5	80	13	110	10
18	27	25	13	80	13.5	120	10	
19	28	26	14	80	14.5	130	10	
22	32	29.5	16	80	16	180	10	
24	34.5	31.5	17	80	17	200	10	

RS3300FN/8	8 Pieces Set/Rail 200mm						(g)
	9, 10, 11, 13, 14, 16, 17, 19						600

**RS3300FN/8**   Socket Set on Rail  
 Steckschlüsselsatz auf Schiene  
 Jeu de douilles sur rail



**SP4300M-85**  Special socket for Lambda Probes  
 Spezialsteckschlüssel für Lambda Sonden  
**SP4300M-110**  Douilles spéciales pour sonde Lambda

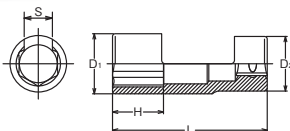
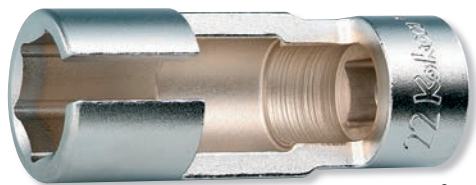

		D <sub>1</sub> (mm)	D <sub>2</sub> (mm)	H (mm)	L (mm)	S (mm)	(g)	(pcs.)
SP4300M.85-22	1/2"	33	30	29	85	8	228	10
SP4300M.110-22		33	30	34	110	8	279	5

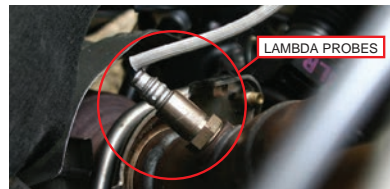

**Socket for Lambda Probes**  
 Open section allows for use with wire/connector.

4300H (mm)		D <sub>1</sub> (mm)	D <sub>2</sub> (mm)	H <sub>1</sub> (mm)	H <sub>2</sub> (mm)	H <sub>3</sub> (mm)	L (mm)	(g)	(pcs.)
24	1/2"	32.5	27	17	40	24	57	157	10
26		35	27	19	40	24	57	170	10
27		36.1	27	19.5	40	24	57	175	10

**4300H series**  
Removes and installs oil pressure switches

4300H (mm)		D <sub>1</sub> (mm)	D <sub>2</sub> (mm)	H <sub>1</sub> (mm)	H <sub>2</sub> (mm)	L (mm)	(g)	(pcs.)
<b>27(8P)</b>	1/2"	34	27	18.5	37	57	152	10

**4300H(8P) series**  
Socket for Switches, Mercedes Benz and MAN

4010M-100 (mm)		D (mm)	H (mm)	L (mm)	(g)	(pcs.)
<b>8(12P)</b>	1/2"	23	63.5	100	132	10
<b>10(12P)</b>		23	63.5	100	135	10

4010M-120 (mm)		D (mm)	H (mm)	L (mm)	(g)	(pcs.)
<b>8(12P)</b>	1/2"	23	83.5	120	151	10
<b>10(12P)</b>		23	83.5	120	155	10



**Cylinder head bolt socket for TOYOTA**  
4010M(12P) is Double Hex bit socket.  
XZN(Triple Square) bit socket has different shape.

		D (mm)	H (mm)	L (mm)	(g)	(pcs.)
<b>ST4027.140</b>	1/2"	23	103.5	140	155	10



**Head Bolt Bit Socket for VW/AUDI**  
ST4027-140 can not substitute with 3027, 4027-CV bit series.

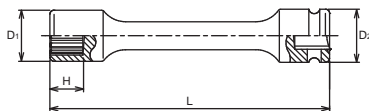

13145M-150 (12P) (mm)		D <sub>1</sub> (mm)	D <sub>2</sub> (mm)	H (mm)	L (mm)	(g)	(pcs.)	
<b>10</b>	3/8"	15.8	19	10	150	120	1	*1
<b>12</b>		18.3	19	12	150	128	1	*1

\*1 C-Ring=1301C, Pin/O-Ring=1301A+B → P254-255

16305M (mm)		D <sub>1</sub> (mm)	D <sub>2</sub> (mm)	H <sub>1</sub> (mm)	H <sub>2</sub> (mm)	L (mm)	(g)	(pcs.)	
<b>14</b>	3/4"	26.3	44	14	74	100	500	2	*1
<b>17</b>		30	44	17	74	100	544	2	*1
<b>19</b>		32.5	44	19	74	100	655	2	*1
<b>22</b>		36.3	44	22	74	100	700	2	*1

\*1 C-Ring=1600C, Pin/O-Ring=1601A+B → P254-255

**4300H** ○ Oil Pressure Switch Sockets  
Steckschlüssel für Öldruckschalter  
Douilles pour interrupteur, pression d'huile

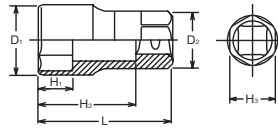

**4300H (8P)** ○ 8-point Sockets  
8-kant Steckschlüssel  
Douilles 8-pans

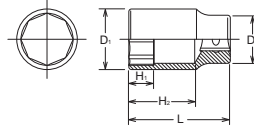

**4010M-100 / -120 (12P)**

● Bit Sockets for Double Inhex Screws (12-point)  
Steckschlüssel für Innenzwölfkant-Schrauben  
Douilles à 6-pans doubles

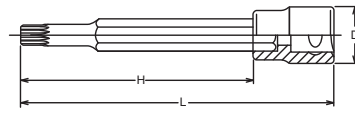

**ST4027-140** ● Head Bolt Bit Socket for VW/AUDI

Bit Steckschlüssel für Zylinderkopfschrauben VW/AUDI  
Douilles tournevis spéciales pour boulons de classe VW/AUDI

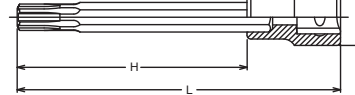

**13145M-150 / -200 (12P)** ○ Extra Long Sockets  
Schaftsteckschlüssel  
Douilles, série allongée



13145M.200 (12P) (mm)		D <sub>1</sub> (mm)	D <sub>2</sub> (mm)	H (mm)	L (mm)	(g)	(pcs.)	
<b>10</b>	3/8"	15.8	19	10	200	151	1	*1
<b>12</b>		18.3	19	12	200	159	1	*1

\*1 C-Ring=1301C, Pin/O-Ring=1301A+B → P254-255

**16305M** ○ 12-point Sockets, deep  
12-kant Steckschlüssel, lang  
Douilles longues, 12-pans

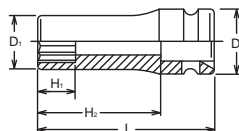

Z-SERIES  
 HAND  
 TITANIUM  
 SCREWDRIVERS ACCESSORIES  
 IMPACT  
 SLEEVE-DRIVE  
 PROTECTOR  
 INDUSTRIAL  
 AUTOMOTIVE  
 MOTORCYCLE  
 CONSTRUCTION  
 SPARE PART

**4109M**  Double 4-point Sockets  
 Doppelvierkant Steckschlüssel  
 Douilles 4-pans, doubles

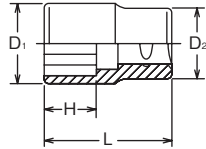

4109M (mm)		D <sub>1</sub> (mm)	D <sub>2</sub> (mm)	H (mm)	L (mm)	(g)	(pcs.)
14	1/2"	26.8	26	11	38	110	10
17		30	28	12.5	40	140	10
19		31.5	29	14	40	150	10
21.5		35	32	16	40	170	10
23		37	34	16.5	43	180	10

**4109M series**  
 For Lubrication service

**4111M**  6-point Sockets  
 6-kant Steckschlüssel  
 Douilles 6-pans

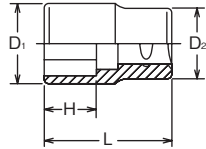

4111M (mm)		D <sub>1</sub> (mm)	D <sub>2</sub> (mm)	H (mm)	L (mm)	(g)	(pcs.)
24	1/2"	32	30	17	40	133	10

**4111M**  
 For Lubrication service

**4020-60 (MH)**  Bit Socket for XZN-Screws with hole  
 Steckschlüssel für XZN-Schrauben mit Loch  
 Douilles tournevis avec trou pour empreinte XZN

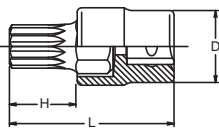

4020-60 (XZN)		D (mm)	H (mm)	L (mm)	(g)	(pcs.)
MH16	1/2"	24	20	60	135	10



**4020-60-MH16**  
 Specially designed for oil drain plug on gearbox of AUDI, VW, PORSCHE.

**3110M / 3110A**  4-point Male Sockets  
 Öldienst-Steckschlüssel  
 Douilles mâles 4-pans

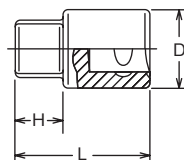



3110M (mm)		D (mm)	H (mm)	L (mm)	(g)	(pcs.)
6	3/8"	18	10	28	30	10
8		18	10	28	30	10
10		18	10	28	33	10
12		18	10	28	37	10

3110A (inch)		D (mm)	H (mm)	L (mm)	(g)	(pcs.)
5/16	3/8"	18	10	28	30	10
3/8		18	10	28	33	10
1/2		18	10	28	37	10

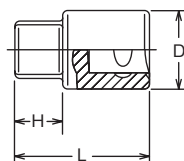
**4110M / 4110A**  4-point Male Sockets  
 Öldienst-Steckschlüssel, Vierkant  
 Douilles mâles 4-pans



4110M (mm)		D (mm)	H (mm)	L (mm)	(g)	(pcs.)
8	1/2"	24	10	32	57	10
10		24	10	32	62	10
10.5		24	10	32	64	10
12		24	10	32	64	10
13		24	10	32	66	10
13.5		24	10	32	67	10
19		25	15	37	101	10
20		26	15	37	114	10

4110A (inch)		D (mm)	H (mm)	L (mm)	(g)	(pcs.)
3/8	1/2"	24	10	32	62	10
1/2		24	10	32	64	10

**158**  For Lubrication Service  
Schmierdienst-Werkzeuge  
Service lubrification-vidange



158 (mm)	L <sub>1</sub> (mm)	L <sub>2</sub> (mm)	d (mm)	(g)	(pcs.)
<b>8Sx10S</b>	63	230	13	319	1

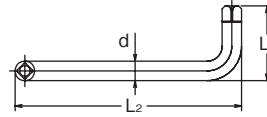

3012M-25 (mm)	(mm)	D (mm)	L (mm)	(g)	(pcs.)
<b>14</b>	<b>3/8"</b>	19	25	30	10
<b>17</b>		19	25	30	10

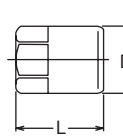

**3012M-25**  Inhex Sockets  
Steckschlüssel für Innensechskant-Schrauben  
Douilles tournevis pour vis 6-pans creux



**4202** 7 Pieces Set/  =426g

METAL CASE: W190xH59xT45mm

Sockets

-  **106 Drain Plug Keys**  
8Sx10S, 8Hx3/8H, 10Hx11H, 12Hx13H, 14Hx17H, 19H
-  **4102 Drain Plug Key Adaptor**

**4202** Drain Plug Keys Set  
Öldienst-Satz  
Jeu d'embouts pour le montage et démontage des bouchons de vidange



106 (mm)	H <sub>1</sub> (mm)	H <sub>2</sub> (mm)	H <sub>3</sub> (mm)	L (mm)	(g)	(pcs.)
<b>8Sx10S</b>	8	8	17	32	40	10
<b>8Hx3/8H</b>	8	8	17	32	38	10
<b>10Hx11H</b>	8	8	17	32	42	10
<b>12Hx13H</b>	8	8	17	32	47	10
<b>14Hx17H</b>	8	8	17	32	55	10
<b>19H</b>	-	8	17	24	49	10

**106**  4-point / 6-point Male bits  
Innenvierkant / Innensechskantsteckschlüssel  
Embouts mâles 4-pans / 6-pans

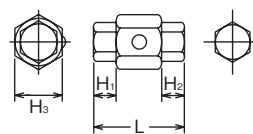

4102 (mm)	(mm)	D <sub>1</sub> (mm)	D <sub>2</sub> (mm)	H (mm)	L (mm)	(g)	(pcs.)
<b>17</b>	<b>1/2"</b>	25	24	16	40	82	10

**4102**  Adaptor for 106 Drain plug key  
Halter für Öldienst-Einsätze 106  
Porte embouts pour 106

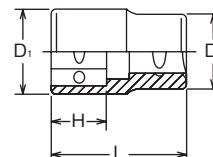

3400M-24 (mm)	(mm)	D <sub>1</sub> (mm)	D <sub>2</sub> (mm)	H (mm)	L (mm)	(g)	(pcs.)
<b>27</b>		36.5	21.5	13.5	24	76	10
<b>30</b>		40	25	13.5	24	91	10
<b>32</b>	<b>3/8"</b>	42.8	28	13.5	24	108	10
<b>36</b>		47.2	32	13.5	24	135	10

**3400M-24**  Extra short 6-point Sockets for Oil-Filter Service  
Extra kurze Steckschlüssel für Ölfilter  
Douille extra courte pour filtre à huile

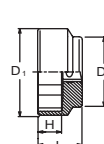

Z-SERIES  
 HAND  
 TITANIUM  
 SCREWDRIVERS ACCESSORIES  
 IMPACT  
 SLEEVE-DRIVE  
 PROTECTOR  
 INDUSTRIAL  
 AUTOMOTIVE  
 MOTORCYCLE  
 CONSTRUCTION  
 SPARE PART

**1206**  Push and Pull-Ratchet  
 Hub Knarre  
 Clé à cliquet de levage



<b>1206</b>		3 Pieces Set/△=320g	
CARDBOARD BOX			
Sockets		Accessory	
 <b>150.14H Sockets</b> 12, 14	<b>154K-14</b>		

**154K**  Push and Pull-Ratchets  
 Hub Knarre  
 Clé à cliquet de levage

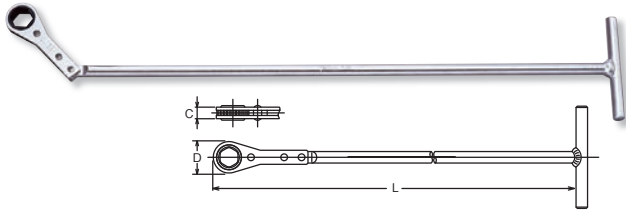

154K (mm)	L (mm)	D (mm)	C (mm)	(g)	(pcs.)
<b>14</b>	480	24.6	9	280	1

**150-14H**  Socket, For 154K  
 Einsätze für 154K  
 Douilles pour 154K



150-14H (mm)	D (mm)	H (mm)	L (mm)	(g)	(pcs.)
<b>10</b>	16	5	17	16	10
<b>12</b>	17.3	5	18	14	10
<b>14</b>	19.2	7	21	17	10

**145LH3/8F**  Belt Tension Pulley Wrench  
 Knarren-Ringschlüssel für Riemen-Spannrolle  
 Clé multicrân à cliquet pour galet-tendeur 

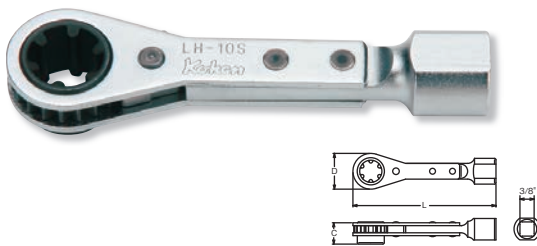

145LH3/8F (LH-S)		L (mm)	D (mm)	C (mm)	(g)	(pcs.)
<b>10S</b>	<b>3/8"</b>	100	25	15.5	90	10

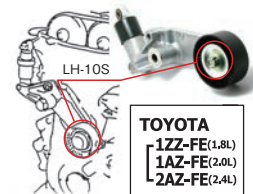

**Belt Tension Pulley Wrench**  
 For LH-10S bolt on TOYOTA engines 1ZZ (1.8L), 1AZ (2.0L) and 2AZ (2.4L), belt tension pulley.

**TOYOTA**  
**1ZZ-FE(1.8L)**  
**1AZ-FE(2.0L)**  
**2AZ-FE(2.4L)**

 This item has less strength due to the special design.

**4282** 1/2" Sq.Dr. Generator Service Set  
 1/2" Lichtmaschinen-Service Satz  
 Jeu 1/2" pour l'entretien des générateurs électriques



<b>4282</b>		4 Pieces Set/△=449g	
PLASTIC BAG			
Sockets			
 <b>1/2"</b>	<b>4020.100-M10</b> <b>4020.140-M10</b>		
 <b>1/2"</b>	<b>4025.100R-T50</b>		
	<b>185</b>		



**Generator Service Set**  
 For removing and installing belt pulley at the generator.



**1210E** Door Hinge Wrench Set  
Montagesatz für Kfz-Türscharniere  
Jeux d'outils spéciaux pour charnières de portes



1210E 11 Pieces Set/△=460g	
PLASTIC BAG	
Sockets	Accessory
<ul style="list-style-type: none"> <li>179B.12H Sockets 10, 12, 13</li> <li>179B.12H XZN Bits M8, M10, M12</li> <li>179B.12H TORX® Bits T40, T45, T50</li> <li>179B.12H Hex Bit 8</li> </ul>	145KD-12

**3247** 4 Pieces Set/△=385g  
PLASTIC BAG

**Sockets**

**3/8"** 3025.160 Tamper-resistant TORX® Bit Sockets T27H, T30H, T40H, T50H

**For Air Bag**  
For air-bag unit in hard to reach places in or around the steering wheel.

**Tamper Resistant TORX® Bit Sockets have less strength.**

**3247** Bit Socket Set  
Schraubendreher-Steckschlüssel Satz  
Jeu de douilles de vissage



**3300M/4-L120** 4 Pieces Set/△=477g  
PLASTIC BAG

**Sockets**

**3/8"** 3300M(L120) 6-pt. Extra Deep Sockets 8, 10, 12, 14

**Extra Deep Socket**  
Extra deep socket can be used to fasten or loosen longer bolts such as Bumper bolt and Door hinge etc.

**BUMPER BOLT**

**DEEP SOCKET**

**DOOR HINGE**

**EXTRA DEEP SOCKET**

**3300M/4-L120** Socket Set  
Steckschlüssel Satz  
Jeu de clés à douille



**3350M/2-L120** 2 Pieces Set/△=230g  
PLASTIC BAG

**Sockets**

**3/8"** 3350M(L120) Nut Grip Extra Deep Sockets 10, 12

**Nut Grip Extra Deep Socket**



**3350M/2-L120** Socket Set  
Steckschlüssel Satz  
Jeu de clés à douille



Z-SERIES  
 HAND  
 TITANIUM  
 SCREWDRIVERS ACCESSORIES  
 IMPACT  
 SLEEVE-DRIVE  
 PROTECTOR  
 INDUSTRIAL  
 AUTOMOTIVE  
 MOTORCYCLE  
 CONSTRUCTION  
 SPARE PART

**1212** Long shank Screwdriver 4 pieces set  
 Extra lange Schraubendreher 4teiliger Satz  
 Tournevis longs. Jeu de 4 pièces



**168T (250)** Extra long shank Screwdrivers  
 Extra lange Schraubendreher  
 Tournevis extra longs

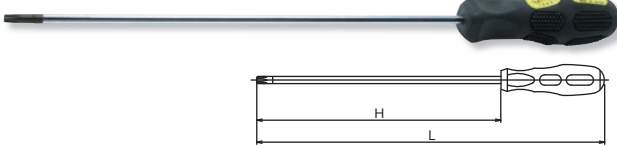

**169/2** Door Trim Pad Tool, 2 pieces set  
 Demontagehebel für Türclips, Satz 2-teilig  
 Jeu, levier pour le démontage des garnitures de portes

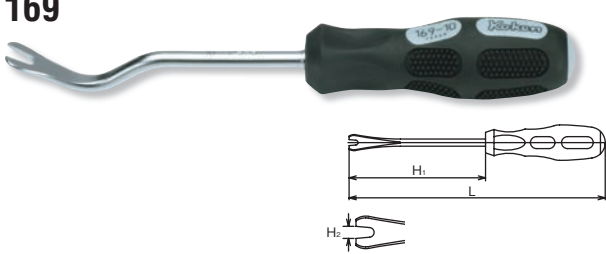

**169WM** Window Molding Remover  
 Zum Lösen von Fenstergummis  
 Pour le démontage des joints de vitres



**169HR/2** Hose Remover, 2 pieces set  
 Universalhaken, 2teiliger Satz  
 Pour le démontage des tuyaux. Jeu de 2 pièces



**169BP** For Battery Screws  
 Für Batterie-Verschlussstopfen  
 Pour vis de batterie



**1212** 4 Pieces Set/⚖️=380g  
 PLASTIC BAG

Screwdrivers					
168T(250)	20IPR				
168T(250)	T20, T25, T30				

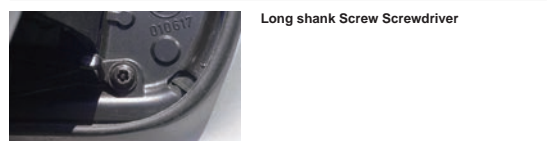

168T(250) (IPR)	H (mm)	L (mm)	(g)	(pcs.)
20IPR	250	350	85	1
168T(250) (T)	H (mm)	L (mm)	(g)	(pcs.)
T20	250	350	85	1
T25	250	350	85	1
T30	250	360	120	1

**169/2** 2 Pieces Set/⚖️=200g  
 PLASTIC BAG

Clip Handles					
169	6, 10				

169	H <sub>1</sub> (mm)	H <sub>2</sub> (mm)	L (mm)	(g)	(pcs.)
6	115	5	215	80	2
10	120	9	230	110	2



169WM	H (mm)	L (mm)	(g)	(pcs.)
169WM	100	210	90	2

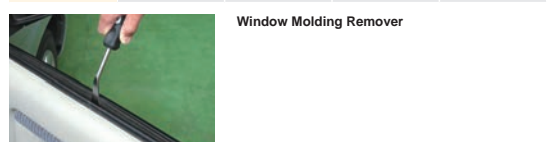

**169HR/2** 2 Pieces Set/⚖️=180g  
 PLASTIC BAG

Hose Remover					
169HR	A, B				

169HR	H (mm)	L (mm)	(g)	(pcs.)
A	100	200	75	2
B	100	200	90	2

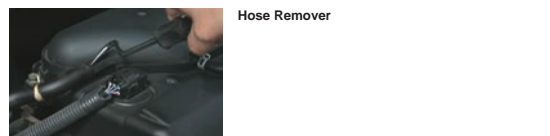

169BP	TxW (mm)	H (mm)	L (mm)	(g)	(pcs.)
1.8x13	1.8x13	50	150	60	2

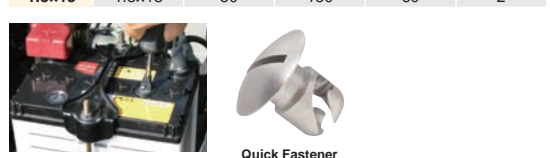

4425 (E)		D <sub>1</sub> (mm)	D <sub>2</sub> (mm)	H (mm)	L (mm)	(g)	(pcs.)
E10N		13.2	21	8.2	36	47	10
E12N		14.6	21	9.3	37	48	10
E14N		16.5	21	10.6	37	50	10
E16N		19	22	11.8	37	60	10
E18N		20.3	22	13	37	60	10
E20N		22.8	22	14.4	37	65	10

RS4425/6-N	6 Pieces Set/Rail 200mm	(g)
E10N, E12N, E14N, E16N, E18N, E20N		370



Engine type : QR/MR  
 Flywheel bolt for NISSAN E20N

13145A.150 (inch)		D <sub>1</sub> (mm)	D <sub>2</sub> (mm)	H (mm)	L (mm)	(g)	(pcs.)	
9/16(D20)		20	19	13	150	130	1	*1

\*1 C-Ring=1301C, Pin/O-Ring=1301A/B → P254-255

14145A.150 (inch)		D <sub>1</sub> (mm)	D <sub>2</sub> (mm)	H (mm)	L (mm)	(g)	(pcs.)	
9/16(D20)		20	25	13	150	200	1	*1

\*1 C-Ring=1401C, Pin/O-Ring=1401A/B → P254-255  
 For Land Rover Prop Shaft

13772-P		D <sub>1</sub> (mm)	D <sub>2</sub> (mm)	L (mm)	(g)	(pcs.)	
13772-P		22	19	75	120	5	*1
14772-P		27	25	90	230	1	*2

\*1 C-Ring=1301C, Pin/O-Ring=1301A/B  
 \*2 C-Ring=1401C, Pin/O-Ring=1401A/B → P254-255

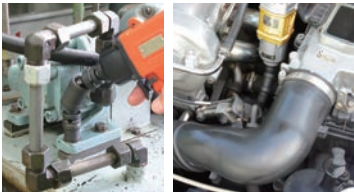

13772 and 14772 have less load capacity than standard. In the interest of your safety always use properly.

14305M (mm)		D <sub>1</sub> (mm)	D <sub>2</sub> (mm)	H <sub>1</sub> (mm)	H <sub>2</sub> (mm)	L (mm)	(g)	(pcs.)	
30		42	30	30	63	85	457	10	*2
32		44.5	30	32	63	85	542	10	*2
36		49.5	30	36	61	85	635	2	*2

\*2 C-Ring=1402C, Pin/O-Ring=1402A/B → P254-255



### 4425-N

TORX® Sockets  
 TORX® Steckschlüssel  
 Douilles TORX®

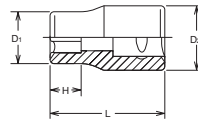

### RS4425/6-N

Socket Set on Rail  
 Steckschlüsselsatz auf Schiene  
 Jeu de douilles sur rail



### 13145A-150

Extra Long Socket  
 Schaftsteckschlüssel  
 Douilles, série allongée

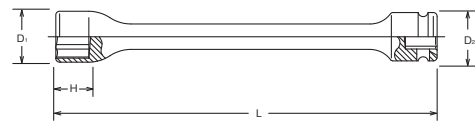

### 13772-P

Universal Double Joint  
 Doppelgelenk-Einsatz  
 Joint articulé double

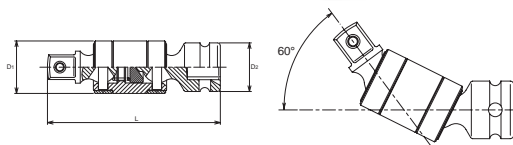

### 14305M

12-point Deep Sockets  
 12-kant Steckschlüssel, lang  
 Douilles longues 12-pans

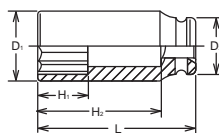

### 4101

Sockets for Slotted Heads  
 Steckschlüssel für Schlitzschrauben  
 Douilles tournevis pour vis à fente

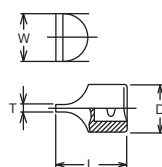

4101		TxW (mm)	D (mm)	L (mm)	(g)	(pcs.)
1		2.7x18.6	22	40	59	10
2		3.7x24	24	40	79	10
3		3.7x30	30	40	128	10

6101		TxW (mm)	D (mm)	L (mm)	(g)	(pcs.)
6101		6.4x33.5	35	50	205	5

TORX is a registered trademark of Acument Intellectual Properties, LLC.  
 TORX ist ein registriertes Markenzeichen der Firma Acument Intellectual Properties, LLC.  
 TORX est une marque déposée de Acument Intellectual Properties, LLC.

Z-SERIES  
 HAND  
 TITANIUM  
 SCREWDRIVERS ACCESSORIES  
 IMPACT  
 SLEEVE-DRIVE  
 PROTECTOR  
 INDUSTRIAL  
 AUTOMOTIVE  
 MOTORCYCLE  
 CONSTRUCTION  
 SPARE PART

### 4300M (L60)



Wheel Nut Sockets (Long)  
 Radmuttern-Steckschlüssel, extra lang  
 Douilles extra longues pour écrous de roue

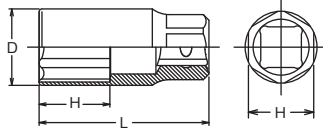

4300M(L60) (mm)		D (mm)	H (mm)	L (mm)	H (mm)	 (g)	 (pcs.)
17	1/2"	23.6	25	60	21	98	10
19		25.1	25	60	21	100	10
21		27.1	25	60	21	102	10



Wheel Nut Sockets

Please note that thin walled design is only for wheel nut work and Torque rating is limited.

### 4300M (L110)



Wheel Nut Sockets (Long)  
 Radmuttern-Steckschlüssel, extra lang  
 Douilles extra longues pour écrous de roue

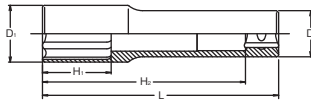

4300M(L110) (mm)		D <sub>1</sub> (mm)	D <sub>2</sub> (mm)	H <sub>1</sub> (mm)	H <sub>2</sub> (mm)	L (mm)	 (g)	 (pcs.)
17	1/2"	23	22	32	93	110	155	5
19		25.8	22	32	93	110	170	5
21		26.8	22	32	93	110	165	5

Please note that thin walled design is only for wheel nut work and Torque rating is limited.

### 4711X



Spinning cross wrench  
 T-Griff für die Radmuttermontage  
 Poignée coulissante pour montage des écrous à roue

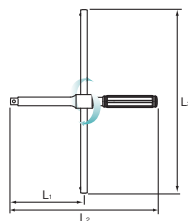

		L <sub>1</sub> (mm)	L <sub>2</sub> (mm)	L <sub>3</sub> (mm)	 (g)	 (pce.)
4711X	1/2"	140	280	350	945	1

14145PM-110 (mm)		D <sub>1</sub> (mm)	D <sub>2</sub> (mm)	H (mm)	Shaft Colour	(g)	(pcs.)	
17	1/2"	23.7	25.2	21	Blue	208	5	*1
19		25.7	27.2	23	Red	219	5	*1
21		27.5	29	25	Yellow	226	5	*1
22		29	30.5	26	White	238	5	*1



## 14145PM-110

Wheel Nut Sockets Set  
Radmuttern Steckschlüssel im Satz  
Douilles pour écrous de roue



### EXTRA THIN WALL EXTRA DÜNNWANDIG PAROIS EXTRA MINCES

Special design for wheel nut work.  
-110mm length gives socket extra reach for nuts recessed deep inside the wheel and ideal for Aluminum wheel nuts where access to nut is very tight.  
-Blue(17mm), Red(19mm), Yellow(21mm) and White(22mm) colour coded shafts make size identification easy.  
-Plastic insert helps prevent damaged to wheel nut.

Speziell entwickelt für die Montage von Radmuttern  
-Die Länge von 110mm erlaubt es mit diesem Steckschlüssel auch extra tiefe Radmuttern zu erreichen.  
-Dieser Steckschlüssel ist ideal für Radmuttern von Aluminiumfelgen, da gerade dort der Platz zwischen Schraube und Felge äußerst gering ist.  
-Durch die farbige Markierung; blau(17mm), Rot(19mm), Gelb(21mm) und Weiß(22mm) wird die Erkennung des passenden Werkzeugs erleichtert.  
-Der Plastikanschlag schützt die Radmutter vor Beschädigungen.

Douilles spécialement conçues pour les écrous de roue :  
-La longueur de 110mm permet d'atteindre les écrous enfoncés profondément.  
-Idéales pour les écrous des jantes en aluminium où le passage est souvent étroit  
-Les corps de couleurs différentes facilitent l'identification : bleu (17mm), rouge (19mm), jaune (21mm) et blanc (22mm)  
-Les inserts en plastique évitent de détériorer les jantes.

Please note that thin walled design is only for wheel nut work and Torque rating is limited.

\*1 C-Ring=1401C, Pin/O-Ring=1401A/B → P254-255

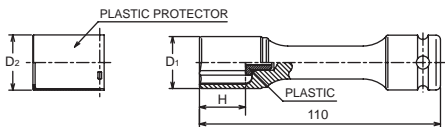

### PLASTIC PROTECTOR KUNSTSTOFF HÜLSE PROTECTION EN PLASTIQUE

A detachable plastic protector is fitted to the socket to prevent damage to the wheel when working in tight areas.  
The socket size and Ko-ken mark printed on the shaft makes it easier to see if the socket is still rotating or stopped.

Zum Schutz empfindlicher Leichtmetallfelgen ist eine drehbare und abnehmbare Kunststoff Hülse an dem Steckschlüssel montiert. Die aufgedruckten Markierungen am Werkzeugschaft zeigen außerdem ob das Werkzeug steht oder rotiert.

La douille est pourvue d'un insert en plastique détachable. Il sert à prévenir tout dommage aux jantes lors de l'utilisation des douilles.

Le marquage sur la tige rend l'identification des douilles très facile.

198-17	: Spare Plastic Protector for 14145PM.110-17	: 10 pcs.
198-19	: Spare Plastic Protector for 14145PM.110-19	: 10 pcs.
198-21	: Spare Plastic Protector for 14145PM.110-21	: 10 pcs.
198-22	: Spare Plastic Protector for 14145PM.110-22	: 10 pcs.

14201M	3 Pieces Set/📦=690g
CARDBOARD BOX:W125xH95xT34mm	
Sockets	
14145PM.110	Impact Wheel Nut Sockets
17, 19, 21	

280PM (mm)	D <sub>1</sub> (mm)	D <sub>2</sub> (mm)	H (mm)	L (mm)	H (mm)	Shaft Colour	(g)	(pcs.)
19	25.7	27.2	13	52	19	Red	150	5
21	27.5	29	13	55	21	Yellow	180	5



## 14201M

Wheel Nut Sockets  
Radmuttern Steckschlüssel  
Douilles pour écrous de roue



## 280PM

Adaptor Socket for Low Profile Wheel Nut  
Adapter Steckschlüssel für kurze Radmuttern  
Adaptateur pour des écrous de roue courts



Designed for Low Profile Wheel nut socket.

Detachable plastic protector is fitted to the adaptor to prevent damage to painted or surface treatment area on the wheel.  
The Plastic insert locate inside of the adaptor prevents damage to wheel nut.  
Colour coded band make size identification easy.

Die abnehmbare Kunststoffhülse schützt die Felge vor Kratzern oder Schrammen an der empfindlichen Oberfläche.  
Der Kunststoffanschlag im inneren des Werkzeugs schützt zusätzlich die Radmutter.  
Die Farbmarkierung macht die Identifikation des Werkzeugs einfach.

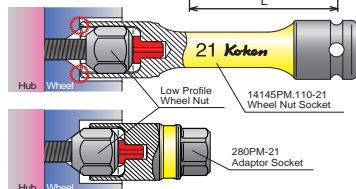
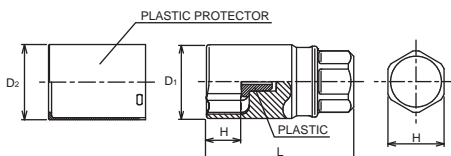

La protection plastifiée amovible, protège la jante et évite des dommages sur des surfaces délicates.  
Le plastic inséré à l'intérieur de l'outil protège également l'écrou de roue.  
L'identification de l'outil est simplifiée par le marquage en couleur.



Z-SERIES  
 HAND  
 TITANIUM  
 SCREWDRIVERS ACCESSORIES  
 IMPACT  
 SLEEVE-DRIVE  
 PROTECTOR  
 INDUSTRIAL  
 AUTOMOTIVE  
 MOTORCYCLE  
 CONSTRUCTION  
 SPARE PART

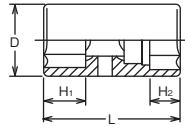
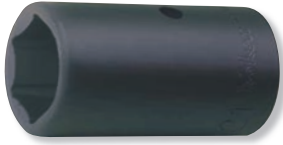

**14118M**  Wheel Nut Sockets, Double Ended  
 Radmuttern Steckschlüssel, doppelseitig  
 Douilles pour écrous de roue à ouvertures doubles



14118M (mm)		D (mm)	H <sub>1</sub> (mm)	H <sub>2</sub> (mm)	L (mm)	(g)	(pcs.)
17x19		28	15.5	13	48	150	10
19x21		31	17.5	13	57	177	10
19x22		31	17.5	15	57	187	10

**14218M**  Wheel Nut Sockets, Double Ended with Extension Bar  
 Radmuttern Steckschlüssel, doppelseitig, mit Verlängerung  
 Douille pour écrous de roue à ouvertures double plus rallonge





14218M		2 Pieces Set/  =360g	
CARDBOARD BOX			
Sockets		Accessory	
	1/2" 14118PM 19x21		14760ST-B

Interchangeable Wheel Nut Socket of 19mm and 21mm.

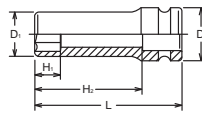
**AN14300**  Impact Sockets, Aluminium alloyed, for aluminium wheel nuts  
 Aluminium-legierte Impact Steckschlüssel für Aluminium Radmuttern  
 Douilles Impact en aluminium pour écrous de roue aluminium





AN14300 (mm)		D <sub>1</sub> (mm)	D <sub>2</sub> (mm)	H <sub>1</sub> (mm)	H <sub>2</sub> (mm)	L (mm)	(g)	(pcs.)	
17		25.7	30	17	62	80	85	10	*1
19		28.2	30	19	61	80	89	10	*1
21		30.7	30	21	61	80	93	10	*1

\*1 C-Ring=1402C, Pin/O-Ring=1402A/B → P254-255

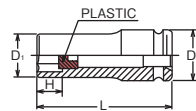
**14113J**  Impact Sockets with Plastic Stops for Hub Cap Screws  
 Impact Steckschlüssel mit Plastik-Anschlag für Zier-Radmuttern  
 Douilles Impact avec arrêt en plastique, pour écrous de roue décoratifs





14113J (mm)		D <sub>1</sub> (mm)	D <sub>2</sub> (mm)	H (mm)	L (mm)	(g)	(pcs.)	
17		25.7	30	14	80	251	10	*1
19		28.2	30	16	80	286	10	*1
21		30.7	30	20	80	309	10	*1

\*1 C-Ring=1402C, Pin/O-Ring=1402A/B → P254-255

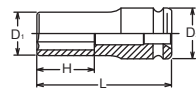
**14113M**  For Hub Cap Screws  
 Für Zier-Radmuttern  
 Pour écrous de roue décoratifs



14113M (mm)		D <sub>1</sub> (mm)	D <sub>2</sub> (mm)	H (mm)	L (mm)	(g)	(pcs.)	
17		25.7	30	34	80	230	10	*1
19		28.2	30	38	80	262	10	*1
21		30.7	30	42	80	285	10	*1

\*1 C-Ring=1402C, Pin/O-Ring=1402A/B → P254-255

14124 (mm)		D <sub>1</sub> (mm)	D <sub>2</sub> (mm)	H <sub>1</sub> (mm)	H <sub>2</sub> (mm)	L (mm)	 (g)	 (pcs.)
21x24.5	1/2"	28	29.5	24	25	65	157	10
26x27.5		31.5	35	24.5	24.5	65	197	10

**14124** Lock Nut Busters (Double Ended)  
Felgenschloss-Knacker, doppelseitig  
Douilles taraudées à ouvertures doubles pour  
dévisser les écrous ou goujons de roue antivols.

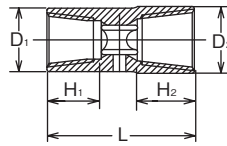

14124/3		3 Pieces Set/=580g
CARDBOARD BOX:W125xH91xT43mm		
Sockets	Accessory	
<b>14124</b> 21x24.5 26x27.5		<b>14760-75B</b>



**14124/3** Lock Nut Busters (Double Ended) in Set  
Felgenschloss-Knacker, doppelseitig im Satz  
Jeu de douilles taraudées à ouvertures doubles pour  
dévisser les écrous ou goujons de roue antivols.



14124 (mm)		D <sub>1</sub> (mm)	D <sub>2</sub> (mm)	H (mm)	L (mm)	 (g)	 (pcs.)	
17	1/2"	20.5	25	15	50	83	10	*1
18		21	25	15	50	83	10	*1
18.5		23	25	15	50	95	10	*1
19		25	30	20.5	50	140	10	*2
21		28	30	20.5	50	153	10	*2
24.5		29.5	30	23	50	138	10	*2
26		31.5	30	23	50	147	10	*2
27.5	35	30	23	50	181	10	*2	

\*1 C-Ring=1401C, Pin/O-Ring=1401A/B  
\*2 C-Ring=1402C, Pin/O-Ring=1402A/B P254-255

**14124** Lock Nut Busters  
Felgenschloss-Knacker  
Douilles taraudées pour dévisser les  
écrous ou goujons de roue antivols.

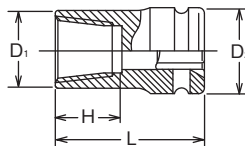

RS14124/7	7 Pieces Set/Rail 250mm	 (g)
18, 18.5, 19, 21, 24.5, 26, 27.5		980

**RS14124/7** Socket Set on Rail  
Steckschlüsselsatz auf Schiene  
Jeu de douilles sur rail



Z-SERIES  
 HAND  
 TITANIUM  
 SCREWDRIVERS ACCESSORIES  
 IMPACT  
 SLEEVE-DRIVE  
 PROTECTOR  
 INDUSTRIAL  
 AUTOMOTIVE  
 MOTORCYCLE  
 CONSTRUCTION  
 SPARE PART

**14112-P** Torsion Extension Bars (for tightening only)  
 Torsionsstab-Verlängerungen (nur zum Anziehen)  
 Barres de torsion (pour serrage seulement)

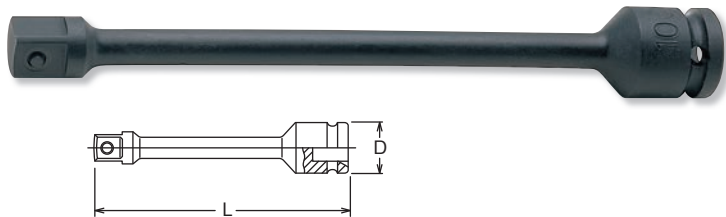

14112-P (Nm)		D (mm)	L (mm)			
90Nm	1/2"	25	208	206	1	*1
95Nm		25	202	200	1	*1
100Nm		25	196	198	1	*1
110Nm		25	213	220	1	*1
120Nm		25	201	219	1	*1
130Nm		25	205	225	1	*1
140Nm		25	205	230	1	*1
150Nm		25	195	250	1	*1
170Nm	25	195	257	1	*1	

\*1 C-Ring=1401C, Pin/O-Ring=1401A/B → P254-255

**14101MP** Torsion Bars (for tightening only)  
 Torsionsstäbe (nur zum Anziehen)  
 Barres de torsion (pour serrage seulement)

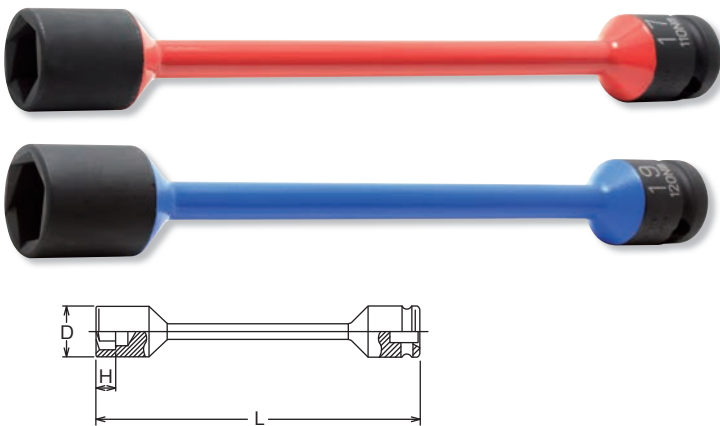

14101MP (mmxNm)		D (mm)	H (mm)	L (mm)	Shaft Colour		
17x 95Nm	1/2"	25.7	12	214	Yellow	10	*1
17x110Nm		25.7	12	204	Red	10	*1
17x120Nm		25.7	12	200	Green	10	*1
19x 90Nm		28.2	13	259	White	10	*1
19x100Nm		28.2	13	233	White	10	*1
19x120Nm		28.2	13	203	Blue	10	*1
19x140Nm		28.2	13	199	Orange	10	*1
21x100Nm		30.7	14	214	Black	10	*1
21x120Nm	30.7	14	203	Brown	10	*1	
22x150Nm	30.7	14	220	Purple	10	*1	

\*1 C-Ring=1401C, Pin/O-Ring=1401A/B → P254-255

As the torque could vary with the type and the condition of the impact wrench, we strongly recommend the control with a torque wrench.

Da die Drehmomentwerte von Art und Leistung des verwendeten Schlagschraubers abhängen, empfehlen wir die Kontrolle der Kombination Schlagschrauber/Torsionsstab mittels eines Drehmomentschlüssels.

Etant donné que le couple peut varier selon modèle, la capacité ou l'état de la clé à choc, le contrôle de la combinaison clé à choc/barre par clé dynamométrique est indispensable.

**14101MP-M/8** Metal-Wall-Hanger for Workshops  
 Werkstatt-Wandhänger (Metall)  
 Support métallique d'atelier



**14101MP-M/8** 8 Pieces Set/△=2,300g  
 HANGER

Torsion Bar  
**14101MP** Impact Torsion Bars  
 17x95Nm, 17x110Nm, 17x120Nm,  
 19x90Nm, 19x100Nm, 19x120Nm, 19x140Nm, 21x100Nm

Torque table included in delivery.  
 Drehmomenttabelle wird mitgeliefert.  
 Tableau des couples de serrage inclus dans la livraison.

**Torsion Bars**  
 - Designed for tightening wheel nuts with an impact wrench.  
 - Prevent the excessive torque road.  
 - Colour coded shafts make size identification easy.



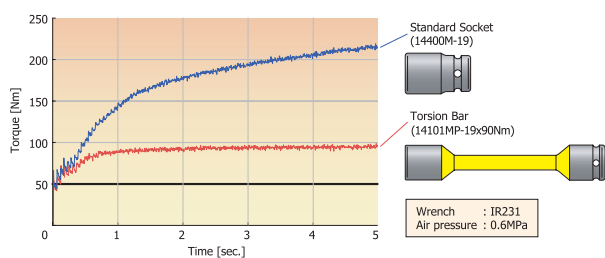

**Torsionsstäbe**  
 - Zur Montage von Radmutter mit dem Schlagschrauber.  
 - Schützt die Radmutter vor zu hohen Anzugsmomenten.  
 - Die Farbmarkierung erleichtert das Erkennen des passenden Werkzeugs.

**Barres de torsion**  
 - Pour le montage d'écrou de roue avec visseuse à chocs.  
 - Protège l'écrou d'un serrage à couple excessif.  
 - La colorisation des barres facilite l'identification des tailles.







Z-SERIES  
HAND  
TITANIUM  
ACCESSORIES  
SCREWDRIVERS  
IMPACT  
SLEEVE-DRIVE  
PROTECTOR  
INDUSTRIAL  
AUTOMOTIVE  
MOTORCYCLE  
CONSTRUCTION  
SPARE PART

14101M (mmxNm)		D (mm)	H (mm)	L (mm)			
14x 95Nm	1/2"	22	11	208	230	1	*1
15x110Nm		23.2	11	201	230	1	*1
17x 60Nm		25.7	12	216	227	1	*1
17x 75Nm		25.7	12	228	240	1	*1
17x 95Nm		25.7	12	214	256	1	*1
17x110Nm		25.7	12	204	285	1	*1
17x120Nm		25.7	12	200	284	1	*1
19x 60Nm		28.2	13	219	237	1	*1
19x 90Nm		28.2	13	259	275	1	*1
19x110Nm		28.2	13	214	278	1	*1
19x120Nm		28.2	13	203	297	1	*1
19x135Nm		28.2	13	206	339	1	*1
19x170Nm		28.2	13	190	332	1	*1
21x100Nm		30.7	14	214	288	1	*1
21x120Nm	30.7	14	203	288	1	*1	
22x160Nm	32	15	209	385	1	*1	

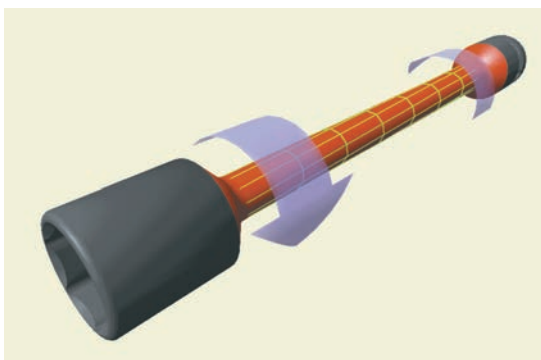
\*1 C-Ring=1401C, Pin/O-Ring=1401A/B → P254-255



 As the torque could vary with the type and the condition of the impact wrench, we strongly recommend the control with a torque wrench.

Da die Drehmomentwerte von Art und Leistung des verwendeten Schlagschraubers abhängen, empfehlen wir die Kontrolle der Kombination Schlagschrauber/Torsionsstab mittels eines Drehmomentschlüssels.

Etant donné que le couple peut varier selon modèle, la capacité ou l'état de la clé à choc, le contrôle de la combinaison clé à choc/barre par clé dynamométrique est indispensable.

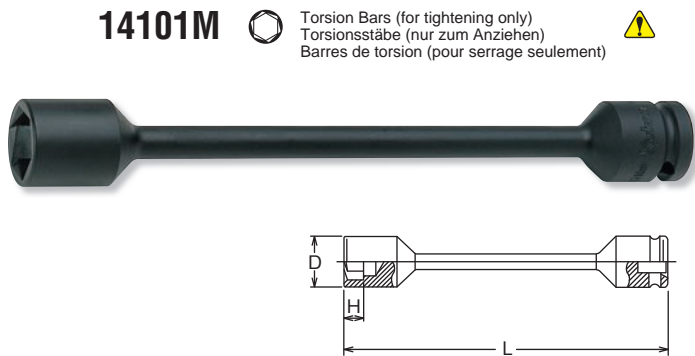

**14101M**  Torsion Bars (for tightening only)  
Torsionsstäbe (nur zum Anziehen)  
Barres de torsion (pour serrage seulement) 

**How to use Torsion Bar:**

1. Use with a 1/2" Sq. Dr. Pneumatic impact wrench.
2. Set air pressure 0.6MPa, and set impact wrench dial to Medium range.
3. Choose a suitable Torsion bar according to wheel nut size and indicated tightening torque.
4. Attach the torsion bar to impact wrench and apply load.
5. Check the actual tightening torque value with torque wrench.
6. Adjust air pressure or torque value according to the results of check 5.
7. Tight other wheel nut in diagonal order.



**Anwendung der Torsionsstäbe:**



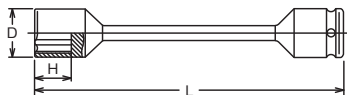

1. Verwendung mit Druckluft-Schlagschraubern mit 1/2" Anschlussvierkant.
2. Stellen Sie den Druck auf 6 Bar ein, und wählen Sie die mittlere Einstellung am Schlagschrauber.
3. Wählen Sie den passenden Torsionsstab (Kombination aus Schlüsselweite der Radschraube und Drehmoment) aus, und befestigen ihn am Gerät.
4. Ziehen Sie nun die Radmutter an, bis sich der Torsionsstab nicht weiter dreht.
5. Überprüfen Sie das Anzugsmoment mit dem Drehmomentschlüssel.
6. Passen Sie den Luftdruck bzw. die Einstellung am Schrauber dem Resultat der Drehmomentüberprüfung (Punkt 5.) an.
7. Ziehen Sie nun alle Radschrauben diagonal an.

**Conseils d'utilisation:**

1. A utiliser avec une visseuse à chocs pneumatique en carré entraînant 1/2".
2. Choisissez comme pression d'air 0.6MPa et ensuite la position moyenne de la visseuse.
3. Prenez une barre de torsion correspondant à l'ouverture du 6-pans de la vis ainsi qu'au couple nécessaire.
4. Serrez la vis jusqu'à l'arrêt de la barre de torsion.
5. Contrôlez le couple avec une clé dynamométrique.
6. Ajustez pression et/ou couple selon le résultat du contrôle sous 5.
7. Serrez toutes les vis en diagonale.



**16101M**  Torsion Bars (for tightening only)  
**18101M**  Torsionsstäbe (nur zum Anziehen)  
Barres de torsion (pour serrage seulement) 





16101M (mmxNm)		D (mm)	H (mm)	L (mm)			
24x180Nm	3/4"	38.8	24	235	850	1	*1
27x450Nm		42.5	27	280	1236	1	*1
32x600Nm		48.8	32	280	1370	1	*1
33x600Nm		50	33	280	1370	1	*1

\*1 C-Ring=1600C, Pin/O-Ring=1601A/B → P254-255

 As the torque could vary with the type and the condition of the impact wrench, we strongly recommend the control with a torque wrench.

Da die Drehmomentwerte von Art und Leistung des verwendeten Schlagschraubers abhängen, empfehlen wir die Kontrolle der Kombination Schlagschrauber/Torsionsstab mittels eines Drehmomentschlüssels.

Etant donné que le couple peut varier selon modèle, la capacité ou l'état de la clé à choc, le contrôle de la combinaison clé à choc/barre par clé dynamométrique est indispensable.

18101M (mmxNm)		D (mm)	H (mm)	L (mm)			
24x350Nm	1"	43.5	24	300	1380	1	*1
27x350Nm		47	27	300	1401	1	*1
27x450Nm		47	27	300	1579	1	*1
30x500Nm		51	30	300	1563	1	*1
32x450Nm		53.5	32	300	1600	1	*1
32x550Nm		53.5	32	300	1602	1	*1
32x600Nm		53.5	32	300	1602	1	*1
32x700Nm		51.5	32	300	1630	1	*1
33x550Nm		55	33	300	1638	1	*1
33x600Nm		55	33	300	1638	1	*1
36x600Nm		58.5	36	300	1718	1	*1

\*1 C-Ring=1801C, Pin/O-Ring=1801A/B → P254-255

Z-SERIES  
 HAND  
 TITANIUM  
 SCREWDRIVERS ACCESSORIES  
 IMPACT  
 SLEEVE-DRIVE  
 PROTECTOR  
 INDUSTRIAL  
 AUTOMOTIVE  
 MOTORCYCLE  
 CONSTRUCTION  
 SPARE PART

## 6102M-400 8102M-400

Extra long socket for wheel nuts  
 Extra lange Steckschlüssel für Radmuttern  
 Douilles extra-longues pour écrous de roue

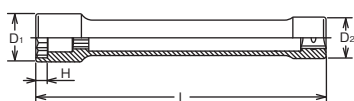

6102M-400 (mm)	□	D <sub>1</sub> (mm)	D <sub>2</sub> (mm)	H (mm)	L (mm)	⚖️ (g)	📦 (pce.)
41Wx21W	3/4"	58	40	14	400	1880	1
32		48.5	40	32	400	1480	1
33		49.8	40	32	400	1500	1

8102M-400 (mm)	□	D <sub>1</sub> (mm)	D <sub>2</sub> (mm)	H (mm)	L (mm)	⚖️ (g)	📦 (pce.)
41Wx21W	1"	58	49.9	14	400	2610	1
32		48.5	49.9	32	400	2210	1
33		49.8	49.9	32	400	2220	1

⚠️ 6102M/8102M are for hand use only. Do not use with a power tools.



Combination type  
41Wx21W

Extra long Socket for wheel nut

## 16102M-270 / -400 18102M-270 / -400



Extra long Sockets for wheel Nuts  
 Extra lange Steckschlüssel für Radmuttern  
 Douilles extra-longues pour écrous de roue

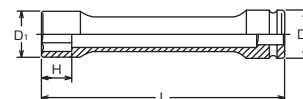

16102M-270 (mm)	□	D <sub>1</sub> (mm)	D <sub>2</sub> (mm)	H (mm)	L (mm)	⚖️ (g)	📦 (pce.)	⚡
24	3/4"	38.8	44	24	270	1034	1	*1
27		42.5	44	27	270	1088	1	*1
30		46.3	44	30	270	1144	1	*1
32		48.8	44	32	270	1157	1	*1
33		50	44	32	270	1200	1	*1
36		53.8	44	32	270	1250	1	*1
38		56.3	44	32	270	1610	1	*1
41		60	44	32	270	1640	1	*1

\*1 C-Ring=1600C, Pin/O-Ring=1601A/B → P254-255

16102M-400 (mm)	□	D <sub>1</sub> (mm)	D <sub>2</sub> (mm)	H (mm)	L (mm)	⚖️ (g)	📦 (pce.)	⚡
24	3/4"	38.8	44	24	400	1430	1	*1
27		42.5	44	27	400	1460	1	*1
30		46.3	44	30	400	1510	1	*1
32		48.8	44	32	400	1530	1	*1
33		50	44	32	400	1530	1	*1
36		53.8	44	32	400	2180	1	*1

\*1 C-Ring=1600C, Pin/O-Ring=1601A/B → P254-255

18102M-270 (mm)	□	D <sub>1</sub> (mm)	D <sub>2</sub> (mm)	H (mm)	L (mm)	⚖️ (g)	📦 (pce.)	⚡
23	1"	37.3	54	23	270	1627	1	*1
24		38.5	54	24	270	1628	1	*1
26		41	54	26	270	1667	1	*1
27		42.3	54	27	270	1680	1	*1
29		44.8	54	29	270	1680	1	*1
30		46	54	30	270	1680	1	*1
32		48.5	54	32	270	1680	1	*1
33		49.8	54	32	270	1700	1	*1
34		51	54	32	270	1750	1	*1
36		53.5	54	32	270	1750	1	*1
38		56	54	32	270	1822	1	*1
41		60	54	32	270	1800	1	*1

\*1 C-Ring=1801C, Pin/O-Ring=1801A/B → P254-255

18102M-400 (mm)	□	D <sub>1</sub> (mm)	D <sub>2</sub> (mm)	H (mm)	L (mm)	⚖️ (g)	📦 (pce.)	⚡
23	1"	37.3	54	23	400	1865	1	*1
24		38.5	54	24	400	1869	1	*1
26		41	54	26	400	1925	1	*1
27		42.3	54	27	400	2272	1	*1
29		44.8	54	29	400	2278	1	*1
30		46	54	30	400	2266	1	*1
32		48.5	54	32	400	2322	1	*1
33		49.8	54	32	400	2320	1	*1
34		51	54	32	400	2341	1	*1
36		53.5	54	32	400	2442	1	*1
38		56	54	32	400	2550	1	*1

\*1 C-Ring=1801C, Pin/O-Ring=1801A/B → P254-255

PW6 (mmxmm)		D <sub>1</sub> (mm)	D <sub>2</sub> (mm)	H (mm)	L (mm)	(g)	(pcs.)	
32x17	3/4"	47	44	12	75	633	2	*1
35x17		50	44	13	75	673	2	*1
38x20		55	44	14	75	708	2	*1
41x19		58	44	14	80	840	2	*1
41x20		58	44	14	80	840	2	*1
41x21		58	44	14	80	831	2	*1

\*1 C-Ring=1600C, Pin/O-Ring=1601A/B → P254-255

PW8 (mmxmm)		D <sub>1</sub> (mm)	D <sub>2</sub> (mm)	H (mm)	L (mm)	(g)	(pcs.)	
35x17	1"	50	54	13	83	935	2	*1
38x20		55	54	14	83	1038	2	*1
41x19		58	54	14	87	1100	2	*1
41x20		58	54	14	87	1096	2	*1
41x21		58	54	14	87	1089	2	*1

\*1 C-Ring=1801C, Pin/O-Ring=1801A/B → P254-255

SIZE	VEHICLE	SIZE	VEHICLE
32 x 17	TOYOTA (~2t)	41 x 19	MAZDA (3~4t)
35 x 17	NISSAN (~3t) MITSUBISHI (~4t) MAZDA (~2t) ISUZU (~3.5t)	41 x 20	TOYOTA (2t~) DAIHATSU (2~3.5t) HINO (2~3.5t)
38 x 20	MITSUBISHI (2~3.5t)	41 x 21	NISSAN (4t~) MITSUBISHI (2t~) ISUZU (4t~) HINO (4t~)

PW8P/4 4 Pieces Set/△=4,250g

CARDBOARD BOX:W240xH95xT70mm

Sockets

PW8P Impact Rear Wheel Nut Sockets  
35x17, 38x20, 41x19, 41x21

PW8P (mmxmm)		D <sub>1</sub> (mm)	D <sub>2</sub> (mm)	H (mm)	L (mm)	(g)	Shaft Colour	(pcs.)	
35x17	1"	50	54	13	83	935	White	5	*1
38x20		55	54	14	83	1038	Red	5	*1
41x19		58	54	14	87	1100	Green	5	*1
41x21		58	54	14	87	1089	Yellow	5	*1

\*1 C-Ring=1801C, Pin/O-Ring=1801A/B → P254-255

PW8L (mmxmm)		D <sub>1</sub> (mm)	D <sub>2</sub> (mm)	H (mm)	L (mm)	(g)	(pcs.)	
41x21	1"	58	54	15	105	1263	1	*1

\*1 C-Ring=1801C, Pin/O-Ring=1801A/B → P254-255

PS6 (mm)		D <sub>1</sub> (mm)	D <sub>2</sub> (mm)	H (mm)	L (mm)	(g)	(pcs.)	
17	3/4"	40	44	19	53	433	5	*1
19		40	44	19	53	419	5	*1
20		44	44	21	55	483	5	*1
21		44	44	23	57	491	5	*1

\*1 C-Ring=1600C, Pin/O-Ring=1601A/B → P254-255

PS8 (mm)		D <sub>1</sub> (mm)	D <sub>2</sub> (mm)	H (mm)	L (mm)	(g)	(pcs.)	
17	1"	40	54	19	60	621	2	*1
19		43	54	19	60	648	2	*1
20		45	54	21	62	687	2	*1
21		45	54	23	64	696	2	*1

\*1 C-Ring=1801C, Pin/O-Ring=1801A/B → P254-255

**PW6** Rear Wheel Nut Sockets  
Steckschlüssel für Hinterradmuttern  
Douilles spéciales pour écrous de roué arrière

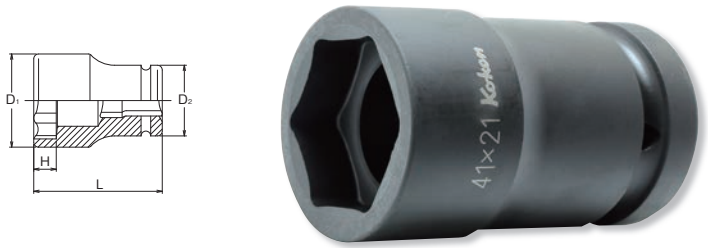

Tightening / Loosening Outer Nut

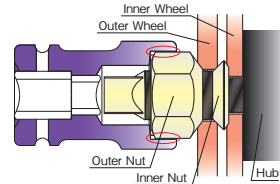

Tightening / Loosening Inner Nut

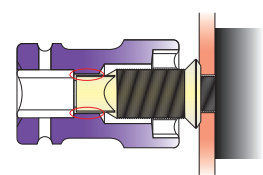

**PW8P/4** Socket set of Rear Wheel Nut Sockets  
Steckschlüssel für Hinterradmuttern, im Satz  
Jeu de douilles spéciales pour écrous de roué arrière



**PW8L** Rear Wheel Nut Socket (long)  
Steckschlüssel für Hinterradmuttern, lang  
Douilles spéciales pour écrous de roué arrière longue



**PS6** Rear Wheel Nut Sockets  
Steckschlüssel für Hinterradmuttern  
Douilles spéciales pour écrous de roué arrière

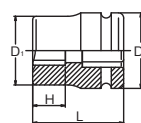

Z-SERIES  
 HAND  
 TITANIUM  
 SCREWDRIVERS ACCESSORIES  
 IMPACT  
 SLEEVE-DRIVE  
 PROTECTOR  
 INDUSTRIAL  
 AUTOMOTIVE  
 MOTORCYCLE  
 CONSTRUCTION  
 SPARE PART

### 14466A-200B 14488A-B / -200B

Adaptor  
Verbindungsstück  
Réducteur

No Warranty  
Keine Garantie  
Sans Garantie

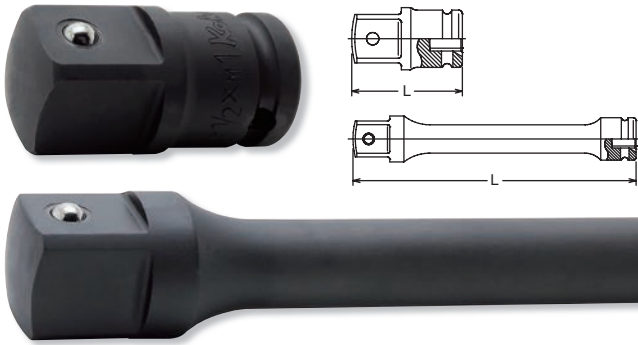
	□ (sq)	□ (sq)	L (mm)	⚖️ (g)	📦 (pce.)	⚡
14466A-200B	1/2"	3/4"	200	560	1	*2
14488A-B	1/2"	1"	58	280	1	*2
14488A-200B	1/2"	1"	200	660	1	*2

\*2 C-Ring=1402C, Pin/O-Ring=1402A/B ➔ P254-255



### 14466A-B / 14488A-B Impact Adaptors (□1/2" SQ. → □3/4", 1" SQ.)

For temporary fastening a wheel nut socket for large vehicle with a light duty 1/2" SQ. DR. Impact wrench.

 Socket is not completely locked with the Ball-type adaptor connection. Please beware of accidental socket release.

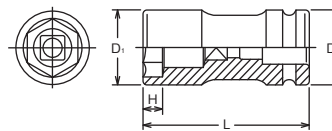

### 16316M / 16316A 18316M / 18316A

Rear Wheel Nut Sockets  
 Steckschlüssel für Hinterradmuttern  
 Douilles spéciales pour écrous de roué arrière



16316M (mmxmm)	□	D <sub>1</sub> (mm)	D <sub>2</sub> (mm)	H (mm)	L (mm)	⚖️ (g)	📦 (pce.)	⚡
35x17	3/4"	52	44	10	90	865	1	*1
38x20		56	44	13	100	952	1	*1
41x19		59	44	12	100	1037	1	*1
41x21		59	44	15	100	963	1	*1

\*1 C-Ring=1600C, Pin/O-Ring=1601A/B ➔ P254-255

18316M (mmxmm)	□	D <sub>1</sub> (mm)	D <sub>2</sub> (mm)	H (mm)	L (mm)	⚖️ (g)	📦 (pce.)	⚡
35x17	1"	52	54	10	108	1153	1	*1
38x20		56	54	13	108	1133	1	*1
41x19		59	54	12	108	1200	1	*1
41x21		59	54	15	108	1155	1	*1

\*1 C-Ring=1801C, Pin/O-Ring=1801A/B ➔ P254-255

16316A (inchxinch)	□	D <sub>1</sub> (mm)	D <sub>2</sub> (mm)	H (mm)	L (mm)	⚖️ (g)	📦 (pce.)	⚡
1.1/2x13/16	3/4"	56	44	13	100	940	1	*1

\*1 C-Ring=1600C, Pin/O-Ring=1601A/B ➔ P254-255

18316A (inchxinch)	□	D <sub>1</sub> (mm)	D <sub>2</sub> (mm)	H (mm)	L (mm)	⚖️ (g)	📦 (pce.)	⚡
1.1/2x13/16	1"	59	54	13	108	1120	1	*1

\*1 C-Ring=1801C, Pin/O-Ring=1801A/B ➔ P254-255

### 16317M / 16317A 18317M / 18317A

Rear Wheel Nut Sockets  
 Steckschlüssel für Hinterradmuttern  
 Douilles spéciales pour écrous de roué arrière

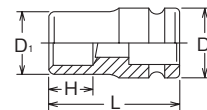

16317M (mm)	□	D <sub>1</sub> (mm)	D <sub>2</sub> (mm)	H (mm)	L (mm)	⚖️ (g)	📦 (pce.)	⚡
17	3/4"	40	44	22.5	67	485	1	*1
19		40	44	22.5	67	462	1	*1
20		44	44	22.5	67	517	1	*1
21		44	44	22.5	67	489	1	*1
22		44	44	22.5	67	482	1	*1

\*1 C-Ring=1600C, Pin/O-Ring=1601A/B ➔ P254-255

18317M (mm)	□	D <sub>1</sub> (mm)	D <sub>2</sub> (mm)	H (mm)	L (mm)	⚖️ (g)	📦 (pce.)	⚡
17	1"	40	54	22.5	72	682	1	*1
17.5		40	54	22.5	72	677	1	*1
19		43	54	22.5	72	705	1	*1
20		45	54	22.5	72	723	1	*1
20.5		45	54	22.5	72	723	1	*1
21		45	54	22.5	72	703	1	*1
22		45	54	22.5	72	696	1	*1

\*1 C-Ring=1801C, Pin/O-Ring=1801A/B ➔ P254-255

16317A (inch)	□	D <sub>1</sub> (mm)	D <sub>2</sub> (mm)	H (mm)	L (mm)	⚖️ (g)	📦 (pce.)	⚡
13/16	3/4"	44	44	22.5	67	489	1	*1

\*1 C-Ring=1600C, Pin/O-Ring=1601A/B ➔ P254-255

18317A (inch)	□	D <sub>1</sub> (mm)	D <sub>2</sub> (mm)	H (mm)	L (mm)	⚖️ (g)	📦 (pce.)	⚡
13/16	1"	45	54	22.5	72	703	1	*1

\*1 C-Ring=1801C, Pin/O-Ring=1801A/B ➔ P254-255





**MOTORCYCLE TOOLS**  
**MOTORRAD WERKZEUGE**  
**OUTILLAGE MOTO**

Z-SERIES  
 HAND  
 TITANIUM  
 ACCESSORIES  
 SCREWDRIVERS  
 IMPACT  
 SLEEVE-DRIVE  
 PROTECTOR  
 INDUSTRIAL  
 AUTOMOTIVE  
 MOTORCYCLE  
 CONSTRUCTION  
 SPARE PART

**4400M (DU)**  6 point Socket, extra short for Motorcycle central chain-wheel screws  
 6 kant Steckschlüssel, extra kurz für Motorrad Kettenrad-Zentralmuttern  
 Douille 6-pans, extra-court, pour moto, pour roue d'entraînement écrou-central





4400M		D <sub>1</sub> (mm)	D <sub>2</sub> (mm)	H (mm)	L (mm)	 (g)	 (pcs.)
41DU	1/2"	53	45	15	28	239	5
46DU		59	48	15	28	279	5

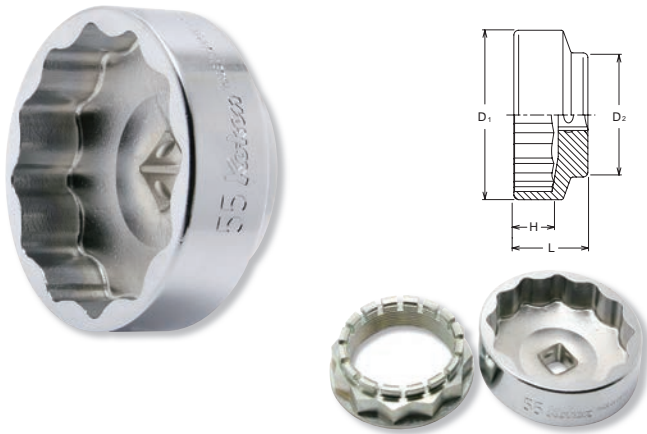

**4405M (DU)**  12 point Socket, extra short for motorcycle rear-axle screws  
 12 kant Steckschlüssel, extra kurz, für Motorrad-Hinterradmuttern  
 Douille 12-pans, extra-court, pour moto, pour écrou roue-arrière



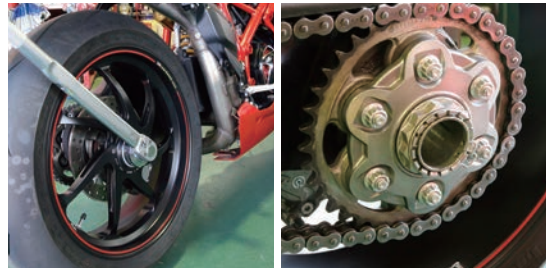

4405M		D <sub>1</sub> (mm)	D <sub>2</sub> (mm)	H (mm)	L (mm)	 (g)	 (pcs.)
36DU	1/2"	47.3	41	15	28	200	5
55DU		71	52	16	31	410	5

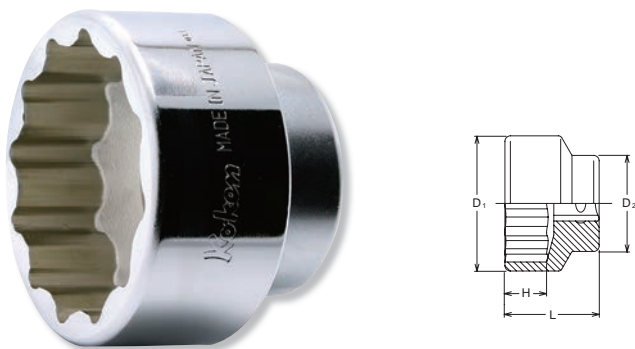

**6405A (MV)**  12 point Socket, extra short for motorcycle rear-axle screws  
 12 kant Steckschlüssel, extra kurz, für Motorrad-Hinterradmuttern  
 Douille 12-pans, extra-court, pour moto, pour écrou roue-arrière





6405A		D <sub>1</sub> (mm)	D <sub>2</sub> (mm)	H (mm)	L (mm)	 (g)	 (pcs.)
2.3/16MV	3/4"	74.6	53	23	52	790	2



**4012M-43**  Inhex Sockets  
 Steckschlüssel für Innensechskant-Schrauben  
 Douilles tournevis pour vis 6-pans creux



4012M-43 (mm)		D (mm)	H (mm)	L (mm)	 (g)	 (pcs.)
20	1/2"	26	11.5	43	130	10
21		26	11.5	43	140	10
22		26	11.5	43	145	10
23		28	11.5	43	170	10
24		28	11.5	43	170	10
27		32	11.5	43	226	10



Z-SERIES  
 HAND  
 TITANIUM  
 ACCESSORIES  
 SCREWDRIVERS  
 IMPACT  
 SLEEVE-DRIVE  
 PROTECTOR  
 INDUSTRIAL  
 AUTOMOTIVE  
 MOTORCYCLE  
 CONSTRUCTION  
 SPARE PART

155	D (mm)	d (mm)	L (mm)	(g)	(pcs.)
	22	10	170	100	10

For Motorcycles  
 Für Motorräder  
 Pour motos

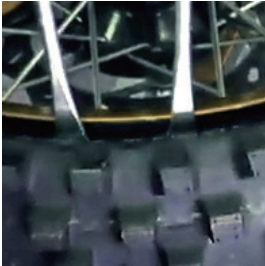

**155** Tyre Lever  
 Reifen und Montagehebel  
 Démonte-pneu

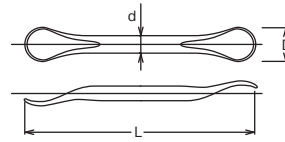

104ME (mm)	D (mm)	H (mm)	L <sub>1</sub> (mm)	L <sub>2</sub> (mm)	(g)	(pce.)
6	9.5	8	200	180	150	1
7	11	9	200	180	152	1
8	12	10	250	200	183	1
9	14	12	250	200	188	1
10	14	13	250	200	230	1
11	16	14	250	200	234	1
12	18	15	250	200	355	1
13	18.5	17	250	250	390	1
14	20	18	250	250	399	1
15	21	19	250	250	404	1
16	22.5	21	250	250	419	1
17	24	22	250	250	568	1
18	25	23	250	250	577	1
19	26.5	25	250	250	594	1

**104ME** T-Handles, 6-Point  
 T-Griffe, 6-kant  
 Poignées en T, 6-pans

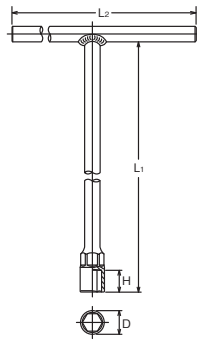

157HE (mm)	L <sub>1</sub> (mm)	L <sub>2</sub> (mm)	(g)	(pce.)
3	250	180	98	1
4	250	180	121	1
5	250	180	158	1
6	250	180	416	1
8	250	180	422	1
10	300	190	440	1
12	320	210	660	1

157PE (PH)	L <sub>1</sub> (mm)	L <sub>2</sub> (mm)	(g)	(pce.)
2	250	180	95	1
3	250	180	170	1

157T (T)	L <sub>1</sub> (mm)	L <sub>2</sub> (mm)	(g)	(pce.)
T25	250	180	95	1
T27	250	180	96	1
T30	250	180	167	1
T40	250	180	168	1
T45	250	180	213	1
T50	250	180	215	1

**157HE** T-Handles, for Inhex Screws  
 T-Griffe für Innensechskant-Schrauben  
 Poignées en T, pour vis à 6-pans creux

**157PE** T-Handles for Phillips Screws  
 T-Griffe für Kreuzschlitzschrauben Phillips  
 Poignées en T, pour vis à empreinte Phillips

**157T** T-Handle for TORX® Screws  
 T-Griff für TORX®-Schrauben  
 Poignées en T pour vis à empreinte TORX®

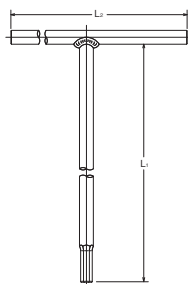

Z-SERIES  
 HAND  
 TITANIUM  
 ACCESSORIES  
 SCREWDRIVERS  
 IMPACT  
 SLEEVE-DRIVE  
 PROTECTOR  
 INDUSTRIAL  
 AUTOMOTIVE  
 MOTORCYCLE  
 CONSTRUCTION  
 SPARE PART

**2263A** 1/4" Socket set (Inch)  
 1/4" Steckschlüsselsatz (Zoll)  
 1/4" Jeu de clés à douilles (Pouce)



2263A		29 Pieces Set/△=940g	
METAL CASE:W240xH100xT32mm			
Sockets		Accessories	
	<b>2400A</b> 6-pt. Sockets 1/8, 5/32, 3/16, 7/32, 1/4, 9/32, 5/16, 11/32, 3/8, 7/16, 1/2		<b>2753N</b>
	<b>2000.28</b> Bit Sockets 1, 2, 3		<b>2760-100</b>
	<b>2010A.25</b> Bit Sockets 1/8, 5/32, 3/16, 7/32, 1/4, 9/32, 5/16		<b>2769N-150</b>
	<b>2025.28</b> Bit Sockets T10, T15, T20, T25, T30		<b>2770</b>
			<b>2785</b>

**3201AMW** 3/8" Socket set (mixed Metric,Inch,Witworth)  
 3/8" Steckschlüsselsatz (gemischt Metrisch,Zoll.)  
 Jeu de douilles 3/8" (pouce et métrique)



3201AMW		42 Pieces Set/△=4,700g	
METAL CASE:W445xH190xT50mm			
Sockets		Accessories	
	<b>3405M</b> 12-pt. Sockets 9, 10, 11, 12, 13, 14, 15, 16, 17, 18, 19, 20, 21, 22		<b>3753N</b>
	<b>3405A</b> 12-pt. Sockets 5/16, 3/8, 7/16, 1/2, 9/16, 5/8, 11/16, 3/4, 25/32, 13/16, 7/8		<b>3760-75</b>
	<b>3405W</b> 12-pt. Sockets 1/8, 3/16, 1/4, 5/16, 3/8, 7/16, 1/2		<b>3760-125</b>
			<b>3760-250</b>
			<b>3768N-250</b>
			<b>3769N-160</b>
			<b>3770</b>
			<b>3780</b>
			<b>3785</b>
			<b>3344A</b>

**4238AM** 1/2" Socket set (mixed Metric,Inch)  
 1/2" Steckschlüsselsatz (gemischt Metrisch,Zoll)  
 Jeu de douilles 1/2" (pouce et métrique)



4238AM		38 Pieces Set/△=8,050g	
METAL CASE:W446xH266xT50mm			
Sockets		Accessories	
	<b>4405M</b> 12-pt. Sockets 10, 11, 12, 13, 14, 15, 16, 17, 18, 19, 21, 22, 23, 24, 26, 27, 30, 32		<b>4753N</b>
	<b>4405A</b> 12-pt. Sockets 3/8, 7/16, 1/2, 9/16, 5/8, 11/16, 3/4, 13/16, 7/8, 15/16, 1.1/16, 1.1/8, 1.1/4		<b>4760-125</b>
	<b>4300C</b> Spark Plug Socket 20.8		<b>4760-250</b>
			<b>4770</b>
			<b>4780</b>
			<b>4785</b>

**4251A** 1/2" Socket set (Inch)  
 1/2" Steckschlüsselsatz (Zoll)  
 Jeu de douilles (pouce) 1/2"



4251A		18 Pieces Set/△=2,660g	
METAL CASE:W330xH68xT48mm			
Sockets			
	<b>4405A</b> 12-pt. Sockets 3/8, 7/16, 1/2, 9/16, 5/8, 19/32, 21/32, 11/16, 3/4, 25/32, 13/16, 7/8, 15/16, 1, 1.1/16, 1.1/8, 1.3/16, 1.1/4		



**TOOLS FOR CONSTRUCTION SITES  
WERKZEUGE FÜR DAS BAUWERBE  
OUTILLAGE POUR L'INDUSTRIE DU BÂTIMENT**



Z-SERIES  
 HAND  
 TITANIUM  
 ACCESSORIES  
 SCREWDRIVERS  
 IMPACT  
 SLEEVE-DRIVE  
 PROTECTOR  
 INDUSTRIAL  
 AUTOMOTIVE  
 MOTORCYCLE  
 CONSTRUCTION  
 SPARE PART

**BD014SE** ○ 12-point Nut Setters  
 12-kant Steckschlüsselklingen  
 Douilles 12-pans à embout

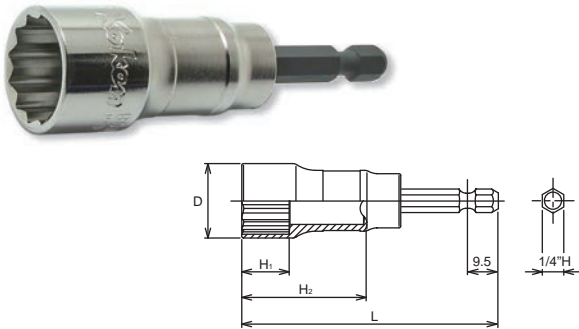

BD014SE (mm)	D (mm)	H <sub>1</sub> (mm)	H <sub>2</sub> (mm)	L (mm)	(g)	(pcs.)
8	12	12	36	77	35	10
10	14	12	36	77	38	10
12	16.5	14	36	77	48	10
13	17.5	14	36	77	51	10
14	19	14	36	77	54	10
17	22.5	14	36	77	76	10
19	24.5	14	36	77	83	10
21	27	14	34	77	104	10
22	28	14	34	77	120	10
24	30.3	14	34	77	140	10

● DIN 3126 Form E 6.3

**BD014E** ○ 12-point Nut Setters, deep  
 12-kant Steckschlüsselklingen, lang  
 Douilles longues, 12-pans à embout

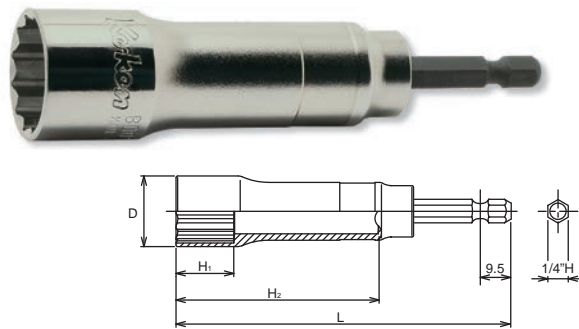

BD014E (mm)	D (mm)	H <sub>1</sub> (mm)	H <sub>2</sub> (mm)	L (mm)	(g)	(pcs.)
8	12	12	63	104	45	10
10	14	12	63	104	52	10
12	16.5	18	63	104	61	10
13	17.5	18	63	104	65	10
14	19	18	63	104	72	10
17	22.5	18	60	104	80	10
19	24.5	18	60	104	95	10
21	27	18	60	104	110	10
22	28	18	60	104	112	10
24	30.3	18	60	104	123	10

● DIN 3126 Form E 6.3

**BD014E-140** ○ 6-point Nut Setters, extra deep  
 6-kant Steckschlüsselklingen, extra lang  
 Douilles extra-longues, 6-pans à embout

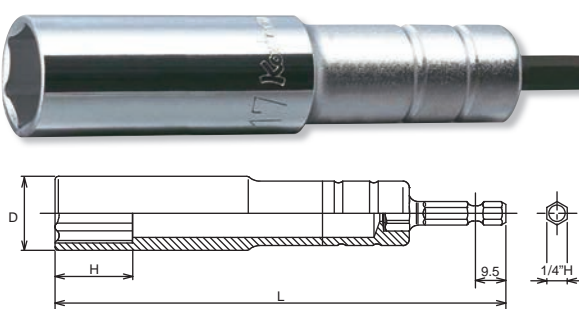

BD014E-140 (mm)	D (mm)	H (mm)	L (mm)	(g)	(pcs.)
13	19	20	140	120	10
17	24	26	140	190	10

● DIN 3126 Form E 6.3

BD014XE (mm)	D (mm)	H <sub>1</sub> (mm)	H <sub>2</sub> (mm)	L (mm)	(g)	(pcs.)
8SF	13	12	49	90	40	10
10SF	15	12	49	90	46	10
12SF	17.5	14	48	90	54	10
13SF	18.5	14	48	90	58	10
14SF	19.8	14	47	90	64	10
17SF	23.5	14	46	90	81	10
19SF	25.5	14	46	90	100	10
21SF	28	14	46	90	123	10
24SF	31.5	14	45	90	137	10

◆ DIN 3126 Form E 6.3



### BD014XE-SF

Surface Drive Nut Setters, Semi-Deep  
Surface Drive Steckschlüsselklingen, mittel lang  
Douilles semi-profondes, Surface Drive

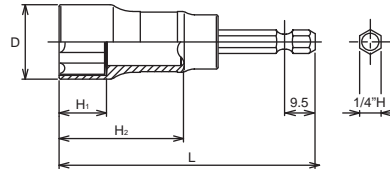

BD014E (mm)	D (mm)	H <sub>1</sub> (mm)	H <sub>2</sub> (mm)	L (mm)	(g)	(pcs.)
17SF	23.5	18	60	104	94	10
19SF	25.5	18	60	104	100	10
21SF	28	18	60	104	110	10

◆ DIN 3126 Form E 6.3



### BD014E-SF

Surface Drive Nut Setters, deep  
Surface Drive Steckschlüsselklingen, lang  
Douilles longues, Surface Drive

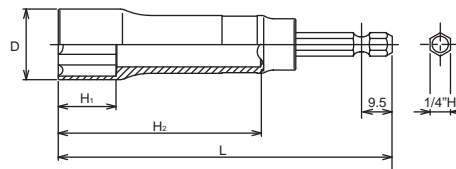

BD008E-165 (mm)	D (mm)	H <sub>1</sub> (mm)	H <sub>2</sub> (mm)	L (mm)	(g)	(pcs.)
17	22.5	17	110	165	105	10
19	24.5	17	110	165	135	10
21	27	17	110	165	142	10

◆ DIN 3126 Form E 6.3

### BD008E-165

12-point Nut Setter, extra long  
12-kant Steckschlüsselklinge, extra lang  
Douilles 12-pans à embout, extra longues

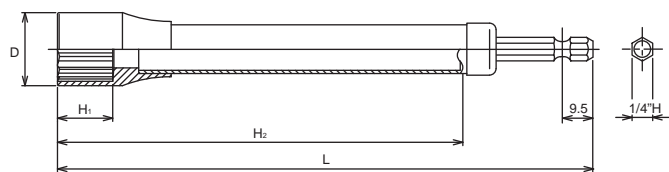

BD011SE (mm)	D (mm)	H <sub>1</sub> (mm)	H <sub>2</sub> (mm)	L (mm)	(g)	(pcs.)
10	14	12	35	100	73	10
12	16.5	12	35	100	77	10
13	17.5	12	35	100	79	10
14	19	12	32	100	82	10
17	22.5	14	32	100	87	10
19	24.5	14	30	100	94	10
21	27	14	30	100	103	10
22	28	14	30	100	104	10

◆ DIN 3126 Form E 6.3

### BD011SE



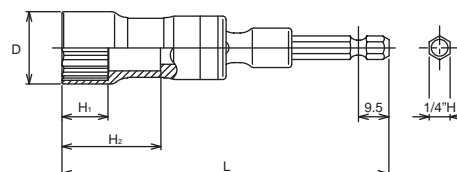

12-point Universal Joint Nut Setters  
12-kant Steckschlüsselklingen mit Gelenk  
Douilles 12-pans articulées à embout

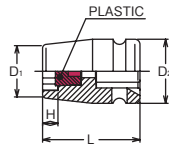

Z-SERIES  
 HAND  
 TITANIUM  
 SCREWDRIVERS ACCESSORIES  
 IMPACT  
 SLEEVE-DRIVE  
 PROTECTOR  
 INDUSTRIAL  
 AUTOMOTIVE  
 MOTORCYCLE  
 CONSTRUCTION  
 SPARE PART

**BD14400MJ**  6-point Sockets for Anchor Screws  
 6-kant Steckschlüssel  
 Douilles 6-pans





BD14400MJ (mm)		D <sub>1</sub> (mm)	D <sub>2</sub> (mm)	H (mm)	L (mm)	 (g)	 (pcs.)	
13	1/2"	20.7	25	5	38	140	10	*1
15		23.2	30	5	38	145	10	*2
16		24.5	30	6.5	38	145	10	*2
17		25.7	30	6.5	38	145	10	*2
19		28.2	30	7.5	38	145	10	*2
21		30.7	30	9	38	185	10	*2
24	34.5	30	10.5	38	190	10	*2	

\*1 C-Ring=1401C, Pin/O-Ring=1401A/B  
 \*2 C-Ring=1402C, Pin/O-Ring=1402A/B  P254-255

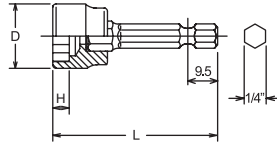
**BD016E**  6-point Sockets for Anchor Screws  
 6-kant Steckschlüssel  
 Douilles 6-pans





BD016E (mm)	D (mm)	H (mm)	L (mm)	 (g)	 (pcs.)
13	19.5	4	50	43	10
17	24.5	5	50	56	10
19	27	6	50	68	10

● DIN 3126 Form E 6.3

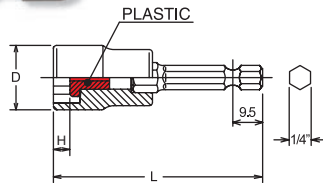
**BD016JE**  6-point Nut Setters with Plastic Stops  
 6-kant Steckschlüsselklingen mit Plastik-Anschlag  
 Douilles 6-pans à embout avec arrêt en plastique



BD016JE (mm)	D (mm)	H (mm)	L (mm)	 (g)	 (pcs.)
13	19.5	5	60	66	10
17	24.5	6.5	60	80	10
19	27	7.5	60	90	10

● DIN 3126 Form E 6.3

**BD017E** Wing Bolt Socket for Electric Drill  
 6-kant Steckschlüsselklingen für Flügelschrauben  
 Douilles 6-pans à embout pour ecrous à oreilles

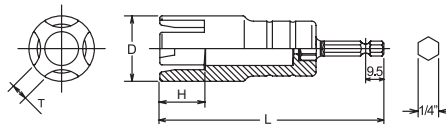

BD017E	D (mm)	T (mm)	H (mm)	L (mm)	 (g)	 (pcs.)
	31	7.3	21	104	158	10

● DIN 3126 Form E 6.3



BD018		D (mm)	T (mm)	H (mm)	L (mm)	(g)	(pcs.)	
	$\frac{3}{8}$ "	31	7.3	21	45	113	10	+2

\*2 C-Ring=1302C, Pin/O-Ring=1401A/B → P254-255

**BD018** Wing Bolt Socket  
Steckschlüssel für Flügelschrauben  
Douilles pour écrous à oreilles

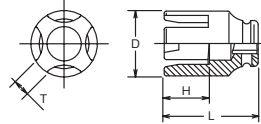

3119 (mm)		T <sub>1</sub> ×T <sub>2</sub> (mm)	D <sub>1</sub> (mm)	D <sub>2</sub> (mm)	d (mm)	L (mm)	(g)	(pcs.)
3 x5	$\frac{3}{8}$ "	3 x5	17	17.3	11	30	30	10
5.5x6		5.5x6	21	19.5	14	33	45	10



For Wing Bolt  
Für Flügelschrauben  
Pour écrous à oreilles



For Drain Plug in Radiator  
Für Kühler-Ablassschrauben  
Pour le vidange du radiateur

**3119** Wing Bolt Socket  
Steckschlüssel für Flügelschrauben  
Douilles pour écrous à oreilles

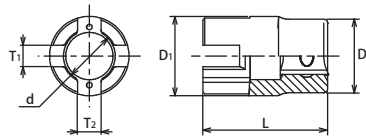

162E (mm)	D (mm)	L (mm)	(g)	(pcs.)
8	23	66	82	10
10	27.9	66	107	10

162E (inch)	D (mm)	L (mm)	(g)	(pcs.)
1/4	23	66	83	10
5/16	23	66	82	10
3/8	27.9	66	107	10
1/2	27.9	66	108	10

◆ DIN 3126 Form E 6.3

**162E** Stud Setters  
Stehbolzeneindreher  
Monte-goujons

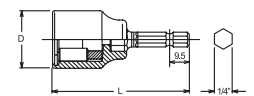
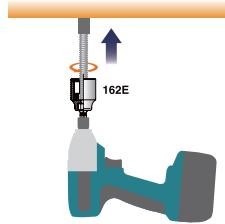

BD004 (mm)		D <sub>1</sub> (mm)	D <sub>2</sub> (mm)	L (mm)	(g)	(pcs.)
12.5x10	$\frac{1}{2}$ "	30	25	70	236	5
12.5x13		38	30	75	388	5
12.5x16		38	30	75	369	5
20 x19	$\frac{3}{4}$ "	48	44	90	775	2
20 x22		48	44	90	752	2
20 x25		62	44	95	1184	2
20 x29		62	44	95	1148	2



**BD004** Impact Screw and Stud Setters  
Impact Stehbolzeneindreher  
Monte goujons, Impact

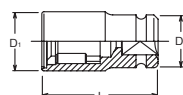

Z-SERIES  
 HAND  
 TITANIUM  
 SCREWDRIVERS ACCESSORIES  
 IMPACT  
 SLEEVE-DRIVE  
 PROTECTOR  
 INDUSTRIAL  
 AUTOMOTIVE  
 MOTORCYCLE  
 CONSTRUCTION  
 SPARE PART

**HA001** Stud Setters  
 Stehbolzeneindreher  
 Monte-goujons

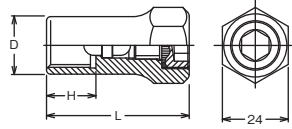

HA001	D (mm)	H (mm)	L (mm)	(g)	(pcs.)
10(1.5)	15.5	13	47	90	10
12(1.25)	17.2	15	49	100	10
16(2.0)	21	18	52	125	10
20(2.5)	24.5	21	56	155	10
22(2.5)	26.5	27	61	175	10
24(3.0)	28	28	62	185	10

**HA003** Drive Part  
 Antriebsteil  
 Propulseur

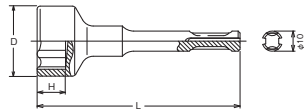
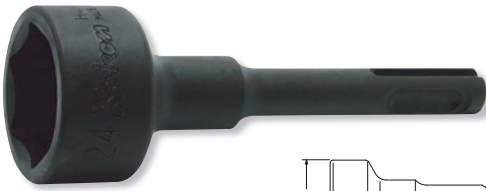

HA003 (mm)	D (mm)	H (mm)	L (mm)	(g)	(pcs.)
24	34.5	14	100	155	10

Socket for HA001



**BD022-120P** Hammer Drill Adaptor  
 Adapter für Schlagbohrmaschinen  
 Adaptateur pour aléseuses

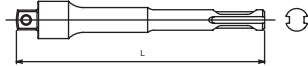

BD022-120P		L (mm)	(g)	(pcs.)
3/8	3/8"	120	100	10
1/2	1/2"	120	160	10

**BD023E** Adaptors  
 Verbindungsstücke  
 Adaptateurs

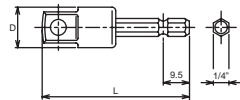

BD023E		D (mm)	L (mm)	(g)	(pcs.)
3/8	3/8"	12.5	55	27	10
1/2	1/2"	16.5	60	48	10

● DIN 3126 Form E 6.3

**BD024E** Universal Adaptors  
 Gelenk Adapter  
 Augmentator articulé

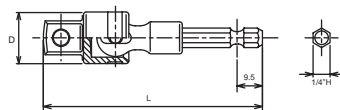

BD024E		D (mm)	L (mm)	(g)	(pcs.)
3/8	3/8"	19.3	78	63	10
1/2	1/2"	19.3	82	73	10

● DIN 3126 Form E 6.3

170S (mm)	D (mm)	T (mm)	L (mm)	(g)	(pce.)
10x12	34	38	250	260	1
12x14	34	38	250	260	1

171S (mm)	D (mm)	T (mm)	L (mm)	(g)	(pce.)
14x17	44.6	50	250	460	1
17x19	44.6	50	250	460	1
17x21	44.6	50	250	460	1
19x21	44.6	50	250	460	1

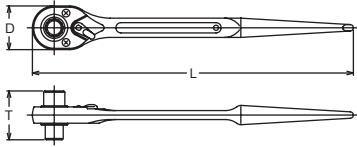

**170S** ○ Spud Handle Ratchets, reversible  
Doppelseitige Gerüstbauknarre, umstellbar  
Cliquets, réversibles, pour assemblage et démontage -  
échafaudages, manche pointu



**171S** ○ Spud Handle Ratchets, reversible  
Doppelseitige Gerüstbauknarre, umstellbar  
Cliquets, réversibles, pour assemblage et démontage -  
échafaudages, manche pointu



**171** ○ Spud Handle Ratchets (Long), reversible  
Doppelseitige Gerüstbauknarre, lange Ausführung, umstellbar  
Cliquets longs, réversibles, pour assemblage et démontage -  
échafaudages, manche pointu

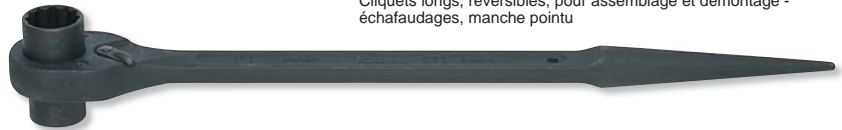

171 (mm)	D (mm)	T (mm)	L (mm)	(g)	(pce.)
14x17	44.6	50	380	630	1
17x19	44.6	50	380	630	1
17x21	44.6	50	380	630	1
19x21	44.6	50	380	630	1

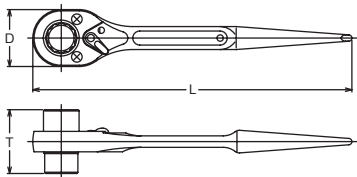

**172** ○ Spud Handle Ratchets (Long), reversible  
Doppelseitige Gerüstbauknarre, lange Ausführung, umstellbar  
Cliquets longs, réversibles, pour assemblage et démontage -  
échafaudages, manche pointu



172 (mm)	D (mm)	T (mm)	L (mm)	(g)	(pce.)
21x26	68	58	380	1100	1
22x24	68	58	380	1100	1
23x26	68	58	380	1100	1
24x27	68	58	380	1100	1
26x32	68	63	380	1100	1

171SB-1/2	(mm)	D (mm)	T (mm)	L (mm)	(g)	(pce.)
1/2"	44.6	33	250	480	1	

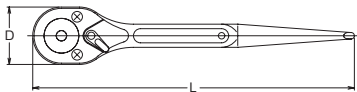

**171SB-1/2** Spud Handle Ratchet with Push Button (short)



171B-1/2	(mm)	D (mm)	T (mm)	L (mm)	(g)	(pce.)
1/2"	44.6	33	380	650	1	



**171B-1/2** Spud Handle Ratchet with Push Button (Long)

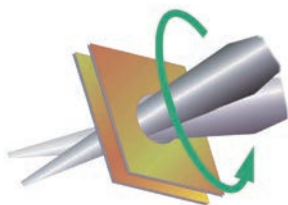

Twin Opening Spud Handle Ratchets  
The tapered handle is designed to align bolt holes in flanges, rivet holes or similar assemblies.

Knarren mit doppelseitiger Steckschlüssel-Kombination und konischem Griff für die Ausrichtung von Bohrlöchern z. B. an Flanschen und Gerüsten.

Cliquets à tête double avec manche conique pour aligner les trous des boulons lors des travaux d'échafaudage ou de tout travail de construction.



Ko-ken welcomes customer's enquiries for special tools.  
New items can be designed and manufactured according to customers  
requirements. Please enquire through your distributors.

Wir nehmen auch gerne Ihre Anfrage für Sonderartikel entgegen.  
Sonderartikel fertigen wir nach Ihren Anweisungen.  
Richten Sie Ihre Anfragen bitte an Ihren örtlichen Händler.

Nous étudierons volontier toute demande d'outils spéciaux.  
Nous pouvons concevoir et fabriquer tout outil selon vos spécifications.  
Veuillez contacter votre distributeur habituel.



**SPARE PART SETS  
ERSATZTEILSÄTZE  
PIÈCES DE RECHANGE**



Spare Part Sets  
Ersatzteilsätze  
Pièces de rechange

Z-SERIES  
HAND  
TITANIUM  
ACCESSORIES  
SCREWDRIVERS  
IMPACT  
SLEEVE-DRIVE  
PROTECTOR  
INDUSTRIAL  
AUTOMOTIVE  
MOTORCYCLE  
CONSTRUCTION  
SPARE PART

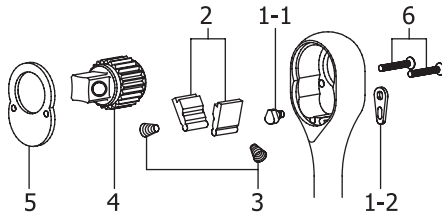
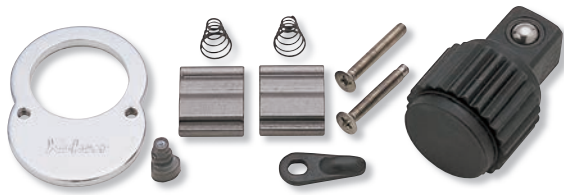

- 1-1 Reversion Cam
- 1-2 Reversion Lever
- 2 Dog
- 3 Spring
- 4 Square Drive
- 5 Cover plate
- 6 Screw

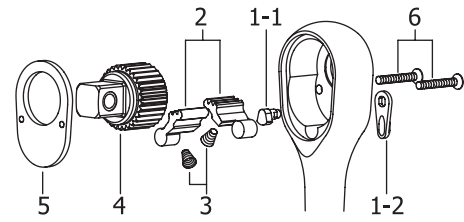

- 1-1 Reversion Cam
- 1-2 Reversion Lever
- 2 Dog
- 3 Spring
- 4 Square Drive
- 5 Cover plate
- 6 Screw

	▣	Products	(g)	(pce.)
2749RK	1/4"	2749N/P/J	30	1
2753RK		2753N/P/J, 2753PS/PSKR, 2753P-160, 2774PS/JS, 2774N/P/J	30	1
2753BRK		2753NB/PB/JB	31	1
2749RK-3/8	3/8"	2749PS-3/8, 2749N-3/8, 2749P-3/8, 2774PS-3/8, 2774JS-3/8	45	1
3749RK		3749S, 3749N	70	1
3749BRK	1/2"	3749SB	84	1
3753RK		3753N/P/J, 3753SM, 3753P-250, 3774N/P/J, 2774PS, 3774NL/PL/JL	84	1
3753BRK		3753NB/PB/JB, 3753SMB, 3774NB/PB/JB/JBL	76	1
3749SRK-1/2	1/2"	3749S-1/2	120	1
3749SBRK-1/2		3749SB-1/2	120	1
4749RK	3/4"	4749N-250, 4749N-380, 4749J-380	130	1
4753RK		4753N/P/J, 4753P-410, 4774N/P/J, 4774P-450	130	1
4753BRK		4753NB/PB/JB, 4774NB/PB/JB	130	1
6749RK	1"	6749, 6749-1000	580	1
8749RK	1"	8749, 8749-1000	800	1

	▣	Products	(g)	(pce.)
4750RK	1/2"	4750N/P/J	130	1
4750BRK		4750NB/PB/JB	130	1

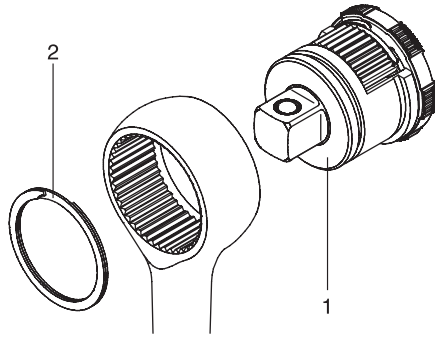

- 1 Head
- 2 Retaining Ring

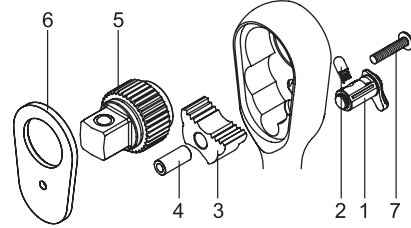

- 1 Reversion Lever
- 2 Pin+Spring
- 3 Pawl
- 4 Sleeve
- 5 Square Drive
- 6 Cover Plate
- 7 Screw

	□	Products	(g)	(pce.)
3752RK	3/8"	3752N/J, 3757, 3776N/P/J	84	1
4752RK	1/2"	4752N/J	140	1

	□	Products	(g)	(pce.)
2725RK	1/4"	2725Z, 2725Z-160, 2726Z, 2726Z-160	30	1
2725RK-3/8	3/8"	2725Z-3/8, 2725Z-3/8(L160), 2726Z-3/8, 2726Z-3/8(L160)	45	1
3725RK	3/8"	3725Z, 3725ZS, 3725Z-280, 3726Z, 3726ZS, 3726Z-280	50	1
4725RK	1/2"	4725Z	120	1

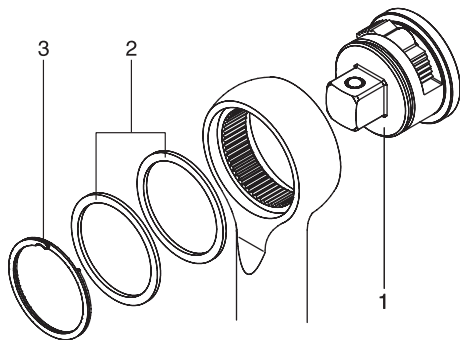

- 1 Head
- 2 Ring
- 3 Retaining Ring

	□	Products	(g)	(pce.)
6752RK	3/4"	6752	600	1



TORXPLUS® 6IP Screwdriver for 2725RK  
TORXPLUS® 8IP Screwdriver for 3725RK  
TORXPLUS® 10IP Screwdriver for 4725RK

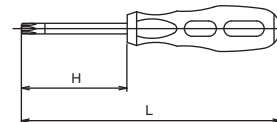

168T (IP)	H (mm)	L (mm)	(g)	(pce.)
6IP(40)	40	110	20	1
8IP(40)	40	110	20	1
10IP(40)	40	110	22	1

Spare Part Sets  
Ersatzteilsätze  
Pièces de rechange

SPARE PART CONSTRUCTION MOTORCYCLE AUTOMOTIVE INDUSTRIAL PROTECTOR SLEEVE-DRIVE IMPACT SOREWDRIVERS ACCESSORIES TITANIUM HAND Z-SERIES

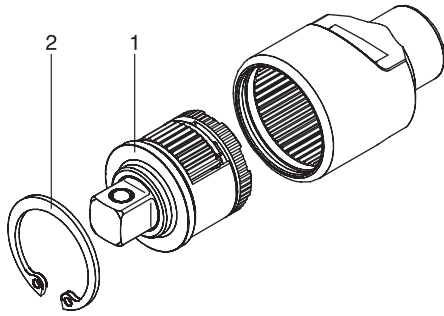

- 1 Head
- 2 Retaining Ring

	□	Products	(g)	(pce.)
2755RK	1/4"	2755	40	1
3755RK	3/8"	3755	98	1
4755RK	1/2"	4755	137	1
6755RK	3/4"	6755	550	1

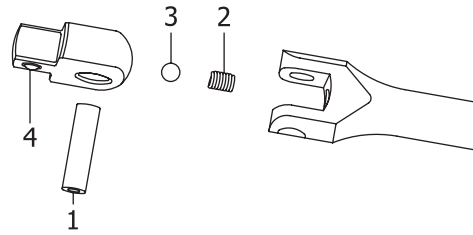

- 1 Pin
- 2 Coil Spring
- 3 Ball
- 4 Square Drive

	□	Products	(g)	(pce.)
2768RK	1/4"	2768N/P/J	40	1
6768RK	3/4"	6768, 6768-600, 6768-1000	98	1
8768RK	1"	8768, 8768-1000	137	1

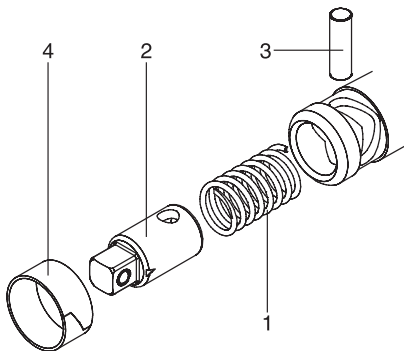

- 1 Spring
- 2 Square Drive
- 3 Pin
- 4 Retaining Ring

	□	Products	(g)	(pce.)
3112RK	3/8"	3112N/J	106	1
4112RK	1/2"	4112N/J	116	1
6112RK	3/4"	6112	445	1

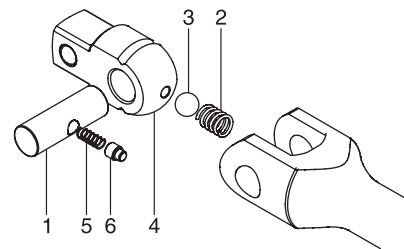

- 1 Pin
- 2 Coil Spring
- 3 Ball
- 4 Square Drive
- 5 Coil Spring
- 6 Plunger



	□	Products	(g)	(pce.)
3768RK	3/8"	3768N-175/250/300, 3768P-250/380, 3768J-250	40	1
3768ZRK	3/8"	3768Z-250/400	40	1
4768RK	1/2"	4768N-300/380/450/600, 4768N-380/ 450/600, 4768J-380/450/600, 4781N-450	137	1
4768ZRK	1/2"	4768Z-430	137	1

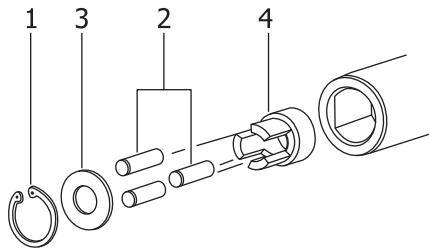
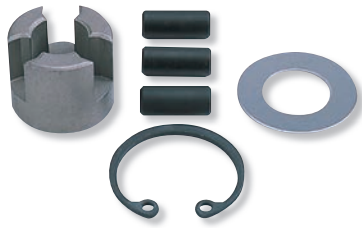

- 1 Retaining Ring
- 2 Roller
- 3 Cover
- 4 Cage

4100MRK (mm)	□	Products	(pce.)
6	1/2"	4100M-6	1
7		4100M-7	1
8		4100M-8	1
9		4100M-9	1
10		4100M-10	1
10.5		4100M-10.5	1
11		4100M-11	1
12		4100M-12	1
14		4100M-14	1
16		4100M-16	1

4100ARK (inch)	□	Products	(pce.)
1/4	1/2"	4100A-1/4	1
5/16		4100A-5/16	1
3/8		4100A-3/8	1
7/16		4100A-7/16	1
1/2		4100A-1/2	1
9/16		4100A-9/16	1
5/8		4100A-5/8	1

6100MRK (mm)	□	Products	(pce.)
18	3/4"	6100M-18	1
20		6100M-20	1
22		6100M-22	1
24		6100M-24	1
27		6100M-27	1
28		6100M-28	1
29		6100M-29	1
30		6100M-30	1

162RK	Products	(pce.)
5/16	162E-5/16	1
3/8	162E-3/8	1
1/2	162E-1/2	1
10	162E-10	1

HAND SOCKETS/ Diameter of Bore  
 HAND STECKSCHLÜSSEL/ Bohrungsdurchmesser  
 DOUILLES A MAIN/ Diamètre d'ouverture

Standard Socket



Deep Socket

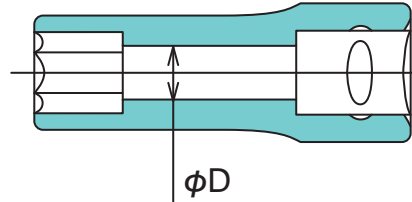
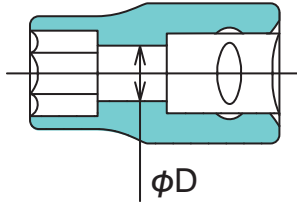

SOCKET		1/4" $\text{O}$		3/8" $\text{O}$		1/2" $\text{O}$		3/4" $\text{O}$		1" $\text{O}$
		Standard	Deep	Standard	Deep	Standard	Deep	Standard	Deep	Standard
		2400M 2400A	2300M 2300A	3400M 3400A	3300M 3300A	4400M 4400A	4300M 4300A	6400M 6400A	6300M 6300A	8400M 8400A
		2405M 2405A	2305M 2305A	3405M 3405A	3305M 3305A	4405M 4405A	4305M 4305A	6405M 6405A	6305M 6305A	8405M 8405A
(mm)	(inch)	$\phi D$								
3	1/8	2.5	2.5							
4		3	3							
4.5		3.5	3.5							
5	3/16	4	4							
5.5	7/32	4.5	4.5	4.5	4.5					
6	1/4	4.5	5	5	5					
7	9/32	6.2	6	5.5	6					
8	5/16	6.2	7	6	7	6	7			
9	11/32	8.3	8.3	7	8	7	8			
10	3/8	9.4	9	8	9	8	9			
11	7/16	10	10	9	10	9	10			
12		10	11	10	11	10	11			
13	1/2	11.5	12	11	12	11	12			
14	9/16	13	13	13.5	13.5	12	13			
15	19/32			13	14	13	14			
16	5/8			14	15	14	15			
17	21/32			15	16	15	16	15	16	
18	11/16			15	17	15	17	15	17	
19	3/4			16	18	18	18	16	18	
20	25/32			17	19	18	19	17	19	
21	13/16			18	20	18	20	18	20	
22	7/8			19	21	19	21	19	21	
23				20	22	20	22	20	22	
24	15/16			21	23	21	23	21	23	
25				22	24	22	24	22	24	
26	1			23	25	23	25	23	25	
27	1- 1/16				26	23	26	23	26	23
28						24	27	24	27	24
29	1- 1/8					24	28	24	28	24
30	1- 3/16					25	29	25	29	25
31						26	30	26	30	26
32	1- 1/4					27	31	27	31	27
33	1- 5/16					28	32	28	32	28
34						29	33	29	33	29
35	1- 3/8					30	34	30	34	30
36						31	35	31	35	31
37	1- 7/16					31	36	31	36	31
38	1- 1/2					32	37	32	37	32
39								32	38	32
40	1- 9/16							33	39	33
41	1- 5/8							34	40	34
42								34	41	34
43	1-11/16							35	42	35
44	1- 3/4							36	43	36
45								36	44	36
46	1-13/16							37	45	37
47								38	46	38
48	1- 7/8							38	47	38
	1-15/16							39	48	39
50	2							40	49	40
	2- 1/16							40		

IMPACT SOCKETS/ Diameter of Bore  
 IMPACT STECKSCHLÜSSEL/ Bohrungsdurchmesser  
 DOUILLES IMPACT / Diamètre d'ouverture

Standard Socket

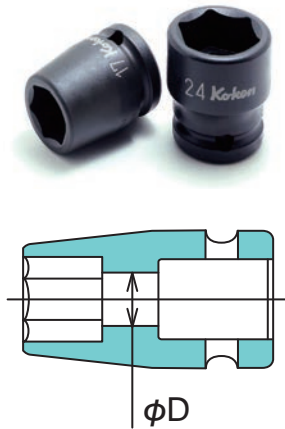

Deep Socket

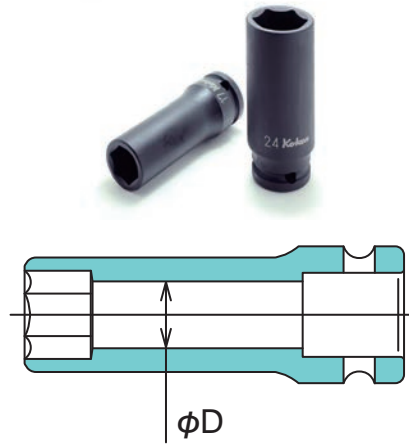

SOCKET		1/4" $\text{\textcircled{O}}$		3/8" $\text{\textcircled{O}}$		1/2" $\text{\textcircled{O}}$		3/4" $\text{\textcircled{O}}$		1" $\text{\textcircled{O}}$	
		Standard	Standard	Deep	Standard	Deep	Standard	Deep	Standard	Deep	
$\text{\textcircled{O}}$		12400M 12400A	13400M 13400A	13300M 13300A	14400M 14400A	14300M 14300A	16400M 16400A	16300M 16300A	18400M 18400A	18300M 18300A	
(mm)	(inch)	$\phi D$									
4		3									
4.5	3/16	3									
5		4									
5.5		4									
6	1/4	5	5	5							
7	9/32	5	5	6							
8	5/16	6	6	7	6	7					
9	11/32	7	7	8	7	8					
10	3/8	8	8	9	8	9					
11	7/16	9	9	10	9	10					
12		10	10	11	10	11					
13	1/2	11	11	12	11	12					
14	9/16	12	12	13	12	13					
15			13	14	13	14					
16	5/8		14	15	14	15	14	15			
17	11/16		14	16	14	16	14	16			
18			15	17	15	17	15	17			
19	3/4		16	18	16	18	16	18	16	18	
20			17	19	17	19	17	19	17	19	
21	13/16		18	20	18	20	18	20	18	20	
22	7/8		19	21	19	21	19	21	19	21	
23			20		20	22	20	22	20	22	
24	15/16		20		21	23	21	23	21	23	
25	1				22	24	22	24	22	24	
26					23	25	23	25	23	25	
27	1- 1/16				23	26	23	26	23	26	
28					23	27	24	27	24	27	
29	1- 1/8				23	28	25	28	25	28	
30	1- 3/16				23	29	26	29	26	29	
31					23	30	27	30	27	30	
32	1- 1/4				23	31	28	31	28	31	
33					25	32	29	32	29	32	
34	1- 5/16				25	33	30	33	30	33	
35	1- 3/8				25	34	31	34	31	34	
36					28	35	32	35	32	35	
37	1- 7/16						32	36	32	36	
38	1- 1/2						34	37	34	37	
40	1- 9/16						34	39	34	39	
41	1- 5/8						35	40	35	40	
42	1-11/16						35	41	35	41	
45	1- 3/4						35	44	35	44	
46	1-13/16						40	45	40	45	
47							40	46			
	1- 7/8						40	47			







Screw dimension	Hexagon Head Bolt			Hexagon Socket Head Cap Screws			TORX		TORXPLUS		Triple Square	LHSTIX	Ref.) Standard Tightning Torque (Nm)				
	Standard	Compact	High Strength	Standard	Button Head / Shoulder Head	Hexagon Socket Set Screws	T	E	IP	EP [EPL]	XZN	LH-S [LH-SS]	Grade 4.6	Grade 6.8	Grade 8.8	Grade 10.9	Grade 12.9
M2	4			1.5		0.9	T6/T8		6IP				0.12	0.24	0.32	0.45	0.54
M2.5	5			2		1.3	T8		8IP		M3		0.25	0.49	0.65	0.92	1.1
M3	5.5			2.5	2	1.5	T10	E4	8IP/10IP	4EP	M3		0.43	0.87	1.16	1.63	1.96
M3.5	(6)						T15		10IP/15IP				0.68	1.37	1.82	2.56	3.08
M4	7			3	2.5	2	T20/T25	E5	15IP/20IP	5EP	M4	LH4S	1.01	2.02	2.7	3.79	4.54
M5	8			4	3	2.5	T25/T27	E6	20IP/25IP /27IP	6EP [8EPL]	M5	LH5S	2.04	4.09	5.47	7.67	9.18
M6	10			5	4	3	T30	E8	27IP/30IP	8EP [10EPL]	M6	LH6S	3.47	6.97	9.27	13	15.6
M7	11						T40	E8	40IP	8EP [12EPL]			5.85	11.6	15.5	21.8	26.2
M8	13	(12)		6	5	4	T40/T45	E10	40IP/45IP	10EP [14EPL]	M8	LH8S	8.41	16.9	22.5	31.6	37.9
M10	16 (17)	(14)		8	6	5	T50	E12	45IP/50IP	12EP [16EPL]	M10	LH10S [LH8SS]	16.7	33.4	44.5	62.6	75.2
M12	18 (19)	(17)	21 (22)	10	8	6	T55	E14	55IP	14EP [20EPL]	M12	LH12S [LH10SS]	29.1	58.3	77.6	109	131
M14	21 (22)	(19)		12			T55/T60	E14/E18	55IP/60IP	18EP [24EPL]	M14	LH14S [LH12SS]	46.4	92.7	124	174	209
M16	24	(22)	27	14	10	8	T60/T70	E16/E20	60IP/70IP	20EP [26EPL]	M16	LH16S [LH14SS]	72.3	145	194	271	325
M18	27	(24)		(14)			T70/T80	E24	80IP	24EP [30EPL]	M18		100	199	266	373	447
M20	30 (32)	(27/29)	32	17	12	10	T80/T90	E24	90IP	24EP [32EPL]			141	282	376	529	635
M22	34 (32/35)	(30/32)	36	(17)			T90/T100	E28	100IP	24EP [36EPL]			192	384	511	720	865
M24	36 (38)	(32/35)	41	19		12	T100	E32	100IP	32EP [40EPL]			244	488	650	915	1100
M27	41	(36)	46	(19)				E32		32EP			358	713	951	1340	1610
M30	46	(41)	50	22				E36		36EP			484	971	1290	1820	2180
M33	50	(46)		(24)				E40		40EP			661	1320	1760	2470	2970
M36	55 (54)	(50)		27				E44		44EP			848	1690	2260	3180	3810
M39	60 (58)	(55)		(27)									1100	2190	2920	4110	4930
M42	65 (63)			32									1350	2710	3610	5080	6080
M45	70 (67)			(32)									1700	3400	4540	6370	7630
M48	75 (71)			36									2030	4060	5440	7620	9120
M52	80 (77)			(36)									2640	5290	7040	9880	11800
M56	85			41									3270	6560	8710	12300	14800
M60	90												4080	8180	10900	15300	18300
M64	95			46									4930	9890	13100	18500	22300
M68	(100)												5970	12000	16000	22500	27000

\*Reference: Hexagon Head Bolt: ISO 4014-4018, 8676, 8768  
 High Strength Hexagon Bolt: JIS B 1196  
 Hexagon Socket Head Cap Screws: ISO 7380  
 Hexagon Socket Button Head Screws: ISO 7380  
 Hexagon Socket Set Screws: ISO 4026-4029  
 TORX T/E: TORX Standard TMH series  
 TORXPLUS IP/EP: TORXPLUS Standard CMH series  
 Triple Square: DIN 2324/2325  
 LHSTIX LH-S/SS: LH-S/SS Standard

\* Standard Tightening Torque: Calculated based on Torque Coefficient (K): 0.2  
 Axial Force (Ff) : 60% of Proof Strength(σ)

**TORX** is a registered trademark of Acument Intellectual Properties, LLC.  
**TORX** ist ein registriertes Markenzeichen der Firma Acument Intellectual Properties, LLC.  
**TORX** est une marque déposée de Acument Intellectual Properties, LLC.

**TORXplus** is a registered trademark of Acument Intellectual Properties, LLC.  
**TORXplus** ist ein registriertes Markenzeichen der Firma Acument Intellectual Properties, LLC.  
**TORXplus** est une marque déposée de Acument Intellectual Properties, LLC.

**LHSTIX** is a registered trademark of OSG CORPORATION System Engineering Department.  
**LHSTIX** ist ein registriertes Markenzeichen der Firma OSG CORPORATION System Engineering Department.  
**LHSTIX** est une marque déposée de OSG CORPORATION System Engineering Department.

**TORX® / TORXplus® BITS**

		S1 (mm)	S2 (mm)
T6	6IP	1.7	1.2
T7	7IP	2.0	1.4
T8	8IP	2.3	1.7
T9	9IP	2.5	1.8
T10	10IP	2.7	2.0
T15	15IP	3.3	2.3
T20	20IP	3.9	2.8
T25	25IP	4.5	3.2
T27	27IP	5.0	3.6
T30	30IP	5.6	4.0
T40	40IP	6.7	4.8
T45	45IP	7.9	5.6
T50	50IP	8.9	6.2
T55	55IP	11.3	8.0
T60	60IP	13.3	9.5
T70	70IP	15.6	11.1
T80	80IP	17.6	12.7
T90	90IP	20.0	14.2
T100	100IP	22.2	15.8

**TORX® / TORXplus® SOCKETS**

		S1 (mm)	S2 (mm)
E4	4EP	3.7	2.7
E5	5EP	4.6	3.3
E6	6EP	5.6	4.0
E7	7EP	6.1	4.3
E8	8EP	7.4	5.3
E10	10EP	9.3	6.8
E11	11EP	9.9	7.1
E12	12EP	11.0	7.9
E14	14EP	12.8	9.2
E16	16EP	14.6	10.5
E18	18EP	16.5	11.9
E20	20EP	18.3	13.2
E22	22EP	20.1	14.8
E24	24EP	22.0	15.7
E26	26EP	23.7	17.5
E28	28EP	25.5	18.3
E30	30EP	27.3	20.0
E32	32EP	29.0	21.3

**TORXplus® BITS**

		S1 (mm)	S2 (mm)
8IPR		2.2	2.0
9IPR		2.4	2.2
10IPR		2.6	2.4
15IPR		3.1	2.8
20IPR		3.6	3.3
25IPR		4.1	3.8
27IPR		4.7	4.3
30IPR		5.2	4.8
40IPR		6.3	5.7
45IPR		7.4	6.7
50IPR		8.4	7.6
55IPR		10.6	9.7

**LHSTIX® (LH-S) SOCKETS**

		S1 (mm)	S2 (mm)
LH3S		3.8	4.7
LH4S		4.5	6.0
LH5S		5.6	7.5
LH6S		6.8	9.0
LH7S		7.9	10.5
LH8S		9.0	12.0
LH10S		11.3	15.0
LH12S		13.6	18.0
LH14S		15.8	21.0
LH16S		18.1	24.0

**XZN BITS**

		S1 (mm)	S2 (mm)
M4		3.6	3.1
M5		4.8	4.1
M6		6.1	5.1
M8		7.3	6.1
M10		9.7	8.1
M12		11.5	9.7
M14		13.3	11.2
M16		15.7	13.2
M18		16.9	14.2

**Ribe CV BITS**

		W (mm)	S1 (mm)	S2 (mm)
M5		1.2	5.0	3.8
M6		1.3	6.0	4.5
M7		1.4	7.0	5.0
M8		1.8	8.0	6.0
M9		2.0	9.0	7.1
M10		2.3	10.0	7.4
M12		2.6	12.0	9.0
M13		3.1	13.0	11.0
M14		3.2	14.0	10.4
M16		3.6	16.0	11.9

TORX® is a registered trademark of Acument Intellectual Properties, LLC.  
 TORX® ist ein registriertes Markenzeichen der Firma Acument Intellectual Properties, LLC.  
 TORX® est une marque déposée de Acument Intellectual Properties, LLC.

TORXplus® is a registered trademark of Acument Intellectual Properties, LLC.  
 TORXplus® ist ein registriertes Markenzeichen der Firma Acument Intellectual Properties, LLC.  
 TORXplus® est une marque déposée de Acument Intellectual Properties, LLC.

LHSTIX® is a registered trademark of OSG CORPORATION System Engineering Department.  
 LHSTIX® ist ein registriertes Markenzeichen der Firma OSG CORPORATION System Engineering Department.  
 LHSTIX® est une marque déposée de OSG CORPORATION System Engineering Department.



### Conversion Table: American Inches-Decimal Inches-Millimeter

in	dec.in.	Millimeter(mm)											
		0"	1"	2"	3"	4"	5"	6"	7"	8"	9"	10"	11"
1/64	0	0	25.4000	50.8000	76.2000	101.6000	127.0000	152.4000	177.8000	203.2000	228.6000	254.0000	279.4000
1/32	0.01563	0.3969	25.7969	51.1969	76.5969	101.9969	127.3969	152.7969	178.1969	203.5969	228.9969	254.3969	279.7969
3/64	0.04688	1.1906	26.5906	51.9906	77.3906	102.7906	128.1906	153.5906	178.9906	204.3906	229.7906	255.1906	280.5906
1/16	0.06250	1.5875	26.9875	52.3875	77.7875	103.1875	128.5875	153.9875	179.3875	204.7875	230.1875	255.5875	280.9875
5/64	0.07813	1.9844	27.3844	52.7844	78.1844	103.5844	128.9844	154.3844	179.7844	205.1844	230.5844	255.9844	281.3844
3/32	0.09375	2.3813	27.7813	53.1813	78.5813	103.9813	129.3813	154.7813	180.1813	205.5813	230.9813	256.3813	281.7813
7/64	0.10938	2.7781	28.1781	53.5781	78.9781	104.3781	129.7781	155.1781	180.5781	205.9781	231.3781	256.7813	282.1781
1/8	0.12500	3.1750	28.5750	53.9750	79.3750	104.7750	130.1750	155.5750	180.9750	206.3750	231.7750	257.1750	282.5750
9/64	0.14063	3.5719	28.9719	54.3719	79.7719	105.1719	130.5719	155.9719	181.3719	206.7719	232.1719	257.5719	282.9719
5/32	0.15625	3.9688	29.3688	54.7688	80.1688	105.5688	130.9688	156.3688	181.7688	207.1688	232.5688	257.9688	283.3688
11/64	0.17188	4.3656	29.7656	55.1656	80.5656	105.9656	131.3656	156.7656	182.1656	207.5656	232.9656	258.3656	283.7656
3/16	0.18750	4.7625	30.1625	55.5625	80.9625	106.3625	131.7625	157.1625	182.5625	207.9625	233.3625	258.7625	284.1625
13/64	0.20313	5.1594	30.5594	55.9594	81.3594	106.7594	132.1594	157.5594	182.9594	208.3594	233.7594	259.1594	284.5594
7/32	0.21875	5.5563	30.9563	56.3563	81.7563	107.1563	132.5563	157.9563	183.3563	208.7563	234.1563	259.5563	284.9563
15/64	0.23438	5.9531	31.3531	56.7531	82.1531	107.5531	132.9531	158.3531	183.7531	209.1531	234.5531	259.9531	285.3531
1/4	0.25000	6.3500	31.7500	57.1500	82.5500	107.9500	133.3500	158.7500	184.1500	209.5500	234.9500	260.3500	285.7500
17/64	0.26563	6.7469	32.1469	57.5469	82.9469	108.3469	133.7469	159.1469	184.5469	209.9469	235.3469	260.7469	286.1469
9/32	0.28125	7.1438	32.5438	57.9438	83.3438	108.7438	134.1438	159.5438	184.9438	210.3438	235.7438	261.1438	286.5438
19/64	0.29688	7.5406	32.9406	58.3406	83.7406	109.1406	134.5406	159.9406	185.3406	210.7406	236.1406	261.5406	286.9406
5/16	0.31250	7.9375	33.3375	58.7375	84.1375	109.5375	134.9375	160.3375	185.7375	211.1375	236.5375	261.9375	287.3375
21/64	0.32813	8.3344	33.7344	59.1344	84.5344	109.9344	135.3344	160.7344	186.1344	211.5344	236.9344	262.3344	287.7344
11/32	0.34375	8.7313	34.1313	59.5313	84.9313	110.3313	135.7313	161.1313	186.5313	211.9313	237.3313	262.7313	288.1313
23/64	0.35938	9.1281	34.5281	59.9281	85.3281	110.7281	136.1281	161.5281	186.9281	212.3281	237.7281	263.1281	288.5281
3/8	0.37500	9.5250	34.9250	60.3250	85.7250	111.1250	136.5250	161.9250	187.3250	212.7250	238.1250	263.5250	288.9250
25/64	0.39063	9.9219	35.3219	60.7219	86.1219	111.5219	136.9219	162.3219	187.7219	213.1219	238.5219	263.9219	289.3219
13/32	0.40625	10.3188	35.7188	61.1188	86.5188	111.9188	137.3188	162.7188	188.1188	213.5188	238.9188	264.3188	289.7188
27/64	0.42188	10.7156	36.1156	61.5156	86.9156	112.3156	137.7156	163.1156	188.5156	213.9156	239.3156	264.7156	290.1156
7/16	0.43750	11.1125	36.5125	61.9125	87.3125	112.7125	138.1125	163.5125	188.9125	214.3125	239.7125	265.1125	290.5125
29/64	0.45313	11.5094	36.9094	62.3094	87.7094	113.1094	138.5094	163.9094	189.3094	214.7094	240.1094	265.5094	290.9094
15/32	0.46875	11.9063	37.3063	62.7063	88.1063	113.5063	138.9063	164.3063	189.7063	215.1063	240.5063	265.9063	291.3063
31/64	0.48438	12.3031	37.7031	63.1031	88.5031	113.9031	139.3031	164.7031	190.1031	215.5031	240.9031	266.3031	291.7031
1/2	0.50000	12.7000	38.1000	63.5000	88.9000	114.3000	139.7000	165.1000	190.5000	215.9000	241.3000	266.7000	292.1000
33/64	0.51563	13.0969	38.4969	63.8969	89.2969	114.6969	140.0969	165.4969	190.8969	216.2969	241.6969	267.0969	292.4969
17/32	0.53125	13.4938	38.8938	64.2938	89.6938	115.0938	140.4938	165.8938	191.2938	216.6938	242.0938	267.4938	292.8938
35/64	0.54688	13.8906	39.2906	64.6906	90.0906	115.4906	140.8906	166.2906	191.6906	217.0906	242.4906	267.8906	293.2906
9/16	0.56250	14.2875	39.6875	65.0875	90.4875	115.8875	141.2875	166.6875	192.0875	217.4875	242.8875	268.2875	293.6875
37/64	0.57813	14.6844	40.0844	65.4844	90.8844	116.2844	141.6844	167.0844	192.4844	217.8844	243.2844	268.6844	294.0844
19/32	0.59375	15.0813	40.4813	65.8813	91.2813	116.6813	142.0813	167.4813	192.8813	218.2813	243.6813	269.0813	294.4813
39/64	0.60938	15.4781	40.8781	66.2781	91.6781	117.0781	142.4781	167.8781	193.2781	218.6781	244.0781	269.4781	294.8781
5/8	0.62500	15.8750	41.2750	66.6750	92.0750	117.4750	142.8750	168.2750	193.6750	219.0750	244.4750	269.8750	295.2750
41/64	0.64063	16.2719	41.6719	67.0719	92.4719	117.8719	143.2719	168.6719	194.0719	219.4719	244.8719	270.2719	295.6719
21/32	0.65625	16.6688	42.0688	67.4688	92.8688	118.2688	143.6688	169.0688	194.4688	219.8688	245.2688	270.6688	296.0688
43/64	0.67188	17.0656	42.4656	67.8656	93.2656	118.6656	144.0656	169.4656	194.8656	220.2656	245.6656	271.0656	296.4656
11/16	0.68750	17.4625	42.8625	68.2625	93.6625	119.0625	144.4625	169.8625	195.2625	220.6625	246.0625	271.4625	296.8625
45/64	0.70313	17.8594	43.2594	68.6594	94.0594	119.4594	144.8594	170.2594	195.6594	221.0594	246.4594	271.8594	297.2594
23/32	0.71875	18.2563	43.6563	69.0563	94.4563	119.8563	145.2563	170.6563	196.0563	221.4563	246.8563	272.2563	297.6563
47/64	0.73438	18.6531	44.0531	69.4531	94.8531	120.2531	145.6531	171.0531	196.4531	221.8531	247.2531	272.6531	298.0531
3/4	0.75000	19.0500	44.4500	69.8500	95.2500	120.6500	146.0500	171.4500	196.8500	222.2500	247.6500	273.0500	298.4500
49/64	0.76563	19.4469	44.8469	70.2469	95.6469	121.0469	146.4469	171.8469	197.2469	222.6469	248.0469	273.4469	298.8469
25/32	0.78125	19.8438	45.2438	70.6438	96.0438	121.4438	146.8438	172.2438	197.6438	223.0438	248.4438	273.8438	299.2438
51/64	0.79688	20.2406	45.6406	71.0406	96.4406	121.8406	147.2406	172.6406	198.0406	223.4406	248.8406	274.2406	299.6406
13/16	0.81250	20.6375	46.0375	71.4375	96.8375	122.2375	147.6375	173.0375	198.4375	223.8375	249.2375	274.6375	300.0375
53/64	0.82813	21.0344	46.4344	71.8344	97.2344	122.6344	148.0344	173.4344	198.8344	224.2344	249.6344	275.0344	300.4344
27/32	0.84375	21.4313	46.8313	72.2313	97.6313	123.0313	148.4313	173.8313	199.2313	224.6313	250.0313	275.4313	300.8313
55/64	0.85938	21.8281	47.2281	72.6281	98.0281	123.4281	148.8281	174.2281	199.6281	225.0281	250.4281	275.8281	301.2281
7/8	0.87500	22.2250	47.6250	73.0250	98.4250	123.8250	149.2250	174.6250	200.0250	225.4250	250.8250	276.2250	301.6250
57/64	0.89063	22.6219	48.0219	73.4219	98.8219	124.2219	149.6219	175.0219	200.4219	225.8219	251.2219	276.6219	302.0219
29/32	0.90625	23.0188	48.4188	73.8188	99.2188	124.6188	150.0188	175.4188	200.8188	226.2188	251.6188	277.0188	302.4188
59/64	0.92188	23.4156	48.8156	74.2156	99.6156	125.0156	150.4156	175.8156	201.2156	226.6156	252.0156	277.4156	302.8156
15/16	0.93750	23.8125	49.2125	74.6125	100.0125	125.4125	150.8125	176.2125	201.6125	227.0125	252.4125	277.8125	303.2125
61/64	0.95313	24.2094	49.6094	75.0094	100.4094	125.8094	151.2094	176.6094	202.0094	227.4094	252.8094	278.2094	303.6094
31/32	0.96875	24.6063	50.0063	75.4063	100.8063	126.2063	151.6063	177.0063	202.4063	227.8063	253.2063	278.6063	304.0063
63/64	0.98438	25.0031	50.4031	75.8031	101.2031	126.6031	152.0031	177.4031	202.8031	228.2031	253.6031	279.0031	304.4031
		12"	13"	14"	15"	16"	17"	18"	19"	20"	21"	22"	23"
in.	dec.in.	Millimeter(mm)											
1/32	0	304.8000	330.2000	355.6000	381.0000	406.4000	431.8000	457.2000	482.6000	508.0000	533.4000	558.8000	584.2000
1/16	0.03125	305.5938	330.9938	356.3938	381.7938	407.1938	432.5938	457.9938	483.3938	508.7938	534.1938	559.5938	584.9938
1/8	0.06250	306.3875	331.7875	357.1875	382.5875	407.9875	433.3875	458.7875	484.1875	509.5875	534.9875	560.3875	585.7875
3/32	0.09375	307.1813	332.5813	357.9813	383.3813	408.7813	434.1813	459.5813	484.9813	510.3813	535.7813	561.1813	586.5813
1/8	0.12500	307.9750	333.3750	358.7750									

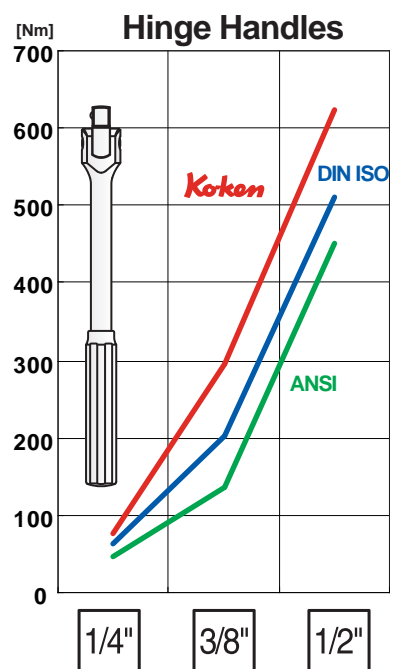
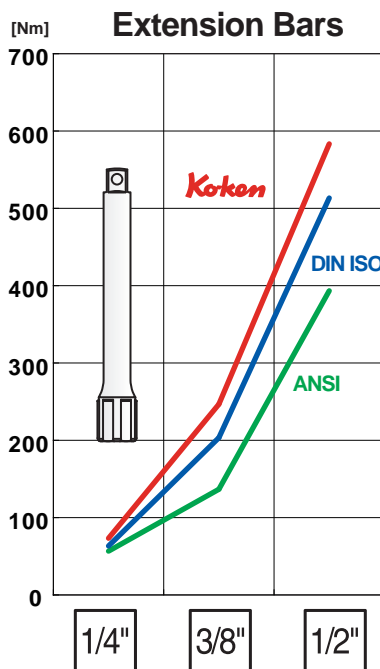
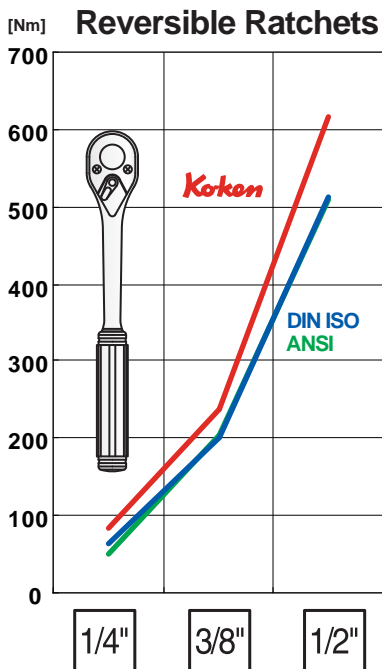
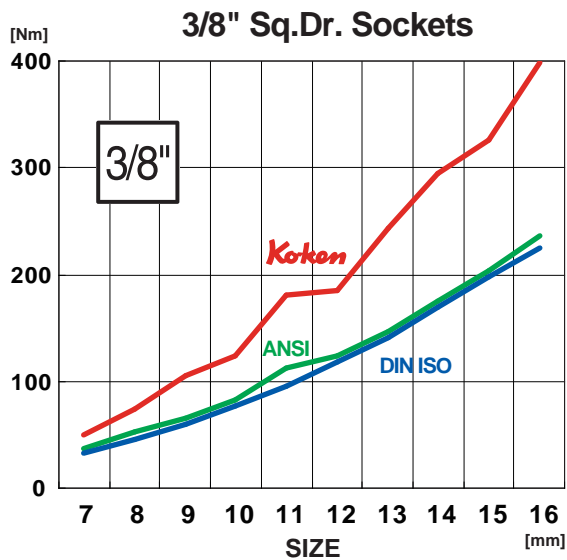
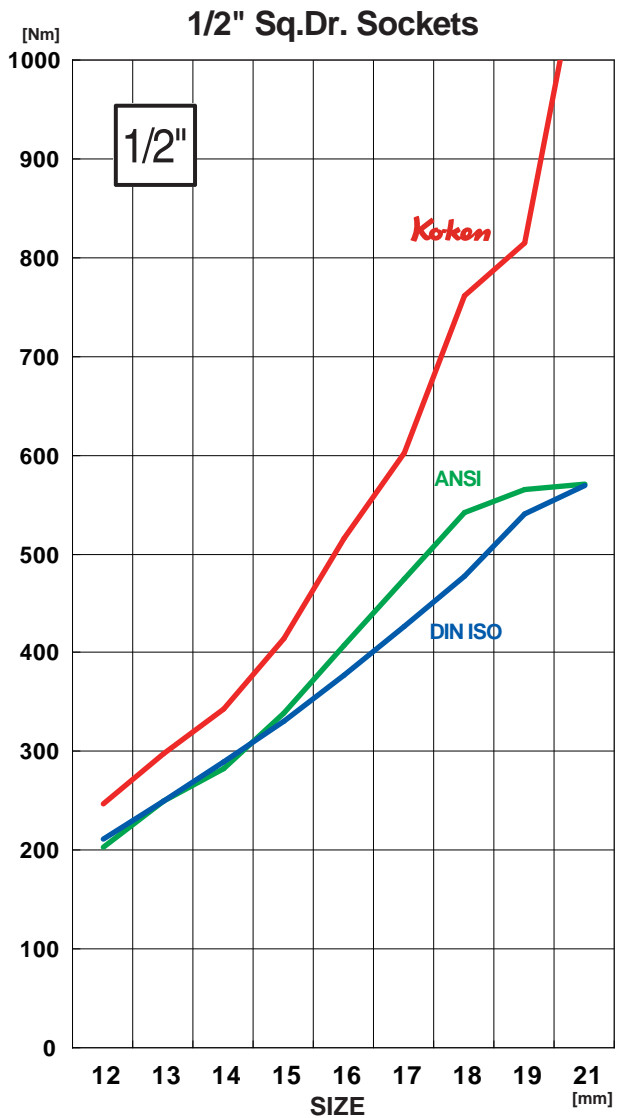
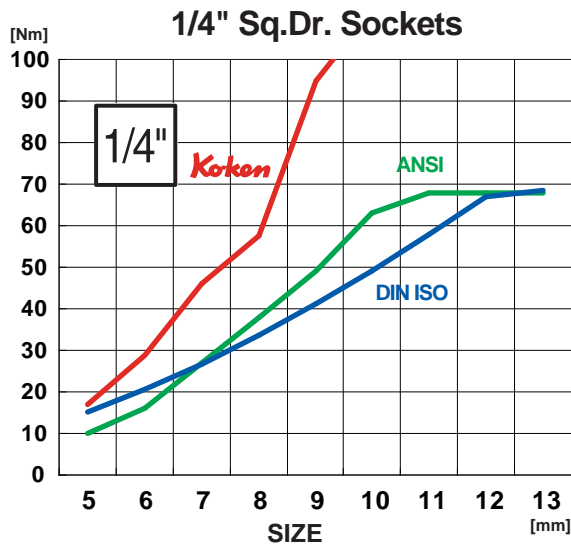

## Numerical Index

<b>10099A</b>	246	<b>12365M</b>	180	<b>13425-EPL</b>	184	<b>14325</b>	205
<b>100H</b>	158	<b>123PG</b>	162	<b>13425EG</b>	184	<b>14365M</b>	205
<b>100P</b>	158	<b>123PN</b>	162	<b>13430M</b>	189	<b>14400-WN</b>	202
<b>100P (PZ)</b>	158	<b>123PT</b>	162	<b>13440A</b>	189	<b>14400A</b>	199
<b>100S</b>	158	<b>12400A</b>	178	<b>13440M</b>	189	<b>14400M</b>	199
<b>100T (T)</b>	158	<b>12400AG</b>	178	<b>13440T</b>	189	<b>14400M-FR</b>	260
<b>100T (TH)</b>	159	<b>12400M</b>	178	<b>13460A</b>	185	<b>14400MG</b>	201
<b>100X (XZN)</b>	159	<b>12400MG</b>	178	<b>13460AG</b>	185	<b>14401A</b>	200
<b>101A</b>	147	<b>12410M</b>	178	<b>13460M</b>	185	<b>14401LH</b>	201
<b>101B</b>	146	<b>12425</b>	179	<b>13460MG</b>	185	<b>14401M</b>	200
<b>101H</b>	146	<b>12760</b>	181	<b>13465M</b>	184	<b>14401MS</b>	201
<b>101P</b>	146	<b>12460A</b>	179	<b>135E</b>	168	<b>14405A</b>	199
<b>101S</b>	146	<b>12460AG</b>	179	<b>137</b>	145	<b>14405M</b>	199
<b>101T (T)</b>	146	<b>12460M</b>	179	<b>13760</b>	197	<b>14406A</b>	200
<b>101T (TH)</b>	146	<b>12460MG</b>	179	<b>13760-P.FR</b>	259	<b>14406M</b>	200
<b>102KA</b>	142	<b>12465M</b>	179	<b>13770</b>	198	<b>14410M</b>	201
<b>102KM</b>	142	<b>124M (2B)</b>	150	<b>13771</b>	198	<b>14415M</b>	202
<b>102KM.BH</b>	142	<b>12770</b>	181	<b>13772-P</b>	198, 281	<b>14425</b>	202
<b>102KT</b>	142	<b>127C</b>	271	<b>138</b>	145	<b>14425-EPL</b>	202
<b>102NA</b>	142	<b>128H</b>	147	<b>139</b>	145	<b>14433A</b>	216
<b>102NM</b>	142	<b>128T</b>	147	<b>14012M</b>	209	<b>14440A</b>	206
<b>103KA</b>	143	<b>13012M</b>	192	<b>14025</b>	209	<b>14440M</b>	206
<b>103KA.BH</b>	143	<b>13025</b>	192	<b>141</b>	136	<b>14444AL</b>	215
<b>103KM</b>	143	<b>13103M</b>	137, 189	<b>14100A</b>	135, 206	<b>14455A</b>	216
<b>103KT</b>	143	<b>13134</b>	167, 193	<b>14100M</b>	135, 206	<b>14465M</b>	202
<b>10400A</b>	246	<b>13134M</b>	195	<b>14101M</b>	287	<b>14466A</b>	216
<b>10400M</b>	246	<b>13134T (IP)</b>	195	<b>14101MP</b>	286	<b>14466A-B</b>	290
<b>104A</b>	149	<b>13134T (T)</b>	195	<b>14101MP-M/8</b>	286	<b>14488A-B</b>	290
<b>104ME</b>	149, 293	<b>13134X (XZN)</b>	195	<b>14103M</b>	137, 206	<b>144KM</b>	273
<b>106</b>	277	<b>13137E</b>	161	<b>14106</b>	213	<b>145KM-10H</b>	143
<b>107-16</b>	213, 227, 236	<b>13139</b>	157, 196	<b>14112-P</b>	286	<b>145LH3/8F</b>	278
<b>107-16 (IP)</b>	213, 227, 236	<b>13140</b>	159, 196	<b>14113J</b>	284	<b>14760</b>	215
<b>107-16 (T)</b>	213, 227, 236	<b>13142-D6.3</b>	157, 196	<b>14113M</b>	284	<b>14760-P.FR</b>	260
<b>107-16 (XZN)</b>	213, 227, 236	<b>13142-F11.2</b>	167, 193	<b>14118M</b>	284	<b>14770</b>	216
<b>107-22</b>	228, 237	<b>13142-F6.3</b>	161, 196	<b>14124</b>	285	<b>14771</b>	216
<b>107-22 (T)</b>	228, 237	<b>13145A</b>	281	<b>14124/3</b>	285	<b>14772-P</b>	216, 281
<b>107-32</b>	242	<b>13145M</b>	190	<b>14134</b>	167, 210	<b>148KM</b>	273
<b>108A</b>	156	<b>13145M (12P)</b>	190, 275	<b>14134M</b>	212	<b>150-10H</b>	143
<b>108H</b>	156	<b>13145MG</b>	190	<b>14134T (IP)</b>	212	<b>150-14H</b>	278
<b>108P</b>	156	<b>13146M</b>	191	<b>14134T (T)</b>	212	<b>15300M</b>	219
<b>108S</b>	156	<b>13147M</b>	191	<b>14134X (XZN)</b>	212	<b>15310M</b>	219
<b>108T (T)</b>	156	<b>13241M</b>	198	<b>14137E</b>	161	<b>15400M</b>	219
<b>108T (TH)</b>	156	<b>13242M</b>	198	<b>14139</b>	157, 214	<b>15410M</b>	219
<b>110</b>	168	<b>13300A</b>	186	<b>14140</b>	159, 214	<b>154K</b>	278
<b>112</b>	168	<b>13300G</b>	188	<b>14142-D6.3</b>	157, 214	<b>154M</b>	144
<b>113</b>	163	<b>13300G-FR</b>	259	<b>14142-F11.2</b>	167, 210	<b>154ML</b>	144
<b>113 (2B)</b>	163	<b>13300M</b>	186	<b>14142-F6.3</b>	161, 214	<b>155</b>	293
<b>113 (E)</b>	163	<b>13300M-FR</b>	259	<b>14145A</b>	281	<b>15544A</b>	220
<b>113-SV</b>	261	<b>13300XG</b>	186	<b>14145M</b>	207	<b>15555AL</b>	220
<b>113UN</b>	165	<b>13301A</b>	187	<b>14145PM</b>	283	<b>15566A</b>	220
<b>115</b>	164	<b>13301M</b>	187	<b>14146M</b>	208	<b>156M</b>	149
<b>115-SV</b>	261	<b>13301X</b>	186	<b>14147M</b>	208	<b>157HE</b>	151, 293
<b>115G</b>	165	<b>13305M</b>	187	<b>141P</b>	136	<b>157PE</b>	151, 293
<b>115G-FR</b>	261	<b>13306M</b>	187	<b>141S</b>	136	<b>157S</b>	151
<b>117</b>	168	<b>13310M</b>	188	<b>14201M</b>	283	<b>157T</b>	151, 293
<b>119</b>	165	<b>13322A</b>	198	<b>14207M</b>	218	<b>15770</b>	220
<b>120</b>	168	<b>13325</b>	188	<b>14208M</b>	218	<b>158</b>	277
<b>1201</b>	136	<b>13333AL</b>	197	<b>14209M</b>	217	<b>160K</b>	138
<b>1202</b>	147	<b>13344A</b>	198	<b>14210M</b>	217	<b>16101M</b>	287
<b>1203</b>	143	<b>13365M</b>	188	<b>14210T</b>	217	<b>16102M</b>	288
<b>1206</b>	144, 278	<b>13400-WN</b>	185	<b>14210X</b>	217	<b>16106</b>	227
<b>1210E</b>	279	<b>13400A</b>	182	<b>14218M</b>	284	<b>16106-16</b>	227
<b>1212</b>	280	<b>13400AG</b>	182	<b>14241M</b>	218	<b>16107</b>	228
<b>12137E</b>	161	<b>13400M</b>	182	<b>14242M</b>	218	<b>16107-22</b>	228
<b>12139</b>	157, 180	<b>13400M-FR</b>	259	<b>14245M</b>	218	<b>16134</b>	167
<b>12140</b>	159, 180	<b>13400MG</b>	182	<b>14300A</b>	203	<b>16201A</b>	230
<b>12142-F6.3</b>	161, 180	<b>13401A</b>	183	<b>14300G</b>	205	<b>16201M</b>	230
<b>121H</b>	160	<b>13401LH</b>	185	<b>14300G-FR</b>	260	<b>16245M</b>	230
<b>121P</b>	160	<b>13401M</b>	183	<b>14300M</b>	203	<b>162E</b>	299
<b>121T (IP)</b>	161	<b>13401MS</b>	183	<b>14300M-FR</b>	260	<b>162RK</b>	307
<b>121T (T)</b>	160	<b>13405A</b>	182	<b>14301A</b>	204	<b>16300A</b>	224
<b>121T (TH)</b>	161	<b>13405M</b>	182	<b>14301M</b>	204	<b>16300M</b>	224
<b>12222AL</b>	181	<b>13406A</b>	183	<b>14301X</b>	203	<b>16301A</b>	225
<b>12233A</b>	181	<b>13406M</b>	183	<b>14305M</b>	204, 281	<b>16301M</b>	225
<b>12300G</b>	180	<b>13410M</b>	184	<b>14306M</b>	204	<b>16301X</b>	224
<b>12300M</b>	180	<b>13425</b>	184	<b>14310M</b>	205	<b>16305M</b>	225, 275

16310M	226	18301A	235	2310M	044	2763	052
16316A	290	18301M	235	2325	044	2768J	053
16316M	290	18301X	234	23300A	266	2768P	053
16317A	290	18310M	235	23300M	266	2768RK	306
16317M	290	18316A	290	23305M	266	2769H	053
16325	226	18316M	290	23310M	266	2769N	053, 174
16400A	221	18317A	290	23325	266	2769NWF	053, 174
16400M	221	18317M	290	23400A	265	2770	054
16401A	222	183H	166, 193, 210, 250	23400M	265	2771	054
16401M	222	183T (IP)	166, 194, 211, 250	23405M	265	2771Z	026
16405A	221	183T (T)	166, 194, 211, 250	23410M	265	2772Z	026
16405M	221	183X (XZN)	167, 194, 211, 251	23425	265	2774J	051
16410M	222	18400A	231	2350G-12PSG	273	2774JS	051
16425	223	18400M	231	2350M	044	2774JS-3/8	082
16425-EPL	223	18401A	232	2350X	042	2774N	051
165BM	162	18401M	232	23760	266	2774P	051
165LM	162	18405A	232	2400A	040	2774P-1/4HF	157
16644A	229	18405M	232	2400M	040	2774P-5/16HF	159
16655A	229	18405M (D)	233	2400MZ	023	2774PS	051
16666AL	229	18410M	233	2400W-BA	041	2774PS-3/8	082
16688A	229	186	168	2405A	040	2780	054
166P	172	18760	238	2405M	040	2785	054
166PS/6	172	18770	238	2410M	041	280PM	283
166S	172	18771	238	2415A	041	3000 (PH)	070
167A	170	18866A	239	2415M	041	3000 (PZ)	070
167C (2B)	170	18877A	239	2425	042	3005	070
167C/3-2B	170	18888AL	238	24300A	268	3010A	071
167M	170	19300M	245	24300M	268	3010M	071
16760	228	19400A	244	24305M	268	3010MZ	030
16770	229	19400M	244	2430M	046	3011M	073
16771	229	19760	245	2430T	046	3012A	072
168C	173	19770	245	24310M	268	3012M	072
168CS	173	19977A	245	24400A	267	3012M-25	072, 277
168H-B	171	2000 (PH)	046	24400M	267	3015M	073
168P	173	2000 (PZ)	046	24405M	267	3020	074
168P (PZ)	171	2000Z	024	2440M	045	3025 (IP)	077
168PS/6	173	2005	046	2440M	045	3025 (IPR)	078
168S	173	2005Z	024	2440T	045	3025 (T)	075
168T (250)	280	2010A	047	24410M	267	3025 (TH)	076
168T (IP)	305	2010M	047	2441M	045	3025-100R (T)	075
168T (TH)	171	2010MZ	024	2445A	045	3025-100R (TH)	076
168T/7 (TH)	171	2011M	047	2445M	045	3025Z	030
169	280	2020	047	24425	267	3027	078
169/2	280	2025 (IP)	049	2450MS	042	3110A	079, 276
169BP	280	2025 (IPR)	049	24760	268	3110M	079, 276
169HR	280	2025 (T)	048	2715	152	3112G	154
169HR/2	280	2025 (TH)	048	2725RK	305	3112RK	306
169WM	280	2025Z	025	2725RK-3/8	305	3116M	150
170S	301	2120	052	2725Z	025	3117M	069
171	301	2127	139	2725Z-3/8	031	3119	079, 299
17108	242	2137	049, 157	2726Z	025	3127	139
17108-32	242	2138	049, 159	2726Z-3/8	031	3128 (L80)	139
171B-1/2	301	22300A	264	2749P-1/4HF	157	3129	141
171S	301	22300M	264	2749P-3/8	080	3131A	138
171SB-1/2	301	2233A	054	2749P-5/16HF	159	3131E	138
172	301	22400M	264	2749PS-3/8	080	3132	138
17300A	241	22425	264	2749RK	304	3137	079, 157
17300M	241	2251A	055	2749RK-3/8	304	3138	079, 159
17400A	240	2251M	055	2753J	050	3201AMW	089, 294
17400M	240	2254M	147	2753JB	050	3206AM	089
17405A	241	2258M	055	2753NB	050	3210A	089
17405M	241	2259M	056	2753N	050	3210M	089
17760	243	2263A	056, 294	2753NB	050	3216	090
17770	243	2275	056	2753P	050	3217M	090
17788A	243	2276	056	2753PB	050	3225A	272
17799A	243	2277	056	2753PS	050	3247	076, 279
180M	157	2285ZE	027	2753RK	304	3250M	090
18101M	287	2286Z	027	2755	051	3251	091
18102M	288	2300A	043	2755RK	306	3252M	091
18104M	235	2300M	043	2756	051	3264	138
18106	236	2300MZ	023	2756Z	026	3275	091
18106-16	236	2300W-BA	044	2756Z-1/2	026	3277	091
18107	237	2300X	042	2756Z-3/8	026	3278	091
18107-22	237	2300XZ	023	2760	052	3325	065
18300A	234	2305A	043	2760Z	026	3285Z	034
18300M	234	2305M	043	2762	052	3285ZA	034

# Numerical Index

3285ZE	034	3749S-1/2	108	4100M	134	4425 (EPL)	095
3286Z	034	3749SB	080	4100MRK	307	4425-N	094, 281
3300A	063	3749SB-1/2	108	4101	107, 281	4433A	115
3300C	270, 271	3749SBRK-1/2	304	4102	277	4440A	100
3300CB	270	3749SRK-1/2	304	4103M	137	4440M	100
3300CZ	029	3751J	272	4104	136	4440T	100
3300FN	065, 274	3751N	272	4109M	276	4445A	100
3300M	063	3752J	081	4110A	107, 276	4445M	100
3300M (L120)	066	3752N	081	4110M	107, 276	4450M	096
3300M/4-L120	066, 279	3752RK	305	4111M	276	4466A	115
3300MZ	029	3753BRK	304	4112G	154	4711X	153, 282
3300S	270	3753J	081	4112N	154	4715	153
3300W	064	3753JB	082	4112RK	306	4715S	153
3300X	062	3753N	081	4117M	099	4715SL	153
3300XA	062	3753NB	082	4122	274	4725RK	305
3300XZ	028	3753P	081	4127	140	4725Z	035
3305A	063	3753PB	082	4128 (L120)	140	4747	115
3305M	063	3753RK	304	4129	141	4749J-380	111
3305M (L120)	066	3753SM	080	4132	138	4749N-380	111
3305M/4-L120	066	3753SMB	080	4133	274	4749RK	304
3305P	270, 271	3755	085	4137	107, 157	4750BRK	304
3305PZ	029	3755RK	306	4138	107, 159	4750J	109
3305W	064	3756	085	4202	277	4750JB	109
3305X	062	3756Z	033	4203M	137	4750N	109
3305XA	062	3756Z-1/2	033	4203MF	137	4750NB	109
3310M	064	3756ZS	033	4211A	134	4750P	109
3322A	088	3757	085	4211M	134	4750PB	109
3322AZ	033	3760	086	4214M	134	4750RK	304
3340C	271	3760Z	032	4223M	116	4752J	108
3340M	068	3762	085	4238AM	116, 294	4752N	108
3341G	273	3763	086	4241A	117	4752RK	305
3342G	273	3768J	087	4241M	117	4753BRK	304
3344A	088	3768P	087	4249M	117	4753J	110
3345P	271	3768RK	306	4250M	117	4753JB	110
3350M	065	3768Z	032	4251A	118, 294	4753N	110
3350M (L120)	066	3768ZRK	306	4251M	118	4753NB	110
3350M/2-L120	066, 279	3769H	087	4252M	118	4753P	110, 111
3350X	062	3769N	087, 174	4254	118	4753PB	110
3400A	058	3769NWF	087, 174	4262M	118	4753RK	304
3400LH	060	3770	088	4272AM	119	4755	112
3400M	058	3771	088	4275	119	4755RK	306
3400M-24	277	3771Z	033	4276	119	4756	112
3400MZ	028	3772Z	033	4277	119	4756Z	036
3400W	059	3774J	083	4282	278	4760	113
3405A	058	3774JB	083	4285Z	036	4760Z	035
3405M	058	3774JBL	084	4285ZE	036	4763	113
3405W	059	3774JL	083	4300A	097	4768J	112
3410M	059	3774N	083	4300C	270	4768P	112
3415A	060	3774NB	083	4300H	275	4768RK	306
3415M	060	3774NL	083	4300H (8P)	275	4768Z	035
3425	060	3774P	083	4300M	097	4768ZRK	306
3425 (2B)	061	3774P-SR	084	4300M (L110)	282	4770	114
3430M	069	3774PB	083	4300M (L120)	099	4771	114
3440A	067	3774PL	083	4300M (L60)	282	4771Z	036
3440M	067	3774PS	082	4300S	270	4772Z	036
3440T	068	3776J	084	4305A	097	4774J	111
3441M	068	3776N	084	4305M	097	4774JB	112
3445A	067	3776P	084	4310M	098	4774N	111
3445M	067	3780	088	4325	098	4774NB	112
3445W	067	3785	088	4325 (L140)	099	4774P	111
3450M	061	4000 (PH)	100	4325 (L140)-2B	099	4774PB	112
3450MH	061	4000 (PZ)	100	4340C	271	4780	114
3701	272	4005	100	4400A	093	4781N	114
3715	152	4010A	101	4400LH	096	4785	114
3715S	152	4010M	101	4400M	092	4788	115
3715SL	152	4010M (12P)	275	4400M (DU)	292	6012M	121
3715SLK	152	4012A	103	4400MZ	035	6100M	135
3716	152	4012M	102	4400W	094	6100MRK	307
3725RK	305	4012M-43	102, 292	4401M	092	6101	121, 281
3725Z	031	4020	104	4405A	093	6102M	288
3725ZS	031	4020 (MH)	276	4405M	092	6112	154
3726Z	032	4025 (IP)	106	4405M (DU)	292	6112RK	306
3726ZS	032	4025 (T)	105	4405W	094	6201A	125
3749BRK	304	4027	106	4406M	092	6201M	125
3749RK	304	4100A	134	4410M	094	6212M	125
3749S	080	4100ARK	307	4425	095	6300A	121



6300M	121	D3753J	081	RS2127/10	139	RS3405A/9	058
6305A	121	D4753J	110	RS2127/6	139	RS3405M/12	058
6305M	121	ENH2003	055	RS2300A/9	043	RS3405W/7	059
6400A	120	ESH2001	055	RS2300M/12	043	RS3410M/12	059
6400M	120	ESH3001	089	RS2300MZ/12	023	RS3425/4 (2B)	061
6405A	120	ETH3001	089	RS2300X/12	042	RS3425/9	060
6405A (MV)	292	HA001	300	RS2300XZ/9	023	RS3430M/6	069
6405M	120	HA003	300	RS2305A/9	043	RS3440A/8	067
6425	120	NV13134	251	RS2305M/12	043	RS3440M/8	067
6644A	124	NV13145	249	RS2310M/12	044	RS3440T/8	068
6688A	124	NV13400	249	RS2350M/4	044	RS3441M/5	068
6749	122	NV13760	249	RS2350X/4	042	RS3445W/7	067
6749RK	304	NV14134	251	RS2400A/9	040	RS3450M/8	061
6752	122	NV14145	252	RS2400M/12	040	RS3450MH/6	061
6752RK	305	NV14400	252	RS2400MZ/12	023	RS3X00MZ/12	029
6755	123	NV14433A	252	RS2400W/9-BA	041	RS4010A/10	101
6755RK	306	NV14760	252	RS2405A/9	040	RS4010M/10	101
6760	123	NV16400	253	RS2405M/12	040	RS4012A/10	103
6768	123	NV16760	253	RS2410M/12	041	RS4012M/10	102
6768RK	306	P2201AM	057	RS2425/6	042	RS4020/6	104
6770	124	P2251M	057	RS2445A/9	045	RS4025/9	105
6785	124	P2258M	057	RS2450MS/6	042	RS4025/9-IP	106
6788	124	P2285Z	027	RS3010A/8	071	RS4027/7	106
8012M	127	P4241M	116	RS3010M/8	071	RS4127/6	140
8102M	288	PK166PS/6	172	RS3010MZ/8	030	RS4129/5	141
8225M	130	PK168PS/6	173	RS3012A/8	072	RS4300A/10	097
8400A	126	PK2346/6	088	RS3012M/8	072	RS4300M/10	097
8400M	126	PK2760/6	052	RS3015M/8	073	RS4300M/12	097
8405A	126	PK2763/6	052	RS3020/6	074	RS4305A/10	097
8405M	126	PK3760/6	086	RS3020/7	074	RS4305M/10	097
8749	128	PK3763/6	086	RS3025/8	075	RS4310M/10	098
8749RK	304	PK4760/5	113	RS3025/8-IP	077	RS4325/7	098
8760	127	PK4763/5	113	RS3025/8-L100R	075	RS4400A/10	093
8768	128	PS6	289	RS3025/8-L100RH	076	RS4400LH/6	096
8768RK	306	PS8	289	RS3025/9-HOLE	076	RS4400MZ/10	035
8770	127	PW6	289	RS3025/9-IPR	078	RS4400W/8	094
8785	128	PW8	289	RS3025Z/8	030	RS4401M/10	092
8788	128	PW8L	289	RS3027/5	078	RS4405A/10	093
8866A	127	PW8P	289	RS3127/8	139	RS4405W/8	094
AG112A	155	PW8P/4	289	RS3129/6	141	RS4406M/10	092
AG112F	155	R810	145	RS3300A/9	063	RS4410M/10	094
AG112H	155	R810A	148	RS3300FN/8	065, 274	RS4425/6-EPL	095
AG318A	155	R810B	148	RS3300M/12	063	RS4425/6-N	094, 281
AN112A	155	R810C	148	RS3300MZ/12	028	RS4425/7	095
AN112C	155	R810D	148	RS3300MZ/8	029	RS4450M/10	096
AN14300	284	R810E	148	RS3300W/7	064	RSAL	034
AS2305A	043	RS13012M/8	192	RS3300X/8	062	RSAL200	034
AS2405A	040	RS13025/8	192	RS3300XA/9	062	RSAL300	034
AS2445A	045	RS13301X/9	186	RS3300XZ/12	028	RSAS2305A/10	043
BD004	299	RS13401M/9	183	RS3300XZ/8	028	RSAS2405A/10	040
BD008E	297	RS13401MS/5	183	RS3305A/9	063	RSX025/11-IP	077
BD011SE	297	RS14012M/10	209	RS3305M/12	063	RSX025/11-IPR	078
BD014E	296	RS14025/6	209	RS3305W/7	064	RSX425/14	060
BD014E-140	296	RS14124/7	285	RS3305X/8	062	S3240A	090
BD014E-SF	297	RS14301X/10	203	RS3305XA/9	062	S3240M	090
BD014SE	296	RS14401M/10	200	RS3310M/12	064	S4240A	116
BD014XE-SF	297	RS14401MS/10	201	RS3325/9	065	S4240M	116
BD016E	298	RS14405M/11	199	RS3340M/8	068	SP4122	274
BD016JE	298	RS2010A/8	047	RS3350M/5	065	SP4300M	274
BD017E	298	RS2010M/7	047	RS3350X/4	062	SP4305M	274
BD018	299	RS2025/7	048	RS3400A/9	058	ST4027-140	275
BD022-120P	300	RS2025/7-HOLE	048	RS3400LH/7	060	TI4261M	132
BD023E	300	RS2025/7-IP	049	RS3400M/12	058		
BD024E	300	RS2025/7-IPR	049	RS3400MZ/12	028		
BD14400MJ	298	RS2025Z/7	025	RS3400MZ/8	028		
CLIP.P/5	034	RS20XXZ/9	024	RS3400W/7	059		

Reproduction in whole or in part without proper and prior authorization is prohibited.  
Der Nachdruck, im ganzen oder auch auszugsweise, bedarf unserer ausdrücklichen,  
vorherigen Genehmigung.

La reproduction de ce catalogue en tout ou en partie sans autorisation préalable est  
interdite.

本商品目錄之全部版權,係歸於株式會社山下工業研究所(Koken TOOL CO., LTD.)所有,不論其部分或  
全部,未經本公司許可,均不得複製

