

**Z-SERIES
Z-SERIE
SERIES-Z**

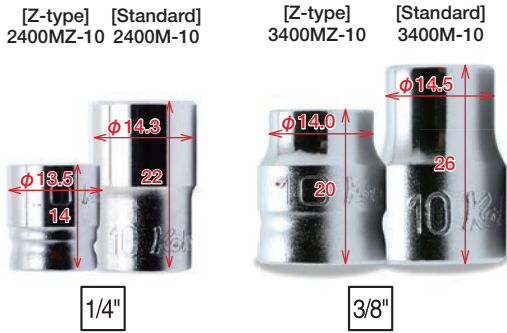

Z-Series : Feature



COMPACT

2400MZ and 3400MZ are designed 5-9mm shorter than standard 2400M and 3400M which is ideal for working in confined and tight areas.

2400MZ und 3400MZ sind gegenüber unseren Standardausführungen 2400M und 3400M um 5-9mm kürzer. Dies erlaubt ein Arbeiten an schwer zugänglichen Stellen.

Les douilles 2400MZ et 3400MZ étant plus courtes de 5-9mm par rapport aux douilles standards, elles ont l'avantage de faciliter le travail dans des endroits étroits et difficilement accessibles.

TOLERANCE-Hexagon Opening

The Hexagon openings of our Z-Sockets are produced with reduced tolerances (according to DIN/ISO) which achieve a more positive fit between bolt and socket.

Die Steckschlüsselöffnungen der Z-Serie werden mit geringeren Toleranzen (nach DIN/ISO) gefertigt um eine bessere, direktere Verbindung zwischen Schraube und Werkzeug zu gewährleisten.

Les douilles Ko-ken de la série Z sont fabriquées selon DIN/ISO comme toutes les douilles standards. Sauf que pour la série Z les tolérances sont plus restreintes afin d'atteindre un meilleur ajustement entre douille et vis.

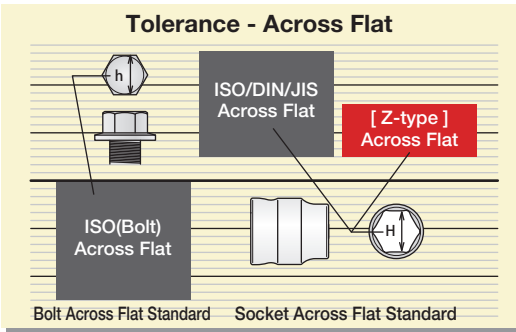

TOLERANCE-Square Drive

To ensure a tighter fit between socket and handle, the male and female square drives are produced with shorter tolerances (according DIN/ISO).

Auch die Antriebsvierkante sind mit einer geringeren Toleranz (nach DIN/ISO) gefertigt um eine festere Verbindung zwischen Betätigungswerkzeug und Steckschlüssel zu ermöglichen.

Aussi les carrés mâles et femelles sont fabriqués avec des tolérances plus restreintes (selon DIN/ISO) afin de garantir une meilleure fixation entre cliquet et douille.

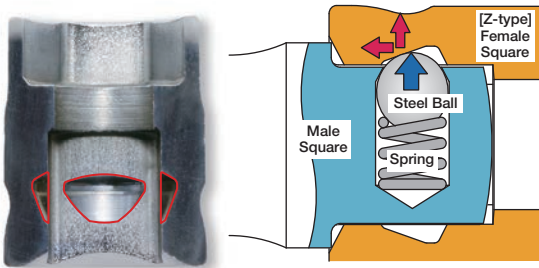
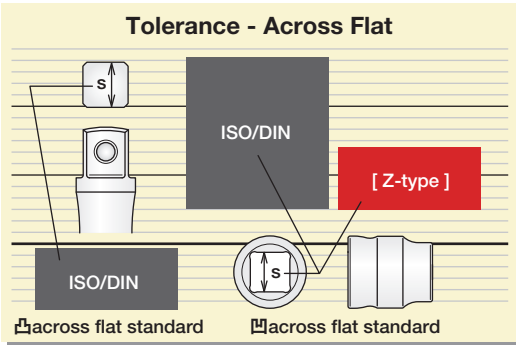

BALL HOLDING GROOVE

The inventive Ball Holding system of the Z-series allows a secure connection between Socket and Handle.

Die Werkzeuge der Z-Serie verfügen über spezielle Kugelfangrillen, die eine noch sicherere Verbindung zwischen Betätigungswerkzeug und Steckschlüssel gewährleisten.

La série Z dispose d'une rainure de fixation pour bille spéciale, qui améliore nettement la fixation entre douille et cliquet.

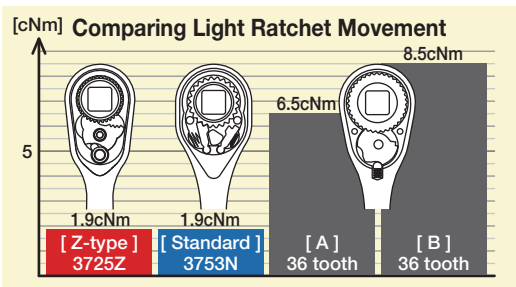

* A, B : Other Brand

RATCHET HANDLE

Smaller head with 36 tooth gear and light ratchet movement allow working in narrow spaces and confined areas.

Der schmalere Knarrenkopf, mit leicht gängigem 36-Zahn Getriebe erlaubt ein Arbeiten an engen schwer zugänglichen Stellen.

La tête de cliquet réduit et un mécanisme à 36 dents plus léger facilite le travail dans des endroits difficilement accessibles.

2400MZ (mm)	D ₁ (mm)	D ₂ (mm)	H (mm)	L (mm)	(g)	(pcs.)
4	6.4	11	3	14	6	10
4.5	7	11	3	14	6	10
5	7.6	11	3	14	6	10
5.5	8.2	11	3.5	14	6	10
6	8.8	11	3.5	14	6	10
7	9.9	11	3.5	14	6	10
8	11.1	11.7	4.5	15	7	10
10	13.5	12.5	7	15	8	10
11	14.7	13.2	7	15	9	10
12	15.9	14.4	7	15	11	10
13	17.1	15.6	7	15	14	10
14	18.3	16.8	7	15	16	10

RS2400MZ/12	12 Pieces Set/Rail 200mm	(g)
4, 4.5, 5, 5.5, 6, 7, 8, 10, 11, 12, 13, 14		228

2300XZ (mm)	D ₁ (mm)	D ₂ (mm)	H ₁ (mm)	H ₂ (mm)	L (mm)	(g)	(pcs.)
5.5	8.2	11	6	20	30	10	10
6	8.8	11	7	20	30	10	10
7	9.9	11	8	20	30	11	10
8	11.1	11.7	9	20	30	13	10
10	13.5	12.5	11	20	30	16	10
11	14.7	13.2	12	20	30	19	10
12	15.9	14.4	13	20	30	22	10
13	17.1	15.6	14	20	30	26	10
14	18.3	16.8	14	20	30	30	10

RS2300XZ/9	9 Pieces Set/Rail 200mm	(g)
5.5, 6, 7, 8, 10, 11, 12, 13, 14		290

2300MZ (mm)	D ₁ (mm)	D ₂ (mm)	H ₁ (mm)	H ₂ (mm)	L (mm)	(g)	(pcs.)
4	6.4	11	5	41	50	14	10
4.5	7	11	5.5	41	50	16	10
5	7.6	11	6	41	50	16	10
5.5	8.2	11	6.5	41	50	16	10
6	8.8	11	7	41	50	17	10
7	9.9	11	8	41	50	20	10
8	11.1	11.7	9	41	50	22	10
10	13.5	12.5	11	41	50	29	10
11	14.7	13.2	12	41	50	33	10
12	15.9	14.4	13	41	50	40	10
13	17.1	15.6	14	41	50	45	10
14	18.3	16.8	16	41	50	51	10

RS2300MZ/12	12 Pieces Set/Rail 200mm	(g)
4, 4.5, 5, 5.5, 6, 7, 8, 10, 11, 12, 13, 14		445

2400MZ 6-point Sockets 6-kant Steckschlüssel Douilles 6-pans

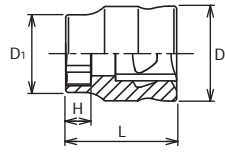

RS2400MZ/12 Socket Set on magnetic Rail Steckschlüsselsatz auf Magnetschiene Jeu de douilles sur rail à aimant



2300XZ 6-point Sockets, Semi-Deep 6-kant Steckschlüssel, mittel-lang Douilles, semi-profondes 6-pans

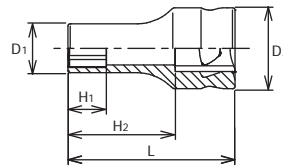

RS2300XZ/9 Socket Set on magnetic Rail Steckschlüsselsatz auf Magnetschiene Jeu de douilles sur rail à aimant

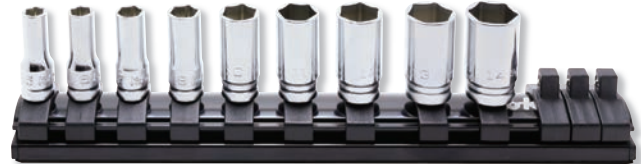

2300MZ 6-point Deep Sockets 6-kant-Steckschlüssel, lang Douilles longues 6-pans

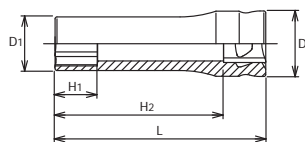

RS2300MZ/12 Socket Set on magnetic Rail Steckschlüsselsatz auf Magnetschiene Jeu de douilles sur rail à aimant



Z-SERIES
HAND
TITANIUM
SCREWDRIVERS
ACCESSORIES
IMPACT
SLEEVE-DRIVE
PROTECTOR
INDUSTRIAL
AUTOMOTIVE
MOTORCYCLE
CONSTRUCTION
SPARE PART

2000Z-28 / -50

⊕ Phillips Bit Sockets
Steckschlüssel für Kreuzschlitzschrauben Phillips
Douilles tournevis pour vis à empreinte Phillips

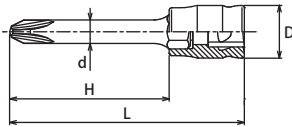

2000Z-28 (PH)	D (mm)	H (mm)	L (mm)	(g)	(pcs.)
1	11.2	12	28	9	10
2	11.2	12	28	10	10
3	11.2	12	28	10	10

2000Z-50 (PH)	D (mm)	d (mm)	H (mm)	L (mm)	(g)	(pcs.)
1	11.2	4	34	50	11	10
2	11.2	5	34	50	13	10
3	11.2	-	34	50	16	10

2005Z-25

⊖ Bit Sockets for Slotted Head
Steckschlüssel für Schlitzschrauben
Douilles tournevis pour vis à fente

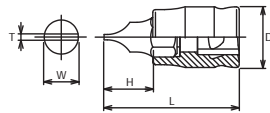

2005Z-25	T x W (mm)	D (mm)	H (mm)	L (mm)	(g)	(pcs.)
5	1.0 x 5.5	11.2	9	25	9	10
6	1.2 x 6.5	11.2	9	25	10	10

2010MZ-25 / -50

⦿ Inhex Bit Sockets
Steckschlüssel für Innensechskant-Schrauben
Douilles tournevis pour vis 6-pans creux

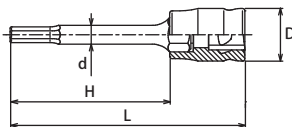

2010MZ-25 (mm)	D (mm)	H (mm)	L (mm)	(g)	(pcs.)
3	11.2	9	25	9	10
4	11.2	9	25	9	10
5	11.2	9	25	10	10
6	11.2	9	25	10	10

2010MZ-50 (mm)	D (mm)	d (mm)	H (mm)	L (mm)	(g)	(pcs.)
3	11.2	4	34	50	11	10
4	11.2	5	34	50	13	10
5	11.2	6	34	50	15	10
6	11.2	-	34	50	17	10

RS20XXZ/9

⊕ ⊖ ⦿ Socket Set on magnetic Rail
Steckschlüsselsatz auf Magnetschiene
Jeu de douilles sur rail à aimant



RS20XXZ/9		9 Pieces Set/Rail 200mm	(g)
2000Z.28		1, 2, 3	213
2005Z.25		5, 6	
2010MZ.25		3, 4, 5, 6	

1/4"

Z-series
Z-serie
Series-Z

2025Z-28 (T)	D (mm)	H (mm)	L (mm)	(g)	(pcs.)
T10	11.2	12	28	9	10
T15	11.2	12	28	9	10
T20	11.2	12	28	9	10
T25	11.2	12	28	10	10
T27	11.2	12	28	10	10
T30	11.2	12	28	10	10
T40	11.2	12	28	11	10

2025Z-50 (T)	D (mm)	d (mm)	H (mm)	L (mm)	(g)	(pcs.)
T10	11.2	4	34	50	11	10
T15	11.2	4	34	50	11	10
T20	11.2	4.5	34	50	12	10
T25	11.2	5	34	50	13	10
T27	11.2	5	34	50	13	10
T30	11.2	5.6	34	50	15	10
T40	11.2	-	34	50	17	10

RS2025Z/7-L28	7 Pieces Set/Rail 200mm	(g)
T10, T15, T20, T25, T27, T30, T40		195

RS2025Z/7-L50	7 Pieces Set/Rail 200mm	(g)
T10, T15, T20, T25, T27, T30, T40		220

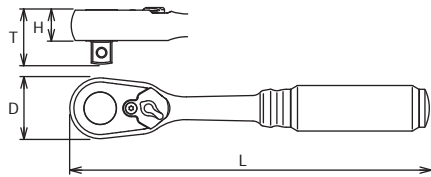

36

	D (mm)	T (mm)	H (mm)	L (mm)	(g)	(pcs.)
2725Z	20.5	17.1	9.5	114	79	2
2725Z-160	20.5	17.1	9.5	160	120	2

* Renewal Kits → 2725RK → P305



2725Z
2725Z-160
Reversible Ratchet
Knarre, verstellbar
Cliquet, réversible

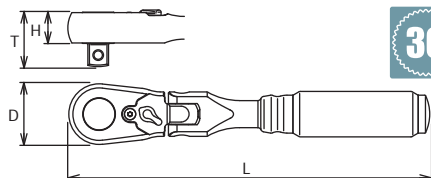

36
Flexible Head

	D (mm)	T (mm)	H (mm)	L (mm)	(g)	(pcs.)
2726Z	20.5	17.1	9.5	114	103	2
2726Z-160	20.5	17.1	9.5	160	150	2

* Renewal Kits → 2726RK → P305



2726Z
2726Z-160
Flexible Ratchet, Reversible (Short)
Gelenk-Knarre kurz, verstellbar
Cliquet articulé court, réversible

2025Z-28 / -50

TORX® Bit Sockets
TORX® Bit-Steckschlüssel
Douilles tournevis, TORX®

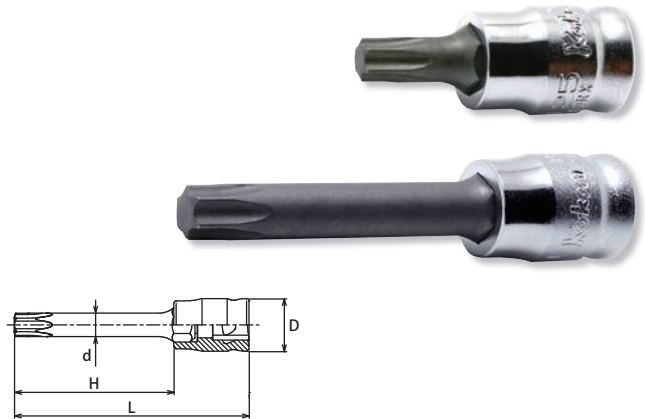

RS2025Z/7-L28 RS2025Z/7-L50

Socket Set on magnetic Rail
Steckschlüsselsatz auf Magnetschiene
Jeu de douilles sur rail à aimant



2760Z

Extension Bars
Verlängerungen
Rallonges

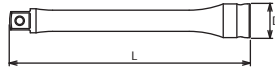

	D (mm)	L (mm)	(g)	(pcs.)
2760Z-50	11.5	50	21	10
2760Z-100	11.5	100	39	10
2760Z-150	11.5	150	58	10

2771Z

Universal Joint
Gelenk-Einsatz
Joint articulé



UNIVERSAL JOINT

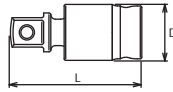

	D (mm)	L (mm)	(g)	(pcs.)
2771Z	11.7	29.9	15	10

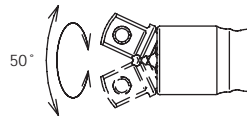

2772Z

Universal Double Joint
Doppelgelenk-Einsatz
Joint articulé double

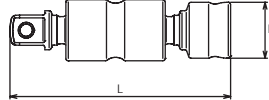

	D (mm)	L (mm)	(g)	(pcs.)
2772Z	11.7	46	26	10

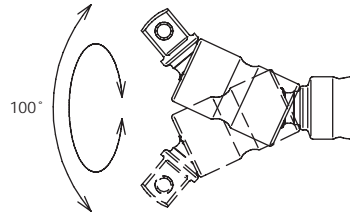

2756Z

Quick Spinner
Rändel-Drehscheibe
Lanceur



	D (mm)	L (mm)	(g)	(pcs.)
2756Z	20.3	18	15	10

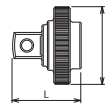

2756Z-3/8

2756Z-1/2

Quick Spinner, Adaptor
Rändel-Drehscheibe als Adaptor
Lanceur, adaptateur



2756Z-3/8

2756Z-1/2



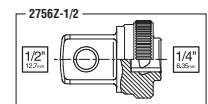
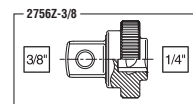
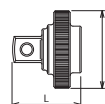





	D (mm)	L (mm)	(g)	(pcs.)
2756Z-3/8	20.3	21.5	24	10
2756Z-1/2	20.3	26	35	10



1/4"







Z-series
Z-serie
Series-Z

Z-SERIES
HAND
TITANIUM
ACCESSORIES
SCREWDRIVERS
IMPACT
SLEEVE-DRIVE
PROTECTOR
INDUSTRIAL
AUTOMOTIVE
MOTORCYCLE
CONSTRUCTION
SPARE PART

P2285Z		26 Pieces Set/△△=660g	
PLASTIC CASE:W245xH120xT45			
Sockets	Accessories		
 2400MZ 6-pt. Sockets 4, 4.5, 5, 5.5, 6, 7, 8, 10, 11,12, 13, 14		2725Z	
		2756Z	
 2000Z.28 1, 2, 3		2771Z	
 2005Z.25 5, 6		2760Z-50	
 2010MZ.25 3, 4, 5, 6		2760Z-150	



P2285Z Set in PE-foam tray
Steckschlüsselsatz in Weichschaumeinlage
Set disposé dans boîte de rangement en mousse souple

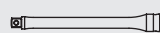

2286Z		17 Pieces Set/△△=780g	
BLACK METAL CASE:W240xH100xT32mm			
Sockets	Accessories		
 2400MZ 6-pt. Sockets 4, 5, 5.5, 6, 7, 8, 10, 11, 12, 13, 14		2725Z	
		2756Z	
		2771Z	
		2760Z-50	
		2760Z-100	
		2760Z-150	

2286Z Set in PE-foam tray
Steckschlüsselsatz in Weichschaumeinlage
Set disposé dans boîte de rangement en mousse souple



2285ZE		10 Pieces Set/△△=300g	
Rail 200mm/PLASTIC BAG			
Sockets	Accessories		
 2400MZ 6-pt. Sockets 5.5, 6, 7, 8, 10, 12, 13, 14		2725Z	
		2756Z	

2285ZE Socket Sets
Steckschlüssel Sätze
Jeu de clés à douilles



3400MZ

6-point Sockets
6-kant Steckschlüssel
Douilles 6-pans

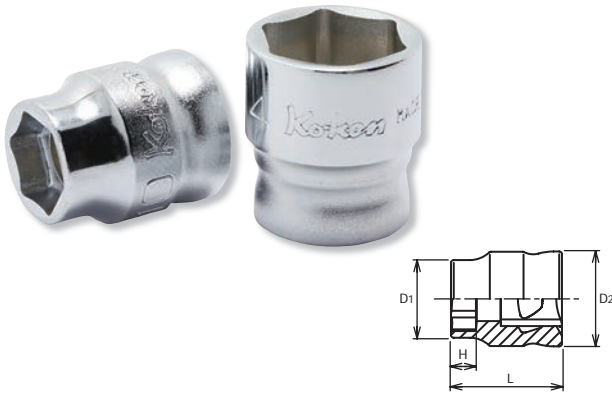

3400MZ (mm)	D ₁ (mm)	D ₂ (mm)	H (mm)	L (mm)	(g)	(pcs.)
5.5	8.5	17	3.5	19	16	10
6	9.1	17	3.5	19	17	10
7	10.3	17	3.5	19	17	10
8	11.5	17	4.5	20	17	10
10	14	17	4.5	20	18	10
11	15.3	17	5.5	21	18	10
12	16.5	17	5.5	21	19	10
13	17.8	17	8.5	21	19	10
14	19	17	8.5	21	20	10
15	20.2	18.2	8.5	21	24	10
16	21.3	19.3	8.5	21	28	10
17	22.5	20.5	8.5	21	32	10
18	23.6	21.6	9.5	22	38	10
19	24.8	22.8	9.5	22	41	10
21	27	25	10.5	23	51	10
22	28.3	26.3	10.5	23	58	10

3400MZ is designed 5-9mm shorter than standard 3400M.
Ideal for working in confined and tight areas.

RS3400MZ/8 RS3400MZ/12

Socket Set on magnetic Rail
Steckschlüsselsatz auf Magnetschiene
Jeu de douilles sur rail à aimant



RS3400MZ/8	8 Pieces Set/Rail 200mm	(g)
8, 10, 11, 12, 13, 14, 17, 19		320

RS3400MZ/12	12 Pieces Set/Rail 300mm	(g)
7, 8, 10, 11, 12, 13, 14, 15, 16, 17, 18, 19		490

3300XZ

6-point Sockets, Semi-Deep
6-kant Steckschlüssel, mittel-lang
Douilles, semi-profondes 6-pans

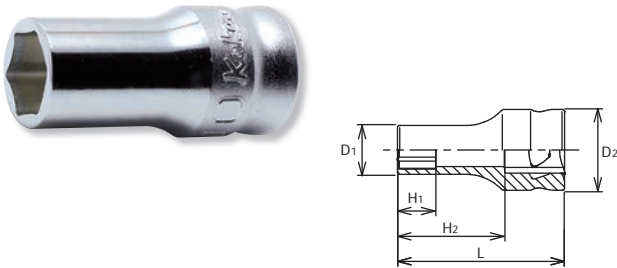

3300XZ (mm)	D ₁ (mm)	D ₂ (mm)	H ₁ (mm)	H ₂ (mm)	L (mm)	(g)	(pcs.)
7	10.3	17	8	23	35	23	10
8	11.5	17	9	23	35	24	10
10	14	17	11	23	35	26	10
11	15.3	17	12	23	35	28	10
12	16.5	17	13	23	35	29	10
13	17.8	17	14	23	35	32	10
14	19	17	16	23	35	34	10
15	20.2	18.2	16	23	35	40	10
16	21.3	19.3	16.5	23	35	45	10
17	22.5	20.5	16.5	23	35	50	10
18	23.6	21.6	16.5	23	35	56	10
19	24.8	22.8	18	23	35	60	10

RS3300XZ/8 RS3300XZ/12

Socket Set on magnetic Rail
Steckschlüsselsatz auf Magnetschiene
Jeu de douilles sur rail à aimant



RS3300XZ/8	8 Pieces Set/Rail 200mm	(g)
8, 10, 11, 12, 13, 14, 17, 19		420

RS3300XZ/12	12 Pieces Set/Rail 300mm	(g)
7, 8, 10, 11, 12, 13, 14, 15, 16, 17, 18, 19		630

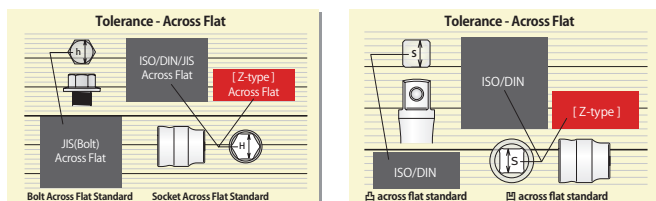

Manufacturing tolerance is precisely controlled to achieve a secure fitting.

BALL HOLDING GROOVE

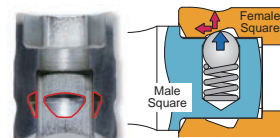

The inventive Ball Holding system of the Z-series allows a secure connection between Socket and Handle.

Die Werkzeuge der Z-Serie verfügen über spezielle Kugelfangrillen, die eine noch sicherere Verbindung zwischen Betätigungswerkzeug und Steckschlüssel gewährleisten.

La série Z dispose d'une rainure de fixation pour bille spéciale, qui améliore nettement la fixation entre douille et cliquet.

3300MZ (mm)	D ₁ (mm)	D ₂ (mm)	H ₁ (mm)	H ₂ (mm)	L (mm)	(g)	(pcs.)
7	10.3	17	8	41.5	55	29	10
8	11.5	17	9	41.5	55	34	10
10	14	17	11	41.5	55	43	10
11	15.3	17	12	41.5	55	45	10
12	16.5	17	13	41.5	55	49	10
13	17.8	17	14	41.5	55	52	10
14	19	17	16	41.5	55	55	10
15	20.2	18.2	16	40.5	55	65	10
16	21.3	19.3	17	40.5	55	74	10
17	22.5	20.5	18	40.5	55	83	10
18	23.6	21.6	19	39.5	55	90	10
19	24.8	22.8	20	39.5	55	95	10

RS3300MZ/8	8 Pieces Set/Rail 200mm	(g)
8, 10, 11, 12, 13, 14, 17, 19		600

RS3300MZ/12	12 Pieces Set/Rail 300mm	(g)
7, 8, 10, 11, 12, 13, 14, 15, 16, 17, 18, 19		900

RS3X00MZ/12	12 Pieces Set/Rail 300mm	(g)
3400MZ	8, 10, 11, 12, 13, 14, 17, 19	550
3300MZ	8, 10, 12, 14	

3300CZ (mm)	D (mm)	H (mm)	L (mm)	(g)	(pcs.)
14	18.4	11	70	67	10
16	20.5	13	70	71	10
18	22.9	12	70	75	10
20.8	26.3	13.5	70	105	10

Slim & light weight body with smaller outside diameter for work in tight spaces.

⚠ Spring clip type spark plug sockets caused deforming the clip if it would be used with shallow engagement.



3305PZ (mm)	D (mm)	H (mm)	L (mm)	(g)	(pcs.)
14	17.9	8	70	56	10
16	20	8	70	55	10

Spark Plug Socket with Magnet, 12-pt. opening: size 14mm



⚠ The magnet could be broken with any impacts. Please handle with care.

3300MZ

6-point Deep Sockets
6-kant-Steckschlüssel, lang
Douilles longues 6-pans

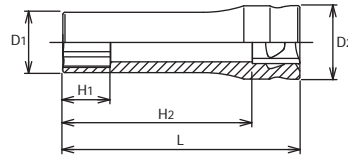

RS3300MZ/8

Socket Set on magnetic Rail
Steckschlüsselsatz auf Magnetschiene
Jeu de douilles sur rail à aimant

RS3300MZ/12



RS3X00MZ/12

Socket Set on magnetic Rail
Steckschlüsselsatz auf Magnetschiene
Jeu de douilles sur rail à aimant



3300CZ

Spark Plug Sockets with Spring Clips
Zündkerzen-Schlüssel mit Haltefeder
Douilles avec ressorts de retenues pour bougies

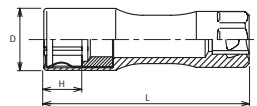

3305PZ

Spark Plug Socket with Magnet, 12-pt. opening
Zündkerzensteckschlüssel mit Magnet, 12-kant
Douille pour bougies, avec aimant, 12-pans

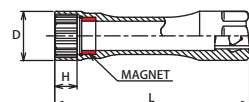

3010MZ-50 / -75

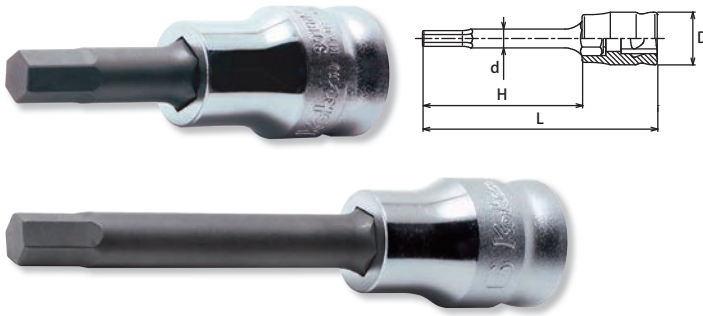

 Inhex Bit Sockets
Steckschlüssel für Innensechskant-Schrauben
Douilles tournevis pour vis 6-pans creux



3010MZ-50 (mm)	D (mm)	d (mm)	H (mm)	L (mm)	(g)	(pcs.)
3	17	4	23.5	50	28	10
4	17	5	23.5	50	29	10
5	17	6	23.5	50	30	10
6	17	7	23.5	50	35	10
7	17	-	23.5	50	38	10
8	17	-	23.5	50	40	10
10	17	-	23.5	50	50	10
12	19	-	23.5	50	70	10

3010MZ-75 (mm)	D (mm)	d (mm)	H (mm)	L (mm)	(g)	(pcs.)
3	17	6	48.5	75	33	10
4	17	6	48.5	75	35	10
5	17	6	48.5	75	36	10
6	17	7	48.5	75	41	10
7	17	7.9	48.5	75	45	10
8	17	-	48.5	75	48	10
10	17	-	48.5	75	65	10
12	19	-	48.5	75	90	10

RS3010MZ/8-L50 RS3010MZ/8-L75

  Socket Set on magnetic Rail
Steckschlüsselsatz auf Magnetschiene
Jeu de douilles sur rail à aimant



RS3010MZ/8-L50	8 Pieces Set/Rail 200mm	(g)
3, 4, 5, 6, 7, 8, 10, 12		460

RS3010MZ/8-L75	8 Pieces Set/Rail 200mm	(g)
3, 4, 5, 6, 7, 8, 10, 12		530

3025Z-50 / -75

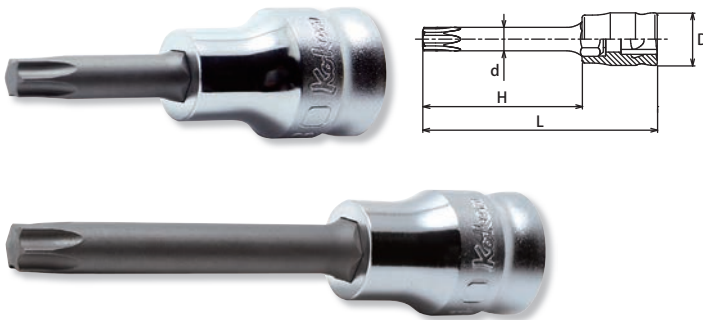

 TORX® Bit Sockets
TORX® Bit-Steckschlüssel
Douilles tournevis, TORX®



3025Z-50 (T)	D (mm)	d (mm)	H (mm)	L (mm)	(g)	(pcs.)
T10	17	3	23.5	50	27	10
T15	17	3.5	23.5	50	28	10
T20	17	3.9	23.5	50	28	10
T25	17	4.5	23.5	50	29	10
T27	17	5	23.5	50	30	10
T30	17	5.6	23.5	50	31	10
T40	17	6.7	23.5	50	35	10
T45	17	7.83	23.5	50	38	10
T50	17	8.90	23.5	50	48	10
T55	19	11.3	23.5	50	70	10

3025Z-75 (T)	D (mm)	d (mm)	H (mm)	L (mm)	(g)	(pcs.)
T20	17	4.5	48.5	75	32	10
T25	17	5	48.5	75	33	10
T27	17	5	48.5	75	33	10
T30	17	5.6	48.5	75	35	10
T40	17	6.7	48.5	75	41	10
T45	17	7.9	48.5	75	45	10
T50	17	8.9	48.5	75	55	10
T55	19	11.3	48.5	75	80	10

RS3025Z/8-L50 RS3025Z/8-L75

  Socket Set on magnetic Rail
Steckschlüsselsatz auf Magnetschiene
Jeu de douilles sur rail à aimant



RS3025Z/8-L50	8 Pieces Set/Rail 200mm	(g)
T20, T25, T27, T30, T40, T45, T50, T55		450

RS3025Z/8-L75	8 Pieces Set/Rail 200mm	(g)
T20, T25, T27, T30, T40, T45, T50, T55		480

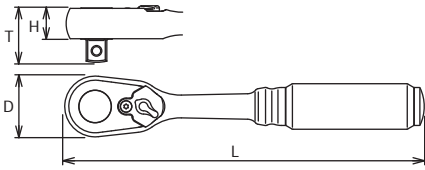

36

	D (mm)	T (mm)	H (mm)	L (mm)	(g)	(pcs.)
2725Z-3/8	20.5	20.5	9.5	114	83	2
New 2725Z-3/8 (L160)	20.5	20.5	9.5	160	120	2

* Renewal Kits → 2725RK-3/8 → P305

2725Z-3/8 2725Z-3/8 (L160)

Reversible Ratchet Short
Knarre kurz, verstellbar
Cliquet court, réversible

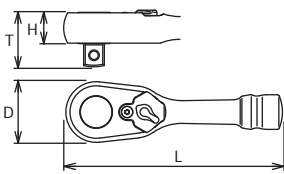

36

	D (mm)	T (mm)	H (mm)	L (mm)	(g)	(pcs.)
3725ZS	28	24.5	13.7	100	157	2

* Renewal Kits → 3725RK → P305

3725ZS

Reversible Ratchet Short
Knarre kurz, verstellbar
Cliquet court, réversible

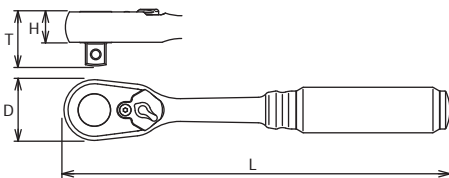

36

	D (mm)	T (mm)	H (mm)	L (mm)	(g)	(pce.)
3725Z	28	24.5	13.7	178	254	1
3725Z-280	28	24.5	13.7	280	360	1

* Renewal Kits → 3725RK → P305

3725Z 3725Z-280

Reversible Ratchet
Knarre, verstellbar
Cliquet, réversible

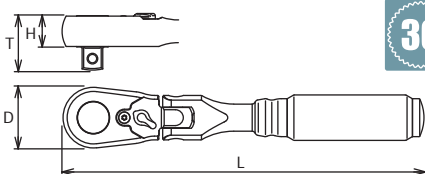

36  Flexible Head

	D (mm)	T (mm)	H (mm)	L (mm)	(g)	(pcs.)
2726Z-3/8	20.5	20.5	9.5	114	107	2
New 2726Z-3/8 (L160)	20.5	20.5	9.5	160	130	2

* Renewal Kits → 2725RK-3/8 → P305

2726Z-3/8 2726Z-3/8 (L160)

Flexible Ratchet, Reversible (Short)
Gelenk-Knarre kurz, verstellbar
Cliquet articulé court, réversible



3726ZS Flexible Ratchet, Reversible (Short)
Gelenk-Knarre kurz, verstellbar
Cliquet articulé court, réversible

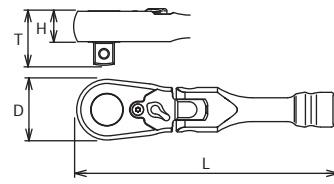

	D (mm)	T (mm)	H (mm)	L (mm)	(g)	(pcs.)
3726ZS	28	24.5	13.7	120	196	2

* Renewal Kits → **3725RK** → P305

3726Z
3726Z-280 Flexible Ratchet, Reversible
Gelenk-Knarre, verstellbar
Cliquet articulé, réversible

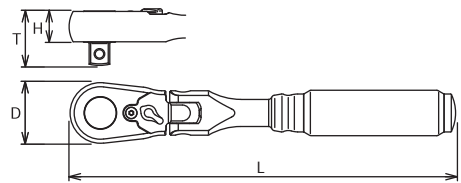

	D (mm)	T (mm)	H (mm)	L (mm)	(g)	(pcs.)
3726Z	28	24.5	13.7	178	317	1
3726Z-280	28	24.5	13.7	280	420	1

* Renewal Kits → **3725RK** → P305

3768Z-250
3768Z-400 Hinge Handle
Gelenkgriff
Poignée articulée

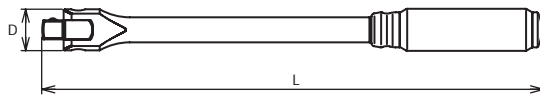

	D (mm)	L (mm)	(g)	(pcs.)
3768Z-250	20.5	250	309	5
3768Z-400	20.5	400	500	2

* Renewal Kits → **3768ZRK** → P306

3760Z Extension Bars
Verlängerungen
Rallonges

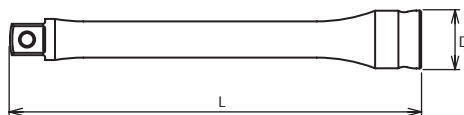

	D (mm)	L (mm)	(g)	(pcs.)
3760Z-75	17.5	75	66	10
3760Z-125	17.5	125	103	10
3760Z-250	17.5	250	195	5

	D (mm)	L (mm)	(g)	(pcs.)
3771Z	18	42.5	44	10



3771Z Universal Joint
Gelenk-Einsatz
Joint articulé

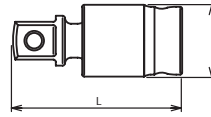
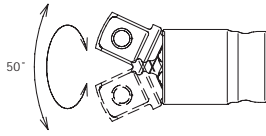

	D (mm)	L (mm)	(g)	(pcs.)
3772Z	17	65	76	10

3772Z Universal Double Joint
Doppelgelenk-Einsatz
Joint articulé double

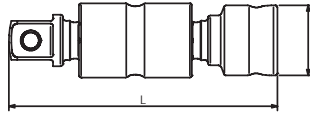
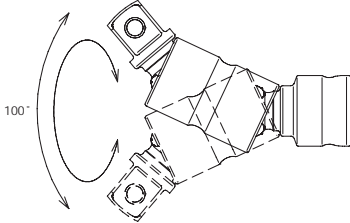

	D (mm)	L (mm)	(g)	(pcs.)
3756Z	28	25	40	10

Outside diameter is smaller compared to standard 3756.
Ideal for working in combination with 3725Z



3756Z Quick Spinner
Rändel-Drehscheibe
Lanceur

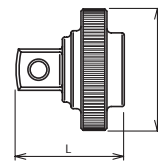

	D (mm)	L (mm)	(g)	(pcs.)
3756ZS	20.3	25	26	10

Ideal for working in combination with 2725Z-3/8 and 2726Z-3/8.

3756ZS Quick Spinner
Rändel-Drehscheibe
Lanceur

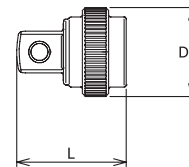

	D (mm)	L (mm)	(g)	(pcs.)
3756Z-1/2	28	29	52	10

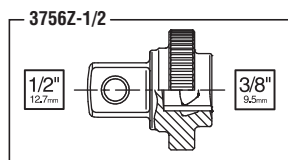

3756Z-1/2 Quick Spinner, Adaptor
Rändel-Drehscheibe als Adaptor
Lanceur, adaptateur

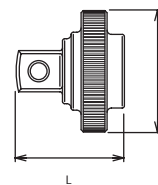

	D (mm)	L (mm)	(g)	(pcs.)
3322AZ-75	17.5	75	42	10

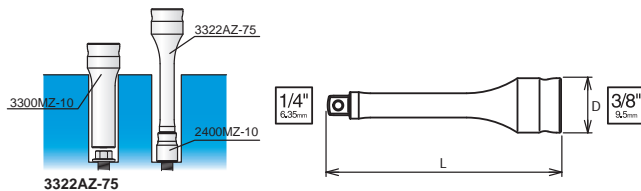

3322AZ-75 Extension Adaptor
Verlängerungsadapter
Reduction adaptateur-rallonge



Z-series
Z-serie
Series-Z

3/8"

Z-SERIES

HAND

TITANIUM

ACCESSORIES

SCREWDRIVERS

IMPACT

SLEEVE-DRIVE

PROTECTOR

INDUSTRIAL

AUTOMOTIVE

MOTORCYCLE

CONSTRUCTION

SPARE PART

3285Z Set in PE-foam tray
Steckschlüsselsatz in Weichschaumeinlage
Set disposé dans boîte de rangement en mousse souple



3285ZA Set in PE-foam tray
Steckschlüsselsatz in Weichschaumeinlage
Set disposé dans boîte de rangement en mousse souple



3286Z Set in PE-foam tray
Steckschlüsselsatz in Weichschaumeinlage
Set disposé dans boîte de rangement en mousse souple



3285ZE Socket Sets
Steckschlüssel Sätze
Jeu de clés à douilles



RSAL200  Magnetic Rail with retaining clips
Magnetschiene mit Halteklammern
RSAL300 Rail à aimant avec clips de maintien













RSAL Magnetic Rails and retaining Clips, bulk
Magnetschiene und Halteklammern, lose
CLIP.P/5 Rail à aimant avec clips de maintien, en vrac



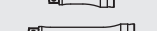



3285Z 26 Pieces Set/△=2,100g

PLASTIC TRAY:W390xT180xH25

Sockets	Accessories
 3400MZ 6-pt. Sockets 5.5, 6, 7, 8, 10, 12, 13, 14, 17, 19, 21, 22	 3725Z
 3300MZ 6-pt. Deep Sockets 8, 10, 12, 14	 3756Z
 3300CZ Spark Plug Sockets 14, 16, 20.8	 3771Z
	 3768Z-250
	 3760Z-75
	 3760Z-125
	 3760Z-250







3285ZA 15 Pieces Set/△=750g

PLASTIC TRAY:W300xT90xH25

Sockets	Accessories
 3400MZ 6-pt. Sockets 5.5, 6, 7, 8, 10, 12, 13, 14, 17, 19, 21, 22	 3725Z
	 3756Z
	 3771Z



3286Z 21 Pieces Set/△=2,600g

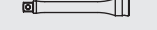

BLACK METAL CASE:W415xH120xT50mm



Sockets	Accessories
 3400MZ 6-pt. Sockets 7, 8, 10, 11, 12, 13, 14, 15, 16, 17, 18, 19, 21, 22	 3725Z
	 3756Z
	 3771Z
	 3768Z-250
	 3760Z-75
	 3760Z-125
	 3760Z-250

3285ZE 9 Pieces Set/△=600g

Rail 200mm/PLASTIC BAG

Sockets	Accessories
 3400MZ 6-pt. Sockets 8, 10, 12, 13, 14, 17, 19	 3725Z
	 3756Z

RSAL200		RAIL (mm)	CLIP (pcs.)	(g)	(pce.)
1/4x12		200	12	125	1
3/8x8		200	8	130	1





RSAL300		RAIL (mm)	CLIP (pcs.)	(g)	(pce.)
3/8x12		300	12	180	1
1/2x10		300	10	190	1



RAIL

	RAIL (mm)	(g)	(pce.)
RSAL200	200	110	1
RSAL300	300	145	1
RSAL400	400	210	1

CLIP

CLIP.P/5		(g)	(pcs.)
1/4		10	5
3/8		13	5
1/2		20	5

1/2"

Z-series
Z-serie
Series-Z

4400MZ (mm)	D ₁ (mm)	D ₂ (mm)	H (mm)	L (mm)	(g)	(pcs.)
8	12.6	20.6	4.5	26	30	10
10	15	20.6	4.5	26	31	10
12	17	20.6	5.5	27	32	10
13	18.3	21.5	6.5	28	40	10
14	19.5	21.5	6.5	28	40	10
16	22	21.5	7.5	29	43	10
17	23	22.5	7.5	29	49	10
18	24.1	23.7	7.5	29	56	10
19	25.3	24.4	9.5	29	62	10
21	27.6	26.3	10.5	29	76	10
22	28.8	27.5	11	29	83	10
24	31.1	29.2	12	29	96	5
27	34.6	32.2	13.5	30	124	5
30	38.1	35.2	14.5	31	156	5
32	40.4	36.8	15.5	32	178	5

4400MZ



6-point Sockets
6-kant Steckschlüssel
Douilles 6-pans

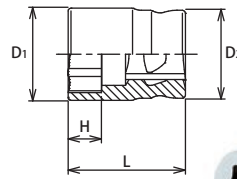

RS4400MZ/10	10 Pieces Set/Rail 300mm	(g)
10, 12, 13, 14, 17, 19, 21, 22, 24, 27		830

RS4400MZ/10



Socket Set on magnetic Rail
Steckschlüsselsatz auf Magnetschiene
Jeu de douilles sur rail à aimant



36

4725Z

Reversible Ratchet
Knarre, verstellbar
Cliquet, réversible



	D (mm)	T (mm)	H (mm)	L (mm)	(g)	(pce.)
4725Z	36.5	32.8	18.2	253	590	1

* Renewal Kits → 4725RK → P305

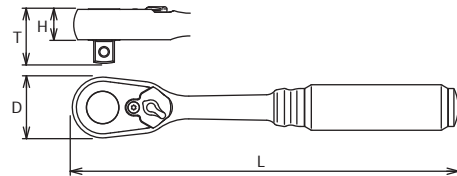

4768Z-430

Hinge Handle
Gelenkgriff
Poignée articulée



	D (mm)	L (mm)	(g)	(pce.)
4768Z-430	28	430	720	1

* Renewal Kits → 4768ZRK → P306

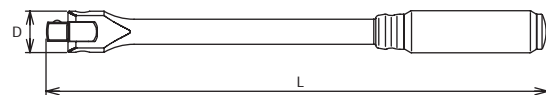

4760Z

Extension Bars
Verlängerungen
Rallonges

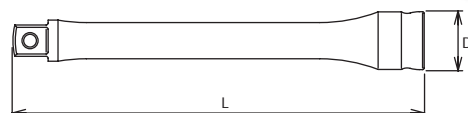

	D (mm)	L (mm)	(g)	(pcs.)
4760Z-125	22.5	125	180	5
4760Z-250	22.5	250	340	5

Z-SERIES
HAND
TITANIUM
ACCESSORIES
SCREWDRIVERS
IMPACT
SLEEVE-DRIVE
PROTECTOR
INDUSTRIAL
AUTOMOTIVE
MOTORCYCLE
CONSTRUCTION
SPARE PART

4771Z Universal Joint
Gelenk-Einsatz
Joint articulé

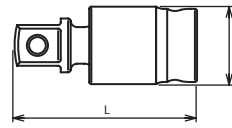

	D (mm)	L (mm)	(g)	(pcs.)
4771Z	23.7	55.8	100	10

4772Z Universal Double Joint
Doppelgelenk-Einsatz
Joint articulé double

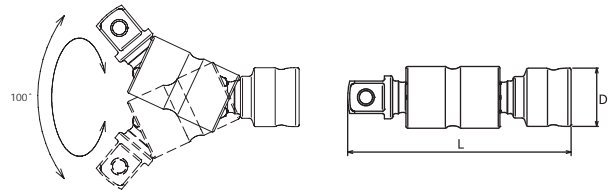

	D (mm)	L (mm)	(g)	(pcs.)
4772Z	23.7	87.2	170	5

4756Z Quick Spinner
Rändel-Drehscheibe
Lanceur

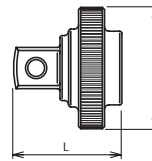

	D (mm)	L (mm)	(g)	(pcs.)
4756Z	36.3	33.5	84	10

4285Z Set in Foam tray
Steckschlüsselsatz in Weichschaumeinlage
Set disposé dans boîte de rangement en mousse souple

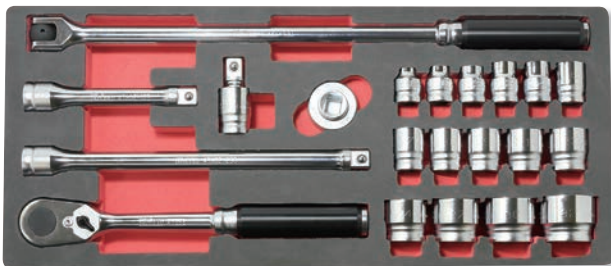

4285Z		21 Pieces Set/△=4,800g
METAL CASE:W445×T190×H50		
Sockets	Accessories	
4400MZ 6-pt. Sockets 8, 10, 12, 13, 14, 16, 17, 18, 19, 21, 22, 24, 27, 30, 32	4725Z	4756Z
	4771Z	4768Z-430
	4760Z-125	4760Z-250

4285ZE Socket Sets
Steckschlüssel Sätze
Jeu de clés à douilles



4285ZE		11 Pieces Set/△=1,380g
Rail 300mm/PLASTIC BAG		
Sockets	Accessories	
4400MZ 6-pt. Sockets 10, 12, 13, 14, 17, 19, 21,22, 24	4725Z	4756Z